



**Humphrey®** Field Analyzer 3 (HFA3)  
Instructions for Use – Models 830, 840, 850, 860



---

### **Copyright**

©2018 Carl Zeiss Meditec, Inc. All rights reserved.

### **Trademarks**

FastPac, FORUM, Guided Progression Analysis, GPA, Humphrey, HFA, Liquid Trial Lens, SITA, SITA Fast, SITA Faster, SITA Standard, SITA-SWAP, STATPAC, ReIYE, Visual Field Index, and VFI are either registered trademarks or trademarks of Carl Zeiss Meditec, Inc in the United States and/or other countries.

Windows, Windows Vista, and Windows Server are registered trademarks of Microsoft Corporation in the United States and/or other countries.

HP is a registered trademark of Hewlett-Packard Company.

Intel is a registered trademark of Intel Corporation.

Bonjour, the Bonjour logo, and the Bonjour symbol are trademarks of Apple Computer, Inc.

All other trademarks used in this document are the property of their respective owners.

### **Patents**

[www.zeiss.com/meditec/en\\_us/imprint/patents.html](http://www.zeiss.com/meditec/en_us/imprint/patents.html)

## Table of Contents

<b>(1) Introduction</b> .....	<b>1-1</b>
Operating Principles .....	1-1
Intended Use .....	1-1
Indications for Use .....	1-1
Purpose of This User Manual .....	1-3
Symbols and Labels .....	1-4
Instrument Disposition .....	1-6
Disposal .....	1-6
User Changes to Software or Hardware .....	1-6
Instrument Installation .....	1-7
HFA3 Licenses .....	1-7
Product Compliance .....	1-7
Product Safety .....	1-7
Electromagnetic Compatibility (EMC) .....	1-9
<b>(2) Software Installation</b> .....	<b>2-1</b>
Contents Software Kit .....	2-1
Steps to Upgrade Software .....	2-1
<b>(3) Getting Started</b> .....	<b>3-1</b>
Instrument Overview .....	3-1
Startup .....	3-9
Instrument Settings .....	3-10
<b>(4) Setup and Testing</b> .....	<b>4-1</b>
Perform Threshold or Suprathreshold Test .....	4-1
Perform Kinetic Test .....	4-15
Create Custom Test Patterns .....	4-22
Set up Test Profiles .....	4-24
Delete Test Profiles and Patterns .....	4-24
<b>(5) Quick Reference Guide</b> .....	<b>5-1</b>
Start Up .....	5-1
Prepare for Testing .....	5-1
Preliminary Tests (Optional) .....	5-4
Perform the Test .....	5-5
Review and Save Results .....	5-6

---

<b>(6) Data, Tests &amp; Reports</b> .....	<b>6-1</b>
Save Test Reports and Test Data .....	6-1
Print Test Reports .....	6-4
Reassign Tests .....	6-4
Delete Tests .....	6-4
Import Tests .....	6-5
View and Generate Test Reports .....	6-5
Merging and Deleting Patient Records .....	6-6
Static Threshold Reports .....	6-6
Report Features .....	6-12
Suprathreshold Reports .....	6-15
Kinetic Reports .....	6-16
<b>(7) Networking</b> .....	<b>7-1</b>
Network Capabilities .....	7-1
Configuration to Pre-existing Office Network .....	7-2
Connect to a DICOM/EMR Server .....	7-3
Connect to a Printer .....	7-8
<b>(8) Maintenance</b> .....	<b>8-1</b>
Cleaning the Instrument .....	8-1
Replacing the Stimulus Projection Lamp .....	8-2
Liquid Trial Lens Care .....	8-4
Accessories and Supplies List .....	8-5
<b>(9) Data Transfer</b> .....	<b>9-1</b>
Set Up a Serial Transfer from an HFA II or HFA II-i .....	9-1
<b>(10) Data Synchronization</b> .....	<b>10-1</b>
Installation & Configuration of Data Synchronization Function .....	10-2
<b>(11) Data Backup</b> .....	<b>11-1</b>
Data Backup on Shutdown and Data Restore .....	11-1
<b>(12) Specifications</b> .....	<b>12-1</b>
HFA3 Instrument .....	12-1
<b>(A) Test Patterns &amp; Parameters</b> .....	<b>A-1</b>
Threshold Test Patterns .....	A-1
Suprathreshold Test Patterns .....	A-3
Test Parameters .....	A-8
<b>(B) Determine Trial Lens</b> .....	<b>B-1</b>

---

---

Guidelines for Trial Lens Selection . . . . .	B-1
How to Calculate the Spherical Equivalent . . . . .	B-1
<b>(C) Troubleshooting. . . . .</b>	<b>C-1</b>
Error Alerts . . . . .	C-1
Troubleshooting Table . . . . .	C-3
<b>(D) Legal Notices. . . . .</b>	<b>D-1</b>
Software Copyright . . . . .	D-1
End User Software License Agreement . . . . .	D-1



## (1) Introduction

This introductory section covers general information about the **Humphrey®** Field Analyzer 3 (HFA™3).

### Operating Principles

A patient's visual field can be assessed by briefly projecting a spot of light ("stimulus") of known size, brightness, and location on the inside surface of a roughly hemispherical bowl. Bowl illumination is controlled to establish a desired contrast between the stimulus and the area around it. Stimulus location and presentation timing are algorithmically varied to minimize the patient's ability to anticipate stimulus location and timing. Stimulus brightness is algorithmically varied to determine the dimmest stimulus that can be reliably seen at each location. The resulting visual field map is used by a trained and qualified physician as an aid in diagnosis. Historically, also known as the Humphrey Field Analyzer (HFA), this instrument is the gold standard of perimetry worldwide.

In addition to static perimetry, the HFA3 allows you to perform kinetic perimetry that emulates manual standard Goldmann perimetry. You can manually select kinetic isopters, or perform custom scans automatically or step by step.

### Intended Use

The Humphrey Field Analyzer is an automatic perimeter which is intended to be used to measure the visual field of the eye.

### Indications for Use

The Humphrey Field Analyzer is an automated perimeter intended to identify visual field defects for the purposes of screening, monitoring, and assisting in the diagnosis and management of ocular diseases such as glaucoma and related neurological disorders.



Note: The HFA3 is not intended to be used as the sole diagnostic method for disease.

### Patient Population

The HFA3 may be used on all adults and children over the age of six in need of diagnostic evaluation of the eye. This includes (but is not limited to) patients with the following disabilities or challenges:

- Wheelchair user
- Very low or not measurable visual acuity
- Postural problems
- Fixation problems
- Deafness
- Large body, but not those above 99th percentile based on anthropomorphic data

There is a general requirement that the patient be able to sit upright and be able to place his or her face on the chin and forehead rest of the instrument (with or without supplemental human or mechanical support).

### Part of the Body

The HFA3 physically interacts with the patient's forehead and chin. The patient's hand and fingers (or similar ability) are also required to press the patient response button.

**Application**

The HFA3 is designed for continuous use, although it is expected that most sites operate the instrument for 10 hours or less per day, indoors, within a medical office or hospital setting. This setting should have clean air free of soot, vapors from adhesives, grease, or volatile organic chemicals. Other Operating Environment specifications are given in [Chapter \(12\), "Specifications"](#). Application related warnings are given in this chapter and elsewhere throughout the manual.

**User Profile**

We assume that users are clinicians with professional training or experience in the use of ophthalmic equipment, and in diagnostic interpretation of the test results. Specific assumptions regarding the profiles of individuals performing instrument operation or data interpretation are given below. This manual contains information that will aid in the proper instrument operation and interpretation of the resultant data.

**Instrument Operation****Demographic**

The user should be an adult, and at least one of the following:

- Ophthalmologist
- Optometrist
- Nurse
- Certified Medical Technician
- Ophthalmic Photographer
- Non-certified Assistant

**Occupational Skills (Frequently used functions)**

The user should have appropriate training in order to perform all of the following tasks:

- Power on the instrument
- Enter, find, and modify patient identifying data
- Clean surfaces that contact patient
- Position patient with the instrument, including moving the patient, the instrument, the table height, and the patient's chair
- Select and initiate a test
- Review and save a test or try again
- Generate an analysis report
- Review the analysis report for completeness
- Save, print, or export an analysis report
- Archive data
- Power off the instrument

**Data Interpretation****Demographic**

The user should be one of the following:

- Ophthalmologist or other Medical Doctor
- Optometrist or equivalent



### Occupational Skills

The user should have the following skills:

- See [Instrument Operation](#) on page 1-2.
- Ability to work with elderly patients and those with disabilities

### Job Requirements

The user should have training and certification in the analysis and treatment of ophthalmic diseases or other eye-related medical issues as required by governing bodies.

### Purpose of This User Manual

The HFA3 Instructions for Use instructs the user in the procedures for operating the instrument, testing the patient, and reviewing and printing test reports. The screens presented by the instrument are designed to be intuitive.



Note: Trademarked terms, terms related to DICOM usage, and some networking terms are not translated from English on the user interface and in the instructions for use.

### Models

This guide contains instructions for Models 830, 840, 850, and 860. Licensed software and various hardware upgrades differentiate models. See [Model Features](#) on page 3-5.

### Text Conventions

The terms “select,” “choose,” “touch,” “press,” and “tap” each mean to initiate an operator action using the touch screen, external keyboard, or mouse.

This manual means “left-click” when it says “click,” except where “right-click” is specified.

### Electronic User Manual Access

The HFA3 User Manual, created in Acrobat PDF format for use on a computer, is provided on the HFA3 User Documentation USB included in the instrument accessory kit. If necessary, go to [www.adobe.com](http://www.adobe.com) to download and install the free Adobe Reader.

**Symbols and Labels**

WARNING



CAUTION



Must Follow Instructions For Use.



DisplayPort®



USB Port



Network Port



Power Switch



Type B applied parts



Patient Response Button



Headphones



Direct Current











Alternating Current



CAUTION: Hot Surface



Manufacturer

	Date of Manufacture
	Authorized European Community Representative
	Serial number
	Catalog number / part number
	Model number
	Patent
	European Conformity
	Disposal of the Product within the EU. Do not dispose via domestic waste disposal system or communal waste disposal facility.

### Safety Information

Warning: Indicates a hazardous situation which may result in death or serious injury if the appropriate safety precautions are not heeded.

Caution: Indicates a hazardous situation which may result in minor or moderate injury or damage to the device if the appropriate safety precautions are not heeded.

### Protective Packing Symbols

The protective packing symbols on the shipping carton specify the handling requirements and the transport and storage conditions for the HFA3 as it is shipped from the factory. Note these symbols in the event that the HFA3 must be stored for a period of time prior to its setup and use.

#### Handling Requirements



Fragile, Handle with Care



Keep Dry

#### Transport (Packaged)



Humidity (10% to 95%)

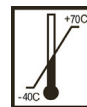

Temperature (−40 to +70 deg. C)



This end up

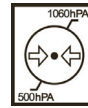

Atmospheric Pressure Limits (500 hPa to 1060 hPa)

## Instrument Disposition

When it comes time to upgrade the HFA3, please contact ZEISS to inquire about trade-in or upgrade values we may offer. Should you not wish to trade in the instrument, please see the Disposal section below.

## Disposal



**CAUTION:** This product contains electronic components. At the end of its lifetime, the product should be disposed of in accordance with the relevant national regulations.



### Disposal of the Product within the European Union (EU)

Packaging materials should be retained for future relocation or repair.

If you wish to dispose of the packaging material, contact a recognized collection system for recycling.

The device contains electronic components. At the end of its lifetime, the product and its integrated batteries should be disposed of in accordance with the relevant national regulations.

In accordance with applicable EU guidelines and national regulations at the time at which the product was brought onto the market, the product specified on the consignment note is not to be disposed of via the domestic waste disposal system or communal waste disposal facilities.

For further information on disposal of this product, please contact your local dealer or the manufacturer or its legal successor company. Please read the latest Internet information provided by the manufacturer.

Where the product or its components are resold, the seller must inform the buyer that the product is to be disposed of in accordance with the currently applicable national regulations.

## User Changes to Software or Hardware

The HFA3 is a medical device. The software and hardware have been designed in accordance with U.S., European and other international medical device standards designed to protect clinicians, users and patients from potential harm caused by mechanical, diagnostic or therapeutic failures.



**WARNING: Unauthorized modification of HFA3 software or hardware (including peripherals) can jeopardize the safety of operators and patients, the performance of the instrument, and the integrity of patient data; it also voids the instrument warranty.**

### Approved Software

Only use of software supplied or approved by ZEISS for the HFA3 is authorized. For the current list of approved software call ZEISS Customer Care: In the U.S., call 800-341-6968. Outside the U.S., contact your local ZEISS distributor.



Note: ZEISS does not provide technical support for the use of unapproved third party software.

## Instrument Installation

An authorized ZEISS service representative or the owner/operator can install the HFA3. In consultation with the buyer, ZEISS schedules one free on-site installation appointment after instrument delivery. The owner/operator receives training by Zeiss prior to using the HFA3 instrument for the first time. System installation and operator training require approximately one-half business day.

## Care in Handling

Use extreme care when handling and transporting the HFA3 shipping boxes. The instrument contains fragile optics that have been precisely aligned at the factory.

## Installation Requirements

- The HFA3 should be connected to a dedicated power outlet. The HFA3 will operate within its specifications when connected to any AC main supply in the range 90 to 264Vac, 47Hz to 63Hz.
- An isolation transformer is required when connecting peripheral devices that are not Medical Device approved (for example; printer, USB drive) within 1.5 meters (4.9 feet) away from the patient, such that the patient cannot touch a peripheral device with any part of his or her body while being examined.

## HFA3 Licenses

Each HFA3 is issued with two Windows® operating system licenses: an embedded version and a consumer version.



## Product Compliance

Complies with 93/42/EEC Medical Device Directive.

The product is RoHS-compliant according to Directive 2011/65/EU.

## Product Safety

This instrument is classified as follows:



- **Class I Equipment** – Protection against electrical shock.
- **Type B** – Degree of protection against electric shock of applied part (chin and forehead rests, and patient response button).
- **Ordinary Equipment (IPX0)** – Degree of protection against ingress of liquids (none).
- **Continuous Operation** – Mode of operation.

## General Safety Guidelines



Note: Users are not authorized to dismantle or modify the HFA3 hardware. To transport the instrument outside the office, you must consult with a ZEISS service technician. Failure to do so voids all warranties provided with the HFA3.

- **Only ZEISS authorized technicians should disassemble or service this instrument.** In the case of malfunction, error messages or operational problems, call ZEISS Customer Care: In the U.S., call 800-341-6968. Outside the U.S., contact your local ZEISS distributor.
- This instrument has no special measures to protect against harmful ingress of water or other liquids (classified IPX0—ordinary equipment). Do not place containers of liquid on or near the instrument, nor use aerosols on or near it.

- In case of emergency related to the instrument, unplug the power cord from the instrument and call for service immediately.
- The projection lamp, Trial Lens holder and Liquid Trial Lens™, patient response button, external keyboard, and fan filter are all user-replaceable parts. For the replacement of any other instrument component, accessory, or peripheral, call ZEISS Customer Care: In the U.S., call 800-341-6968. Outside the U.S., contact your local ZEISS distributor.
- Although this instrument is designed for continuous operation, it should be turned off when not in use for an extended period.
- This instrument operates according to specifications under standard indoor office (fluorescent) lighting conditions, without exposure to any direct sunlight.
- Do NOT place the cover over the instrument when the HFA3 is turned on, as loss of proper airflow can cause overheating and damage to sensitive components.
- Do NOT connect or disconnect cables while power is on.
- Do NOT place any objects on top of the instrument.
- Do NOT place any container holding liquid near the instrument.

### Warnings and Cautions



**WARNING: Do not block the ventilation openings. These allow for the release of heat generated during operation. A buildup of heat due to ventilation opening blockage can cause failures which may result in a fire hazard.**



**WARNING: To prevent electric shock, the instrument must be plugged into an earthed ground outlet. Do not remove or disable the ground pin. Only an authorized ZEISS service representative may install the instrument.**



**WARNING: Do not use the instrument or the optional power table with an extension cord or a power strip (multiple portable socket outlet). Failure to observe this warning could result in electrical shock to the patient and/or examiner.**



**WARNING: Do not open the instrument covers. Opening the instrument covers could expose you to electrical and optical hazards.**



**WARNING: If the instrument is externally connected to AC powered, non-medical peripheral devices (for example; printers, storage devices), the complete system must comply with the system requirements in standard IEC 60601-1. This standard requires the usage of an Isolation Transformer to power the non-medical peripheral device(s) if located within 1.5 m from the patient. If the peripheral device is located outside the patient environment (beyond 1.5 m) and is connected to the HFA, a separation device must be used or there shall be no electrical connection between the non-medical peripheral device and the HFA. The HFA3 Ethernet port already has the required separation integrated within the HFA3 instrument, and therefore can be directly connected to peripherals located beyond 1.5 meters.**

**The person or the responsible organization connecting additional devices or reconfiguring the system must evaluate the complete system to ensure compliance to the applicable IEC 60601-1 requirements.**

**The instrument operator must not touch the patient and the peripheral device simultaneously.**



**WARNING: Do not reconfigure system components on the table, nor add non-system devices or components to the table, nor replace original system components with substitutes not approved by ZEISS. Such actions could result in failure of the table height adjustment mechanism, instability of the table, tipping and damage to the instrument, and injury to operator and patient.**

**If the power table or any part of the system is reconfigured or replaced or if any external devices are connected to the instrument, the operator must ensure that the complete system continues to comply with the requirements defined in IEC 60601-1.**



**CAUTION:** The appliance coupler (power cord) is the main disconnect device of the instrument. Position the instrument in such a way to have easy access to disconnect the appliance coupler in case of an emergency.



**CAUTION:** In case of an emergency, disconnect the appliance coupler.



**WARNING: This instrument may cause ignition of flammable gases or vapors. Do not use in the presence of flammable anesthetics or oxidizers such as nitrous oxide or pure oxygen.**



**WARNING: Avoid tipping. Do not use the instrument on an uneven or sloped surface. Do not roll the table from one location to another while the instrument is on the table. Move the table alone to the new location and then move and place the instrument on top of the table. Failure to observe these precautions could result in tipping of the instrument and/or table and resulting injury to operator or patient and damage to the instrument.**



**CAUTION:** Make sure your USB devices are secured against malware/viruses. Patient data on USB devices can become corrupted when inserting into computers for backup or transfer. The use of anti-virus software on computers is recommended and is the responsibility of the user.

### **Electromagnetic Compatibility (EMC)**



Note: The HFA3 needs special precautions regarding EMC and needs to be installed and put into service according to the EMC information provided herein.



Note: Portable and mobile RF communications equipment can affect medical electrical equipment.



**WARNING: The use of accessories, transducers, and cables other than those specified may result in increased emissions or decreased immunity of the equipment.**



**WARNING: The HFA3 should not be used adjacent to or stacked with other equipment. If adjacent or stacked use is necessary, the equipment or system should be observed to verify normal operation in the configuration in which it will be used.**

Guidance and manufacturer's declaration - electromagnetic emissions		
The HFA3 is intended for use in the electromagnetic environment specified below. The customer or user of the HFA3 should ensure that it is used in such an environment.		
Emissions Test	Compliance	Electromagnetic environment - guidance
RF emissions CISPR 11	Group 1	The HFA3 uses RF energy only for its internal function. Therefore, its RF emissions are very low and are not likely to cause any interference in nearby electronic equipment.
RF emissions CISPR 11	Class A	The HFA3 is suitable for use in all establishments other than domestic establishments and those connected to a low voltage power supply network which supplies buildings used for domestic purposes.
Harmonic emissions IEC 61000-3-2	Class A	
Voltage fluctuations/flicker emissions IEC 61000-3-3	Complies	

Guidance and manufacturer's declaration - electromagnetic immunity			
The HFA3 is intended for use in the electromagnetic environment specified below. The customer or user of the HFA3 should ensure that it is used in such an environment			
Immunity Test	IEC 60601 test level	Compliance level	Electromagnetic environment - guidance
Electrostatic Discharge (ESD) IEC 61000-4-2	± 6 kV contact ± 8 kV air	± 6 kV contact ± 8 kV air	Floors should be wood, concrete, or ceramic tile. If floors are covered with synthetic material, the relative humidity should be at least 30%.
Electrical fast transient/burst IEC 61000-4-4	± 2 kV for power supply lines ± 1 kV for input/output lines	± 2 kV for power supply lines ± 1 kV for input/output lines	Mains power quality should be that of a typical commercial or hospital environment.
Surge IEC 61000-4-5	± 1 kV differential mode ± 2 kV common mode	± 1 kV differential mode ± 2 kV common mode	Mains power quality should be that of a typical commercial or hospital environment.
Voltage dips, short interruptions, and voltage variations on power supply input lines. IEC 61000-4-11	<5% $U_T$ (>95% dip in $U_T$ ) for 0.5 cycle 40% $U_T$ (60% dip in $U_T$ ) for 5 cycles 70% $U_T$ (30% dip in $U_T$ ) for 25 cycles <5% $U_T$ (95% dip in $U_T$ ) for 5 sec.	<5% $U_T$ (>95% dip in $U_T$ ) for 0.5 cycle 40% $U_T$ (60% dip in $U_T$ ) for 5 cycles 70% $U_T$ (30% dip in $U_T$ ) for 25 cycles <5% $U_T$ (95% dip in $U_T$ ) for 5 sec.	Mains power quality should be that of a typical commercial or hospital environment. If the user of the HFA3 requires continued operation during power mains interruptions, it is recommended that the HFA3 be powered from an uninterruptible source.
Power Frequency (50/60 Hz) magnetic field IEC 61000-4-8	3 A/m	3 A/m	Power frequency magnetic fields should be at levels characteristic of a typical location in a typical commercial or hospital environment.

Note:  $U_T$  is the a.c. mains voltage prior to application of the test level.



Guidance and manufacturer's declaration - electromagnetic immunity			
The HFA3 is intended for use in the electromagnetic environment specified below. The customer or user of the HFA3 should ensure that it is used in such an environment			
Immunity Test	IEC 60601 test level	Compliance level	Electromagnetic environment - guidance
Conducted RF IEC 61000-4-6	3 Vrms 150 kHz to 80 MHz	3 V	<p>Portable and mobile RF communications equipment should be used no closer to any part of the HFA3, including cables, than the recommended separation distance calculated from the equation applicable to the frequency of the transmitter.</p> <p><b>Recommended separation distance:</b></p> <p><math>d = 1.17\sqrt{P}</math> 150 kHz to 80 MHz</p> <p><math>d = 1.17\sqrt{P}</math> 80 MHz to 800 MHz</p> <p><math>d = 2.33\sqrt{P}</math> 800 MHz to 2,5 GHz</p>
Radiated RF IEC 61000-4-3	3 V/m 80 MHz to 2,5 GHz	3 V/m	<p>Recommended separation distance where P is the maximum output power rating of the transmitter in watts (W) according to the transmitter manufacturer and d is the recommended separation distance in meters (m).</p> <p>Field strengths from fixed RF transmitters, as determined by an electromagnetic site survey,<sup>a</sup> should be less than the compliance level in each frequency range.<sup>b</sup></p> <p>Interference may occur in the vicinity of equipment marked with the following symbol:</p> 
<p>Note 1: At 80 MHz and 800 MHz, the higher frequency applies.</p> <p>Note 2: These guidelines may not apply in all situations. Electromagnetic propagation is affected by absorption and reflection from structures, objects and people.</p>			
<p><sup>a</sup> Field strengths from fixed transmitters, such as base stations for radio (cellular/cordless) telephones and land mobile radios, amateur radio, AM and FM broadcast, cannot be predicted theoretically with accuracy. To assess the electromagnetic environment due to fixed RF transmitters, an electromagnetic site survey should be considered. If the measured field strength in the location in which the HFA3 is used exceeds the applicable RF compliance level above, the HFA3 should be observed to verify normal operation. If abnormal performance is observed, additional measures may be necessary, such as reorienting or relocating the HFA3.</p> <p><sup>b</sup> Over the frequency range 150 kHz to 80 MHz, field strengths should be less than 3 V/m.</p>			

Recommended separation distances between portable and mobile RF communications equipment and the HFA3			
The HFA3 is intended for use in an electromagnetic environment in which radiated RF disturbances are controlled. The customer or the user of the HFA3 can help prevent electromagnetic interference by maintaining a minimum distance between portable and mobile RF communications equipment (transmitters) and the HFA3 as recommended below, according to the maximum output power of the communications equipment.			
Rated maximum output power of transmitter W	Separation distance according to frequency of transmitter m		
	150 kHz to 80 MHz	80 MHz to 800 MHz	800 MHz to 2,5 GHz
	$d = 1.17 \sqrt{P}$	$d = 1.17 \sqrt{P}$	$d = 2.33 \sqrt{P}$
0,01	0.117	0.117	0.233
0,1	0.370	0.370	0.737
1	1.170	1.170	2.330
10	3.700	3.700	7.368
100	11.700	11.700	23.300
For transmitters rated at a maximum output power not listed above, the recommended separation distance d in meters (m) can be estimated using the equation applicable to the frequency of the transmitter, where P is the maximum output power rating of the transmitter in watts (W) according to the transmitter manufacturer.			
Note 1: At 80 MHz and 800 MHz, the higher frequency applies.			
Note 2: These guidelines may not apply in all situations. Electromagnetic propagation is affected by absorption and reflection from structures, objects and people.			

### Risks of Internet Connectivity



**CAUTION:** When connected to the Internet, the HFA3 instrument may be vulnerable to serious security risks, including viruses and worms that could disable your system or adversely affect its performance. Internet connectivity enables third party software drivers and updates to be downloaded to your system, either automatically or intentionally. Installation of any unapproved software, including drivers, could degrade the performance of the instrument and/or lead to corrupted diagnostics or therapeutic information and may void the instrument warranty.

## (2) Software Installation

This section covers the installation instructions for the **Humphrey®** Field Analyzer 3 (HFA™3).

### Contents Software Kit

The software kit contains two USB drives:

- The white USB drive with the “SW” label contains the software update and is used for loading the software onto the HFA3.
- The blue USB drive with the “UD” label is the user documentation, including the installation instructions and the Instructions for Use. This content is for your reference and is not required for software installation.

### Steps to Upgrade Software

For all existing versions of HFA3 software, start with the following steps to upgrade the software:

1. Start the instrument and log in as a user with Administrator privileges.



2. Select the **Settings** icon  located in the **Toolbar** at the top of the screen. The **Settings** screen will appear.



3. Record the software version number you are currently running.

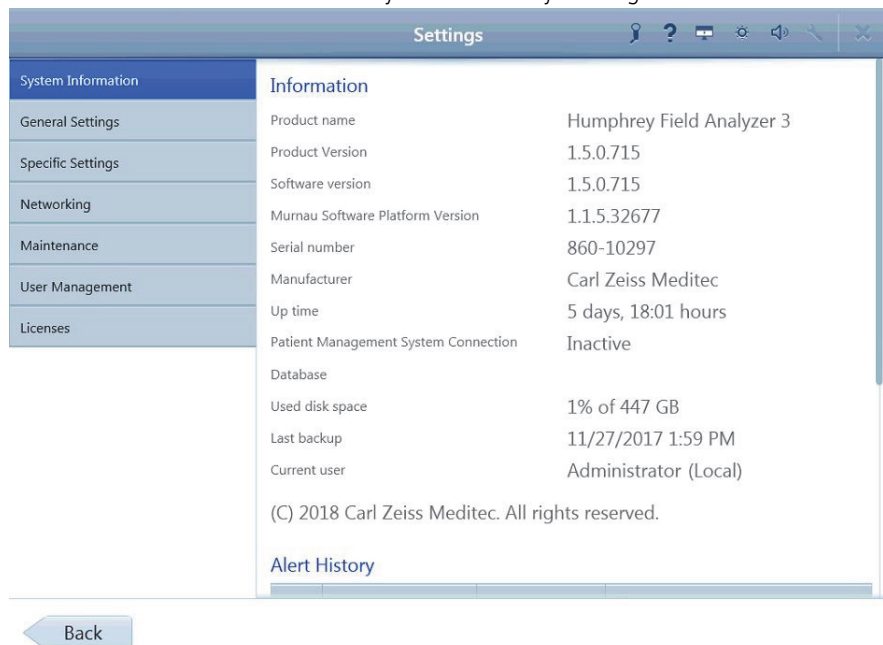

4. Insert the white USB drive with the **SW** label, which contains the software update, in one of the HFA3 USB connections.

**Note:** If you get an error message during installation, please take a screenshot (Print Screen and save in a graphics application, such as Microsoft Paint) of the information, then call your local ZEISS customer service number, shown on the back of this manual.

5. Navigate to the **Maintenance** screen and select **Perform update...** A confirmation screen will appear. Select **Yes** to start.

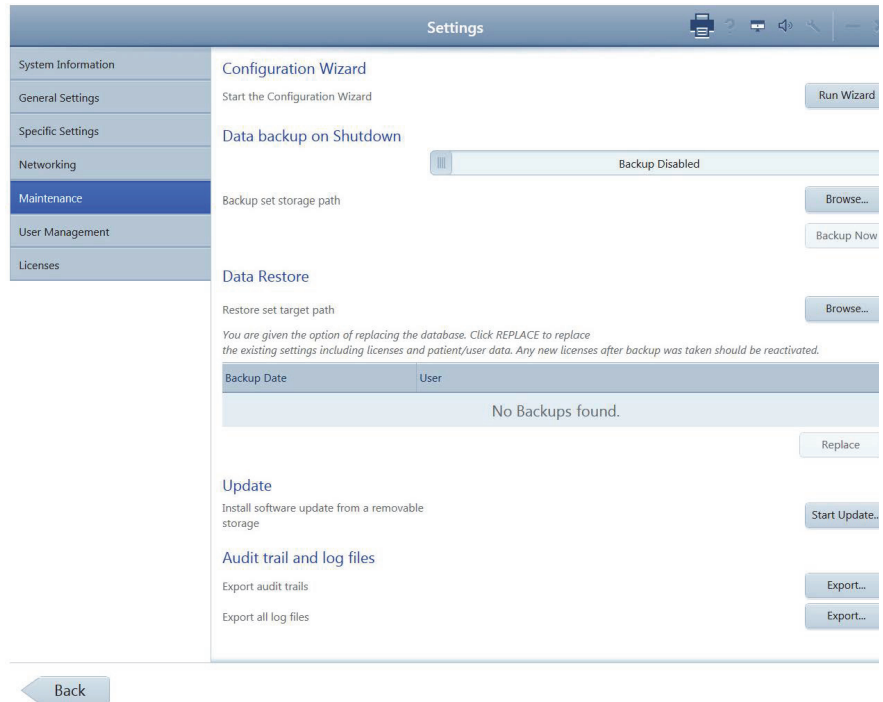

6. Select **Yes** to start the Update Wizard.

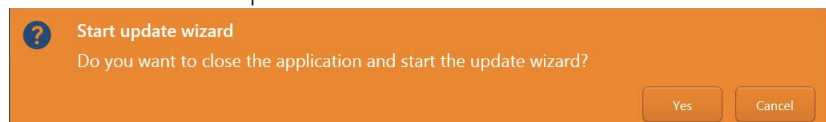

7. A popup screen appears with the update. Highlight the update and select **Run**.



Run

Close



CAUTION: From this point forward, please do not click on, or touch, the screen anywhere other than as instructed. Otherwise, you risk aborting installation progress.

8. Follow the on-screen instructions through the rest of the software upgrade process.

**Note:**

- There may be brief sequences when the screen goes black for several seconds. Wait for the next on-screen prompt.
- Do not touch the screen or type on the keyboard during the installation process except as directed by the on-screen prompts.
- There may be screens that show a progress bar. Occasionally, the progress bar will stop for several seconds, but the installation is still in progress.
- There will be several prompts for going to the next step or confirming a step. Respond to these prompts by using the touchscreen or the cursor driven by the keyboard or external mouse.

9. Select **Finish** from the **InstallShield Wizard Complete** screen.

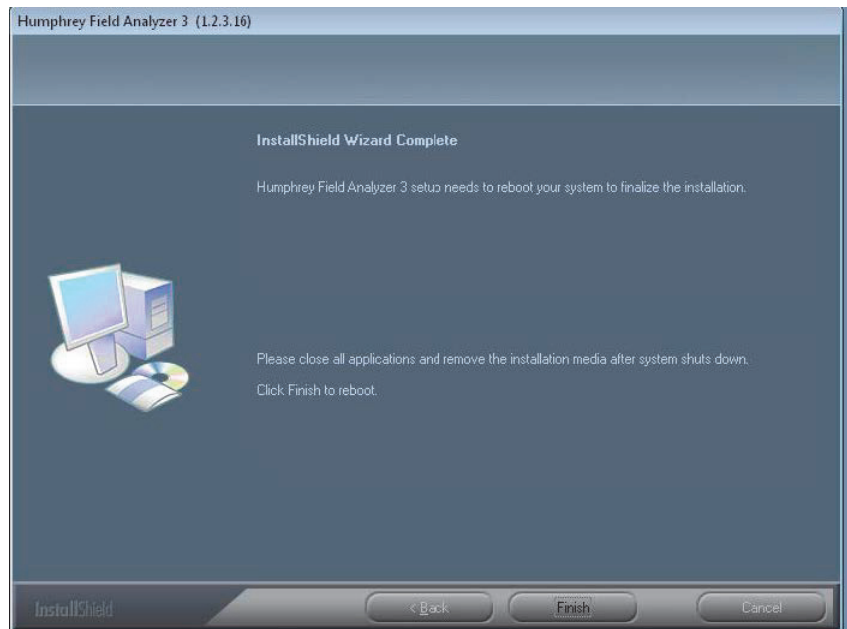

10. The background screen turns black. A message appears: **You are about to be logged off. Please start the instrument after shutdown.**

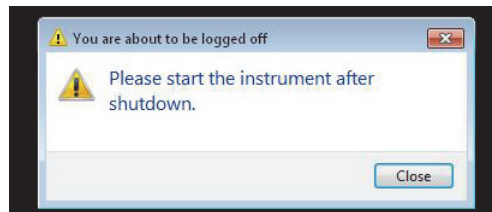

11. Click **Close** and wait for the instrument to shutdown.

12. Restart depending on the version:

- If you are upgrading from version 1.3.x.x or older- Turn the instrument ON by pressing the **Power** button.

- If you are upgrading from version 1.4.1.x - Installer signals the controller to restart itself.
13. The instrument boots up and the screen may be black for several minutes. Wait until the **InstallShield Wizard** screen appears again. Allow the installer to complete the software update.
  14. The **InstallShield Wizard Complete** screen appears. Click **Finish** to exit to the Wizard.

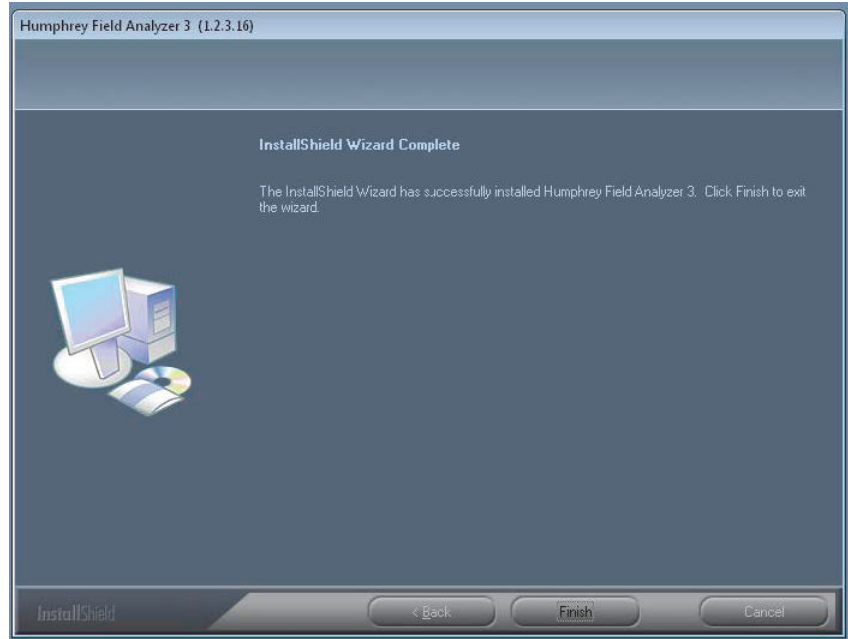

15. Remove the USB drive from the HFA3 instrument. You may now safely run the updated HFA3 software.

### (3) Getting Started

This chapter describes instrument features, general operation, and settings of the HFA3.

#### Instrument Overview

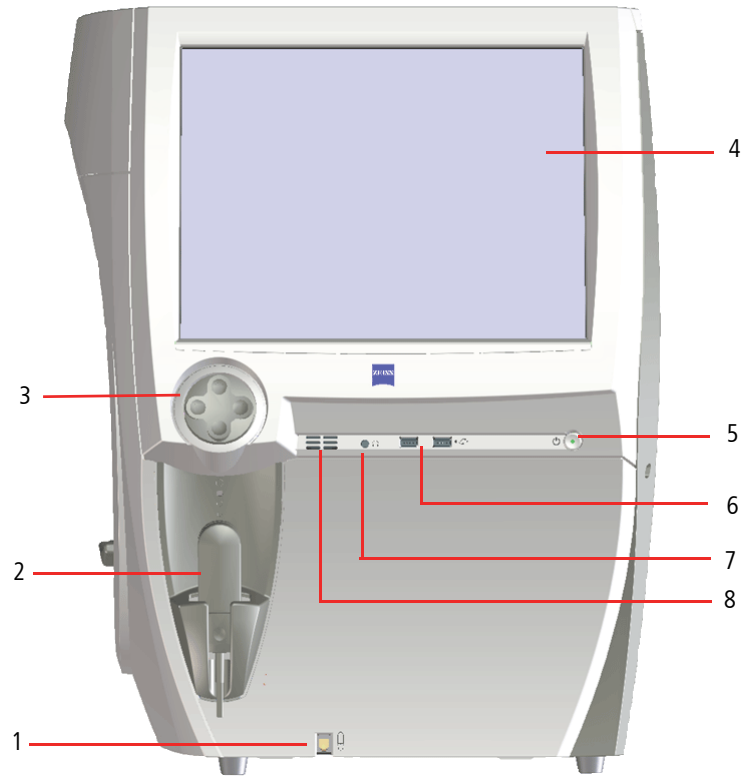
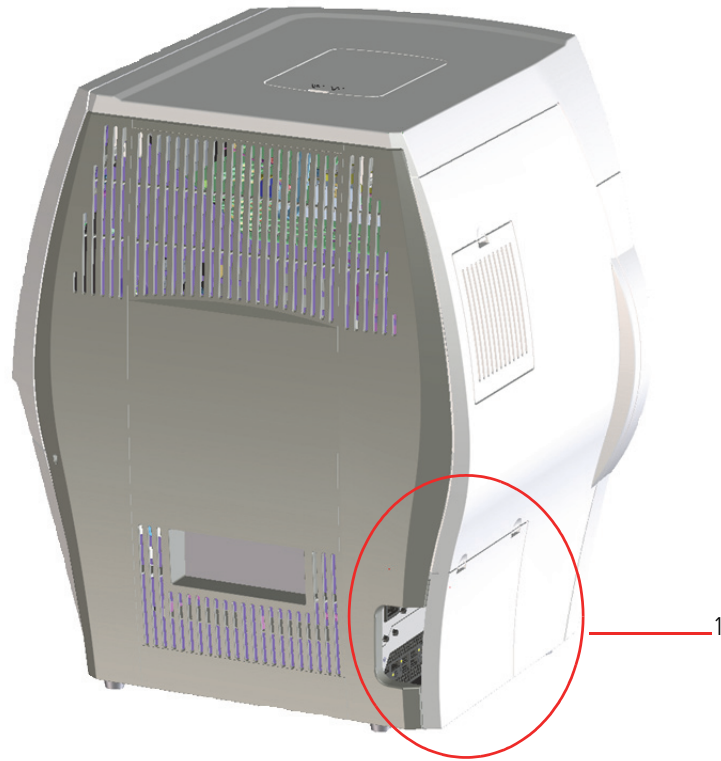

Figure 3-1 The HFA3— Operator View

- |  |                         |                  |
|--|-------------------------|------------------|
| 1 – Patient response button connection | 4 – Touch screen        | 7 – Audio output |
| 2 – Patient response button            | 5 – On/Off button       | 8 – Speaker      |
| 3 – Chin rest control                  | 6 – USB connections (2) |                  |



*Figure 3-2 The HFA3—Side Panel Closed*

1 – Location Side Panel



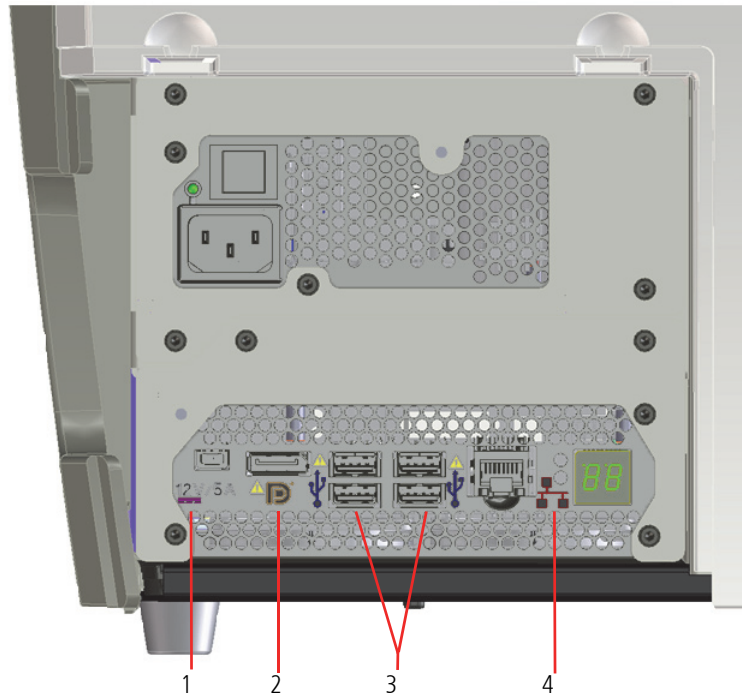
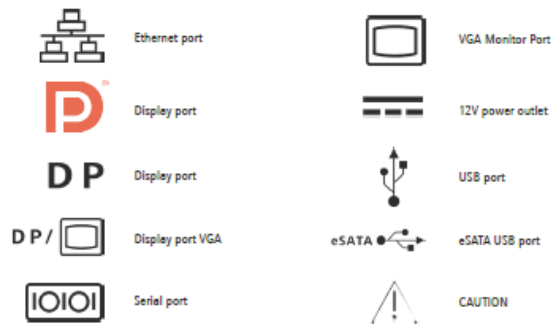

Figure 3-3 The HFA3– Side Panel Opened

- 1 – 12V Power Outlet
- 2 – Display Port
- 3 – USB Port
- 4 – Ethernet Port

**• OPERATION UPDATES**

The back panel configuration may be different than what appears in the Instruction for Use. Please refer to the symbols shown below for clarification of connectivity.



**• SPECIFICATION UPDATES**

**Computer**

- Serial and USB Port Configuration**
- Operating System: Windows 7– 64 bit
  - Intel® Core i3-4350T
  - Internal storage: 500 GB
  - 6 external USB ports, Type A (2 USB 2.0 and 4 USB 3.0)
  - Ethernet Port (GbE)
  - DisplayPort video output
  - USB Keyboard & Mouse
  - LCD Display with integrated touch screen

- USB Port Configuration**
- Operating System: Windows 7– 64 bit
  - Intel® Core i7-610E
  - Internal storage: 500 GB
  - 6 external USB ports, Type A, USB 2.0 specification
  - Ethernet Port (4KV isolated GbE)
  - DisplayPort video output
  - 12V power outlet
  - USB Keyboard & Mouse

Figure 3-4 Back Panel Symbols

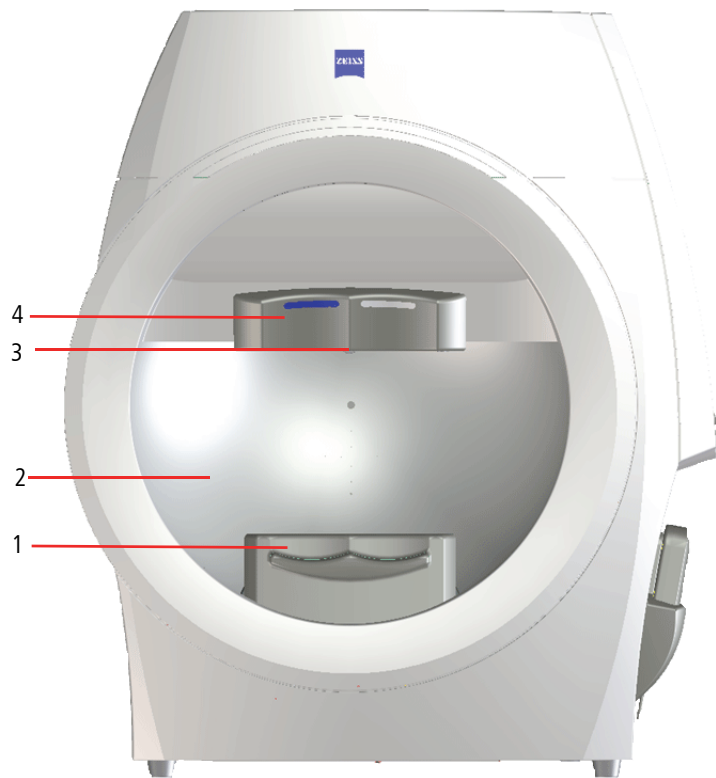

*Figure 3-5 The HFA3 – Front View*

1 – Chin rest

2 – Testing bowl

3 – Visor handle

4 – Forehead rest

**Model Features**

For a full list of available test patterns and strategies see [Appendix \(A\), "Test Patterns & Parameters"](#).

Feature	Model			
	830	840	850	860
Manual Kinetic	No	License <sup>a</sup>	Standard	Standard
Custom Kinetic Patterns	No	License <sup>a</sup>	Standard	Standard
Custom Static Patterns	No	Standard	Standard	Standard
DICOM OPV (Ophthalmic Visual Field) IOD (Information Object Definition)	Standard	Standard	Standard	Standard
OPV IOD Advanced Indices <sup>b</sup>	License	License	License	License
Remote Diagnostics and Software Loading	Standard	Standard	Standard	Standard
SITA™, STATPAC™	Standard	Standard	Standard	Standard
SITA-SWAP™	No	No	Standard	Standard
Stimulus Size	I–V	I–V	I–V	I–V
Auto Pupil Measurement	No	Standard	Standard	Standard
Stimulus Color	White	White, Red	White, Blue, Red	White, Blue, Red
Foveal Threshold	No	Standard	Standard	Standard
Gaze Tracking	No	Standard	Standard	Standard
Head Tracking	No	Standard	Standard	Standard
Vertex Monitor	No	No	Standard	Standard
GPA™	Standard	Standard	Standard	Standard
Liquid Trial Lens	No	No	No	Standard
RelEYE™ Monitor	No	No	Standard	Standard

a. Available by license only in the U.S., but standard in the rest of the world.

b. Available without license in Germany, Austria, Switzerland, and Japan.

**External Keyboard**

The HFA3 comes with a standard external keyboard and trackpad combination. Plug input devices into USB ports located on the operator and opposite sides of the instrument.

**USB Devices**

Use only NTFS formatted USB storage devices for backup.



**CAUTION:** Make sure your USB devices are secured against malware/viruses. Patient data on USB devices can become corrupted when inserting into computers for backup or transfer. The use of anti-virus software on computers is recommended and is the responsibility of the user.

### Surge Protectors

ZEISS recommends the use of surge protectors or UPS (Uninterruptible Power Supply) systems to help isolate the HFA3 from power surges or fluctuations. Hospitals, surgery centers, and offices with instruments which consume large amounts of power, such as surgical lasers, especially should be careful to plug the HFA3 directly into a UPS or adequate surge protector.

### Printers

The HFA3 is compatible with PostScript printers, including shared network printers and wireless printers using a wireless USB adapter, or directly connected using the Ethernet port. Direct USB connection is not supported.



**WARNING: If any external devices are connected to the instrument, the operator must ensure that the complete system continues to comply with the requirements defined in IEC 60601-1.**

### Touch Screen

All functions can be performed by touching a command button on the touch screen. Be careful not to press too hard against the screen. To deselect an item, touch on another area of the screen. To return to a previous screen, if applicable, select the **Back** button on the lower left side.

### Screen Keyboard

The screen keyboard is used to fill out the text boxes. It appears automatically as soon as the cursor is inserted into a text box. Touch and hold a character to bring up a menu with all the special characters (umlauts, etc.) belonging to this character. Select the desired special character by tapping it. Not all characters on the keyboard will be associated with special characters.

Keyboard icons:



Switches the keyboard layout from letters to numerals and special characters.



Switches the keyboard layout from numerals and special characters to letters.



Hides the screen keyboard.



Select a flag to switch the language of the keyboard.



Note: The right click key available on some external keyboards will enable or disable the screen keyboard, overriding the instrument setting. Moving the keyboard slider back and forth or pressing the right click key again on the external keyboard will reverse the effect.

### Access Menu Options

To access the options offered through each screen, touch or click on an option to select it. Touch or click on menu options again to make the options disappear.

The screenshot shows the HFA3 software interface. At the top, there is a navigation bar with 'Patient > Test > Results'. Below this is a search bar for 'Patient Name, ID, DOB' and a list of patients. The selected patient is 'Patient 1, HFA3' (ID: 1629690193, DOB: 12/9/1963, 54 years old). The main area displays test configuration options for 'Central 24-2, SITA Faster'. The 'Distance Prescription' table is as follows:

	Sphere	Cylinder	Axis
Distance Prescription OD	+3.00	+3.00	33
Distance Prescription OS	-4.00	-4.00	44

The 'Trial Lens' table is also shown:

	Sphere	Cylinder	Axis
Trial Lens OD	+5.50	+3.00	33
Trial Lens OS	-0.75	-4.00	44

Other configuration options include 'Perform test on' (Both), 'Start with' (OD), 'Test Parameters' (Central 24-2, SITA Faster), 'Reports' (SFA), 'IOP' (OD/OS), 'Pupil Diameter' (OD/OS), and 'Visual Acuity' (OD/OS). At the bottom, there are buttons for 'Reports', 'Tests', and 'Next'.

- Some menus are fields tagged with a down arrow (drop-down lists). To access menu options, touch or click on the bar. Select the bar again to close the menu.

24-2, SITA Faster

- Grayed-out menu options or buttons are not available.

### Using the External Keyboard and Mouse

You may also use the external keyboard to move from one selection to the next on the HFA3 screen and enter data.

Select the intended data field with the touch screen or a mouse:

- Use the **Tab** key to move the highlight from one data field to another in a forward direction.
- Hold the **Shift** key down while pressing the **Tab** key to move in the opposite direction.
- Arrow keys may be used to move the cursor within a data field.



Note: Selecting **Ctrl + Alt + Delete** on your keyboard will take you to the Windows lock screen. Select **Cancel**, or press the **Esc** button on the keyboard to return to the instrument screen. If you log off in this screen, restart the instrument.

**Title Bar**

Title bar icons:



This icon appears if the Liquid Trial Lens is installed (Model 860 only) and flashes red during lens adjustment. Do not touch the Liquid Trial Lens when the icon is blinking.



Select the **Private** button to hide the screen from anyone who does not need to view patient data. Click the **Continue** button to return to the patient data.



Tap the **Help** button to open the on-screen user manual.



The **Brightness** button displays a control for adjusting the brightness.



Tap the **Volume** button to display a slide control for adjusting the volume.



The **Settings** button opens the Settings dialog window. See "[Instrument Settings](#)," on [page 3-10](#).

When there is a new alert, an exclamation point appears with the **Settings** button. Clicking on the exclamation point opens the **Message** history.



The **Close** button opens a menu with options for logging out the current user or switching off the device.

## Startup

Upon first startup, the instrument will prompt the user to configure or use default settings for Locale, Network setup, User Management configurations, and Users. For details see “[Instrument Settings](#),” on page 3-10). Leave the field blank or use **0000 (zero’s)** when asked for the default password.



**CAUTION:** To protect patient data change the password. We recommend setting the password strength to HIGH.

1. Switch the instrument on by pressing the On/Off button, located on the operator side of the instrument under the display.
2. Wait five minutes to allow the instrument to perform a self-diagnostic checkup. If the internal computer detects a problem, a message will appear on the startup screen.
3. Select **Continue** to proceed or **Details** to view any error messages.
4. Log in by selecting the appropriate user from the drop-down menu and entering the password.



Note: The Emergency login allows a person who does not have access privileges to log in and use the instrument. Emergency logins are audited and usage of the instrument is restricted. Emergency login users cannot view or perform exams on existing patients.

If there is a question as to whether the HFA3 is running properly or if there is any question about electrical or fire safety: **TURN OFF AND UNPLUG THE INSTRUMENT** and call ZEISS customer care as soon as possible: 1-800-341-6968. Outside the U.S., contact your local ZEISS distributor.

## Operating Environment

For optimal testing results, the HFA3 should be operated in a dimly lit room with minimal distractions. The patient should be in a comfortable position throughout testing.

## Operating Modes

The HFA3 has three modes of operation:

Mode	Description
Local database	Patient records are stored directly on the instrument. All functions, including editing patient data and generating reports, can be done on the instrument.
Connected - FORUM	Data is automatically exported to the FORUM archive and deleted on the instrument.
Connected - DICOM Non-DICOM EMR	Data is automatically exported to a DICOM archive, shared network folder, or FTP folder.





## Instrument Settings

Select the **Settings** icon to display the setting types. Select and enter data or choose parameters as needed in each type of setting. When changes are made that require a reboot, a restart symbol  appears on the **Back** button. The device restarts automatically when you select the **Back** button.

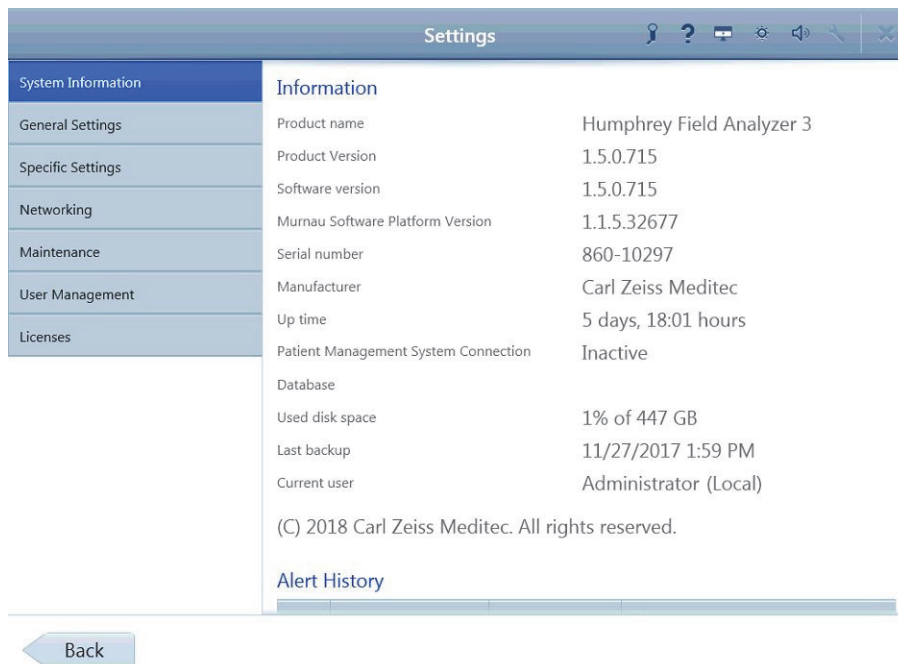
## System Information

The **System Information** screen displays information about the software, instrument, and connections.



Setting Option	Description	
Information	Showing system information.	
Alert History	<b>List of alert history</b> , sorted per Date, User and Title. Shows issues and important actions. System messages are marked with the following symbols:	
	Information	
	Warning	
	Error	
	Serious Error	
	<b>Clear:</b> Clears the complete list.	
Back	Go back to the previous screen.	



### General Settings

Use the **General Settings** screen to configure general settings, such as date and time format, patient identification format, and printing options.

**Settings**

Please note: settings with this sign require a restart to become active!

**Institution Information**

Institution name:

Department:

Address line 1:

Address line 2:

Phone number:

E-mail:

Web:

**Application**

Alert display time:  seconds

**Locale Settings**

Language:

Format:

Short date format:

Long date format:

Short time format:

Long time format:

**System Date and Time**

Time zone:

Current date:

Current time:

**Carl Zeiss Meditec Teleservice**

Create a package with service relevant data for the service.

Start a remote control session with a service technician.

**Carl Zeiss Meditec Remote Service**

Create a Diagnostic Package.

Start Screen Recording.

Stop Screen Recording.

Resume/Suspend Diagnostic Client Software.

**On-Screen Keyboard**

Use on-screen keyboard:

**Patient Management**

Patient identification:

Please note: The patient will be identified by personal data (name etc.) and an ID.

Patient ID issuer:

Auto-generate patient ID:

**Multi Component Names**

Multi component names:

**Printer and Report**

Signature field on reports:

Report logo:

Report storage path:

Setting Option	Description
Institution information	Enter information about your clinic, which is printed at the top of reports.
Application	<b>Alert display time:</b> Set amount of seconds for alert display time.
Locale Settings	Sets the user interface language, format and the date and time formats.
System Date and Time	Sets the time zone, current date and current time.
Carl ZEISS Meditec Teleservice	Toggle offline and online Teleservice. Create a package with service relevant data for the service. Start a remote control session with a service technician.
Carl ZEISS Meditec Remote Service	Create a Diagnostic Package. Start Screen Recording. Stop Screen Recording. Resume/Suspend Diagnostic Client Software.
On-screen Keyboard	Enables or disables the on-screen keyboard.
Patient Management	<b>Patient identification:</b> Sets whether patients are identified by name and ID or by ID only. <b>Patient ID issuer:</b> Identifies where the patient ID originates from. <b>Auto-generate patient ID:</b> When this option is enabled, the HFA3 automatically issues patient IDs for new patients.
Multi Component Names	Toggle <b>Enabled/Disabled</b> patient names to be displayed using the Latin alphabet, ideographic characters, or a phonetic rendering.
Printer and Report	<b>Signature field on reports:</b> Show or hide. Sets whether a blank space is included on reports for signatures. <b>Report logo:</b> Click <b>Browse</b> to select an image file of your clinic's logo to include on reports. <b>Report storage path:</b> Click <b>Browse</b> to select a network location or USB drive where reports are exported. Click on <b>Manage Printers...</b> to view the list of installed printers; add, edit, or delete a printer; set a printer as default or change its settings; or print a test page. See " <a href="#">Connect to a Printer,</a> " on page 7-8 for more information about adding printers.
Back	Go back to the previous screen.

## Specific Settings

Use the **Specific Settings** screen to manage test profiles and custom test patterns, import and transfer data, configure reports and instrument settings, and manage EMR settings.

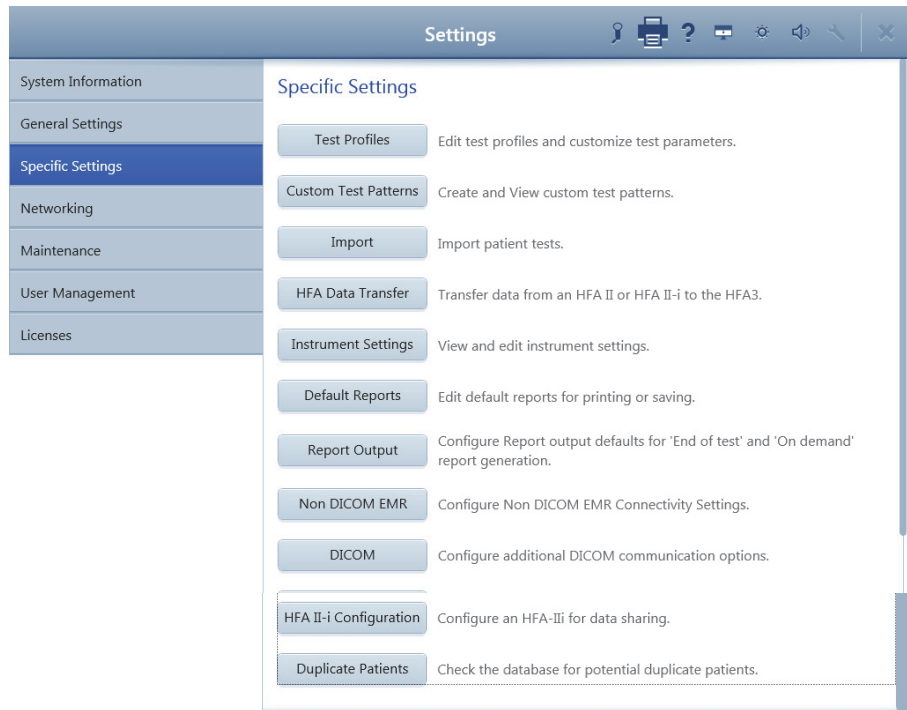

Back

Button	Function
<b>Specific Settings</b>	Select the default test and create new test profiles.
Test Profiles	Edit test profiles and customize test parameters. See <a href="#">"Set up Test Profiles,"</a> on page 4-24 and <a href="#">"Test Patterns &amp; Parameters,"</a> on page A-1
Custom Test Patterns	Create and view custom Static and Kinetic Test Patterns. See <a href="#">"Create Custom Test Patterns,"</a> on page 4-22. (Not available for Model 830)
Import	Import patient tests from a shared network folder or USB storage device. See <a href="#">"Import Tests,"</a> on page 6-5.
HFA Data Transfer	Transfer patient data from an HFA II or HFA II-i to the HFA3 instrument database. See <a href="#">"Data Transfer,"</a> on page 9-1.
Instrument Settings	Adjust instrument settings. See <a href="#">"Instrument Settings,"</a> on page 3-10.
Default Reports	Choose the default report types for manually printing and exporting reports. See <a href="#">"View and Generate Test Reports,"</a> on page 6-5.
Report Output	Select to configure the format and destination for automatic and manually generated reports. See <a href="#">"Report Output,"</a> on page 3-18.
Non DICOM EMR	Configure non-DICOM EMR connectivity settings. See <a href="#">"Connect to a Non-DICOM EMR,"</a> on page 7-5. To use the instrument in local database mode, turn off <b>EMR Mode</b> .

Button	Function
DICOM	Configure additional DICOM communication options. See <a href="#">“Networking,” on page 7-1</a> for further details.
HFA II-i Configuration	Configure an HFA II-i for data sharing. See <a href="#">“Data Synchronization,” on page 10-1</a> for further details.
Duplicate Patients	Check the database for potential duplicate patients. See <a href="#">Potential Duplicate Patients</a> for more information.
Back	Go back to the previous screen.

### Potential Duplicate Patients



Note: Patient records are evaluated using the following rules and actions to determine potential duplicate patients after Data Synchronization, HFA3 import, or import from an HFAII-i.

A **flagged** patient record will show an exclamation point next to the patient record in the patient selection list. When you select the patient record, you must choose whether to merge the patient with the suspected duplicate or maintain the two patients as separate records before proceeding.

**Separate Patients** means that the patient records are not flagged and remain as independent records

Potential duplicate patients are resolved as follows:

Patient ID	Issuer of ID	Name/Date of Birth	Action
Match	Match	Match	Merge
Match	Match	Different	Flagged
Match	Different	Match	Separate Patients
Match	Different	Different	Separate Patients
Different	Match	Match	Separate Patients
Different	Match	Different	Separate Patients
Different	Different	Match	Separate Patients
Different	Different	Different	Separate Patients

See [“Select Patient,” on page 4-1](#) and the **Note** at [“Patient Search,” on page 4-1](#) for more information about resolving potential duplicates.

To restore the database:

1. Select the backup from the list under Restoring data.
2. Select Replace.
3. Confirm your selection.
4. When the restore operation is complete, a confirmation displays. Select Restart to restart the instrument.

## Instrument Settings

Instrument Settings

Eye Image Brightness

Sounds

Start of Test  On Successful Event  On

Alert / Warning  On Patient Switch  On

Simulation Mode  On

Eye Laterality Default Position

Visual Acuity Format

Back Revert to Default

Settings Option	Description
Instrument Settings	Manipulate the default settings for the instrument.
Eye Image Brightness	Move the slider to the right to increase eye image brightness or to the left to decrease brightness. Note that changing the default settings may affect Gaze Tracking.
Sounds	<b>Start of Test:</b> Toggle an audible signal On/Off at the beginning of test. <b>Successful Event:</b> Toggle signal On/Off for a successful event. <b>Alert/Warning:</b> Toggle signal On/Off for an alert or warning. <b>Patient Switch:</b> Toggle signal On/Off for response button press.
Simulation Mode	Toggle simulation mode On/Off. Simulation mode must be off to run a test.
Eye Laterality Default Position	Sets the default for which eye is tested first.
Visual Acuity Format	Sets the format for entering a patient's visual acuity as Snellen (20/20), Metric (6/6), or Decimal (1.0)
Revert to Default	Click on <b>Revert to Default</b> to reset to default values.
Back	Go back to the previous screen.

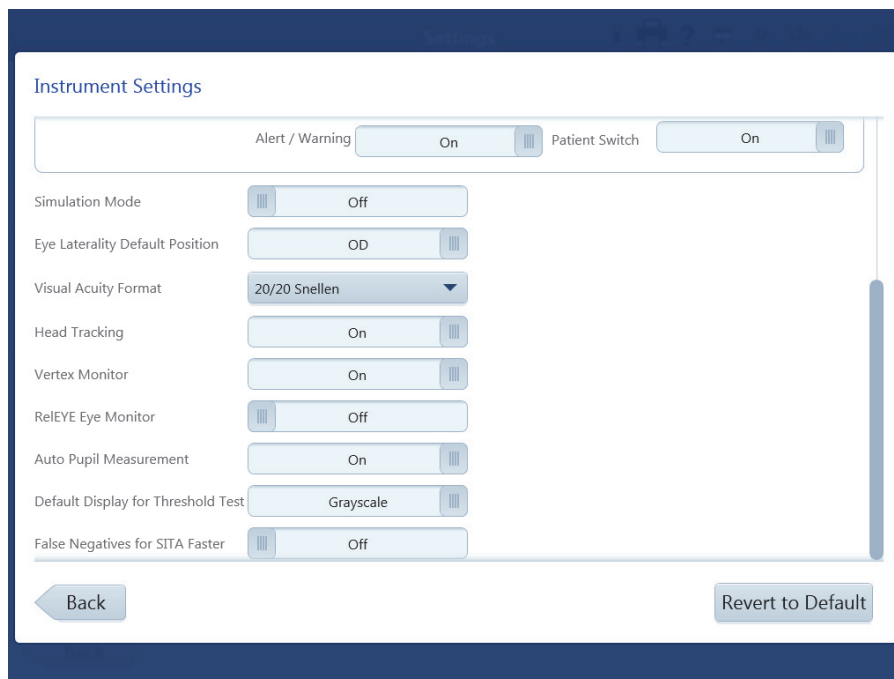

Settings Option	Description
Head Tracking (Not in Model 830)	Enables the Head Tracking function, which aids in keeping the patient's eye centered behind the trial lens. The trial lens holder must be up and Gaze Initialization must be successful for this feature to work.
Vertex Monitor (Only in Model 850 and 860)	Enables the Vertex Monitoring feature, which aids in keeping the patient's eye centered behind the trial lens. The trial lens holder must be up and Gaze Initialization must be successful for this feature to work.
ReIYE Eye Monitor (Only in Model 850 and 860)	Enables the ReIYE feature, which records an image of the eye each time a stimulus is presented during a Threshold SITA-Standard, Suprathreshold Central 76, or Esterman Monocular test.
Auto Pupil Measurement (Not in Model 830)	Enables automatic pupil diameter measurement, which is indicated on reports with an asterisk. Gaze initialization must be successful for this feature to work.
Default Display for Threshold Test	Sets the default display during Threshold testing to either grayscale or numerical.
False Negatives for SITA Faster	Toggle On/Off.
Revert to Default	Click on <b>Revert to Default</b> to reset to default values.
Back	Go back to the previous screen.

### Default Reports

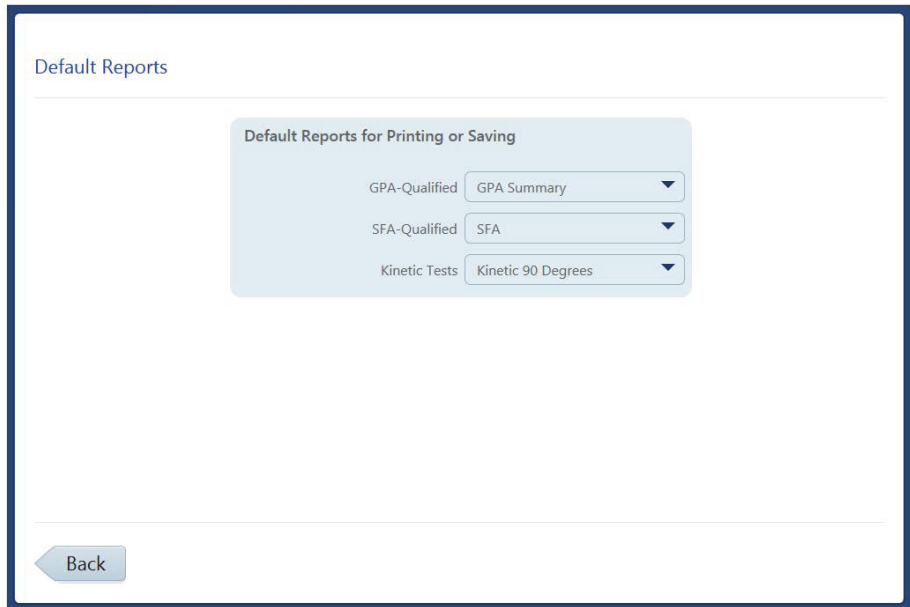

Settings Option	Description
Default Reports	Under <b>Default Reports for Printing or Saving</b> set the desired GPA-Qualified, SFA-Qualified and the Kinetic Tests.
Back	Go back to the previous screen.

## Report Output

## End of Test Settings

DICOM Output

FORUM Test Database  Off

Export EPDF  Off

Report Output

Report Output Default

Report Export File Type

Report Export Location  ...

Named Patient Folder  Off

Patient ID in folder name  Off

Back

Settings Option	Description
End of Test Settings	Configure settings for export to DICOM and report output settings.
DICOM Output	Toggle On/Off for <b>FORUM Test Database</b> and for <b>Export EPDF</b> . See <a href="#">Chapter (7), "Networking"</a> for further details.
Report Output	<p>Sets the default action to be taken with automatically generated reports.</p> <p><b>Report Output Default:</b> Use drop-down menu to choose output default.</p> <p><b>Report Export File Type:</b> Set the default format for reports that are exported. Note that DICOM OPV format is supported only for SFA, Three In One, Suprathreshold, and Numeric reports.</p> <p><b>Report Export Location:</b> Click on the triple dot button <input type="text" value="..."/> to set the default destination. Browse to the location where reports have to be exported to.</p> <p><b>Named Patient Folder:</b> Toggle On/Off to set whether a folder with the patient's name is created for a report that's exported.</p> <p><b>Patient ID in folder name:</b> If <b>Named Patient Folder</b> is enabled, determine whether the patient ID is also included in the folder name by using toggle On/Off.</p>
Back	Go back to the previous screen.



## Networking

Use the **Networking Settings** screen to configure network connections. See [Chapter \(7\), "Networking"](#), for more details on network configuration.

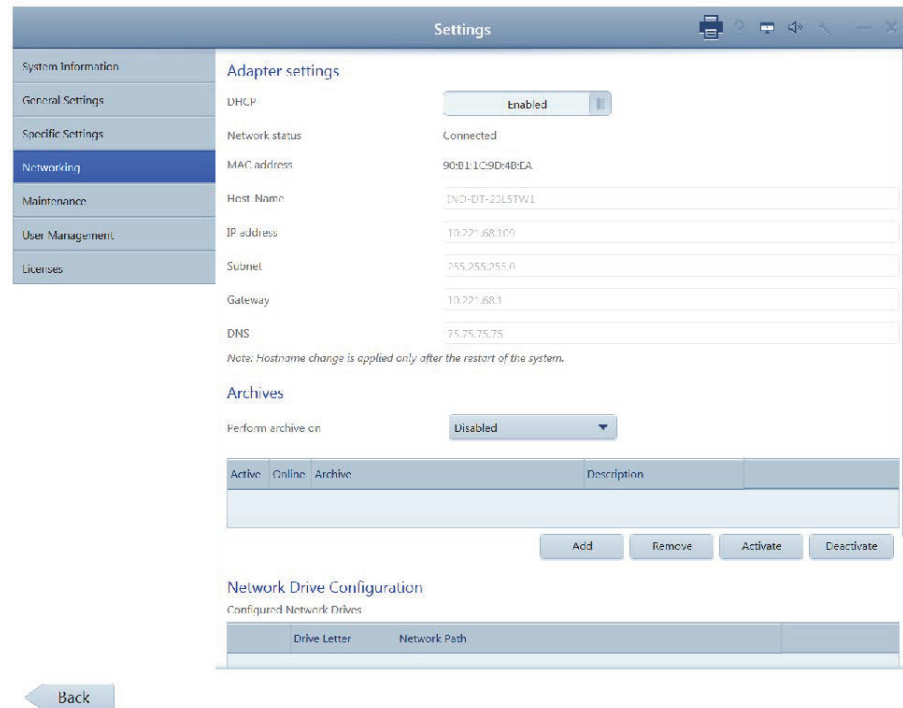

Settings Option	Description
Networking Settings	Shows the network settings.
Adapter settings	<p><b>DHCP Enabled:</b> If the DHCP (Dynamic Host Configuration Protocol) is enabled, the Host name, IP address, Subnet, Gateway, and DNS are filled in automatically and cannot be edited.</p> <p><b>DHCP Disabled:</b> If the DHCP is disabled, you can manually enter or edit this information. Network Status is shown and MAC address is displayed.</p>
Network Drive Configuration	<p><b>Configured Network Drives:</b> Lists available network drives and their connection statuses. Showing the Drive Letter and Network Path. Connected drives are indicated by a green check-mark.</p>
Back	Go back to the previous screen.

The screenshot shows the 'Settings' application window. On the left is a navigation menu with options: System Information, General Settings, Specific Settings, Networking (highlighted), Maintenance, User Management, and Licenses. The main content area is titled 'Settings' and contains the following sections:

- System Information:** IP address (10.174.24.62), Subnet (255.255.254.0), Gateway (10.174.25.254), DNS (10.18.40.96).
- Note:** Hostname change is applied only after the restart of the system.
- Network Drive Configuration:** A table titled 'Configured Network Drives' with columns 'Drive Letter' and 'Network Path'. One drive is listed: 'S:' with path '\\zsqbfs008\SQAtestDB\HFA3'. Below the table are buttons for 'Reconnect', 'Unmap', and 'Map...'. A 'Map...' button is also visible below the table.
- DICOM Configuration:** A toggle switch for 'DICOM network' is currently set to 'Disabled'.

At the bottom left of the settings window is a 'Back' button.

Settings Option	Description
Networking Settings	Shows the network settings.
Archives	Archives is not used in HFA3. The Archive setting should remain Disabled.
Network Drive Configuration	<p><b>Configured Network Drives:</b> Lists available network drives and their connection statuses. Showing the Drive Letter and Network Path. Connected drives are indicated by a green check-mark.</p> <p><b>Reconnect:</b> Attempts to reconnect to the highlighted network drive.</p> <p><b>Unmap:</b> Removes the highlighted network connection.</p> <p><b>Map...:</b> Opens a dialog for connecting to a network drive. Requests a network path and drive letter. Prompts for user name and password.</p>
DICOM Configuration	<p><b>DICOM network:</b> Enables or disables connection to FORUM or an EMR. To use the HFA3 in local database mode, ensure this setting is disabled.</p>
Back	Go back to the previous screen.

## Maintenance

Use the **Maintenance Settings** screen to perform system maintenance actions such as database backup, restore, and perform software updates.

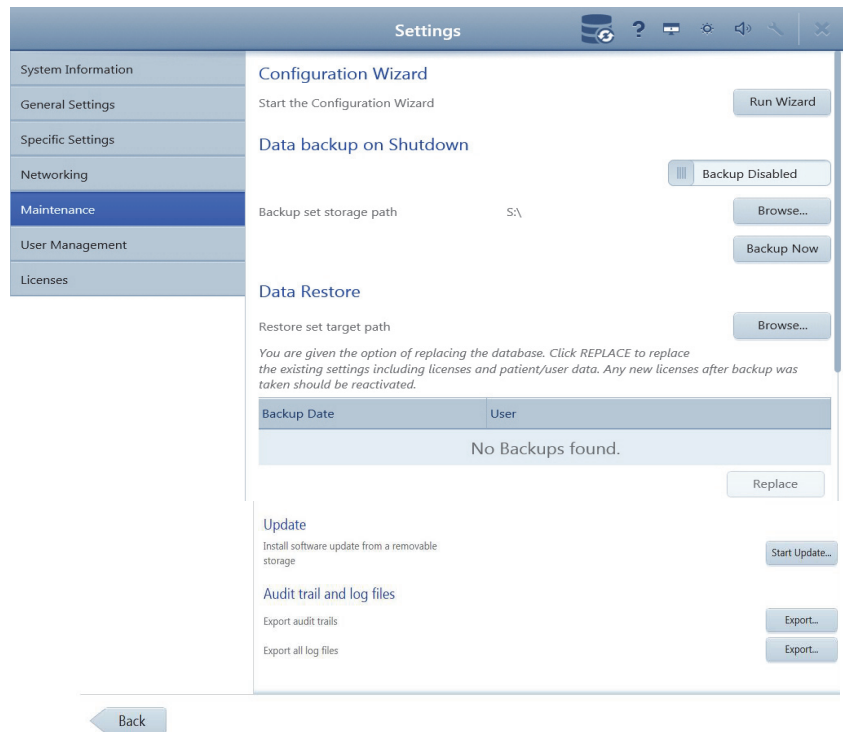

Settings Option	Description
Maintenance Settings	Shows the system maintenance actions.
Configuration Wizard	<b>Start the Configuration Wizard:</b> The <b>Run Wizard</b> button launches the configuration wizard, which guides you through the device configuration.
Data backup on Shutdown	<b>Backup Disabled:</b> Toggle Backup Disabled/Enabled. Enable an automatic backup when shutting down. <b>Browse...:</b> Click on <b>Browse</b> to set the storage path. <b>Backup Now:</b> Click on <b>Backup Now</b> to start the data backup.
Data Restore	<b>Restore set target path:</b> Click on <b>Browse</b> to select the drive where backup files are located. List shows the most current backup by backup date and user. <b>Replace:</b> When backups are available you can restore the database by replacing the data, see <a href="#">"Data Backup on Shutdown and Data Restore," on page 11-1.</a>
Update	<b>Install software update from a removable storage:</b> Click Start Update... to open the Start Update Tool. This action will close the application and launch the update tool. If you are updating from a drive or from a removable storage, make sure to connect to it first. The tool will try to find available updates.

Settings Option	Description
Audit trail and log files	<b>Export audit trails:</b> Click on <b>Export....</b> to open the dialogue, requesting you to select a folder. <b>Export all log files:</b> Click on <b>Export....</b> to open the dialogue, requesting you to select a folder.
Back	Go back to the previous screen.

### User Management

Use the **User Management Settings** screen to configure security settings and add, delete, or modify user accounts.

The screenshot shows the 'Settings' application window. On the left is a navigation pane with 'User Management' selected. The main area is split into 'General' and 'Users' tabs. The 'General' tab contains settings for automatic login, user groups, auto logoff time, and password strength. The 'Users' tab shows a list of users and an 'Add User' button. Below the list are fields for user details and buttons for 'Delete User' and 'Change Password...'. A 'Back' button is at the bottom left.

Settings Option	Description
User Management	<b>General:</b> Settings for user login. <b>Users:</b> List of users.
Automatically login as	Set the default role to login as Doctor or Operator or choose Deactivated. <b>Note:</b> Login screen will be disabled when choosing to activate a Single-User Mode.
Login user group for FORUM users	If the device is in FORUM connected mode, allows you to use your FORUM login as your HFA3 login.
Auto logoff time	Sets the amount of system idle time, in minutes, before the user is automatically logged off.
Password strength	Sets the requirements for passwords: <ul style="list-style-type: none"> <li>• Simple - no requirements.</li> <li>• Complex - password must have at least six characters and be either a mix of upper and lower case letters or a mix of letters and numbers.</li> </ul>
Users	Lists current users and the administrator and emergency user. <b>Add User:</b> Click on Add User to open a form to add an user. Complete the form, choose a role (Administrator, Doctor, Operator) and click on Add User to add. <b>Delete User:</b> Select the user you want to delete and click on Delete User. <b>Change Password...:</b> To change a password, highlight the user, and click on Change Password... Next screen asks you to fill in a new password, to repeat the new password and click on Reset password.

### Licenses

Use the **License Settings** screen to manage device licenses. License activation, return, and repair can be done online or offline.



Note: You must perform a backup after license activation or license support actions if Data backup on shutdown is not activated.



Note: Settings with a circled arrow icon  require a restart to become active.

### Manage Licenses Online

To manage licenses online, enter the **Activation ID** for the license in the **Activation IDs field** for the desired action, then click the appropriate button (**Activate**, **Return**, or **Repair**). Contact ZEISS service to obtain an activation ID for a new license.

### Manage Licenses Offline

1. If the device does not have a network connection, connect a USB drive to the device.
2. Enter the **Activation ID** and select **Create...** to create a requirement file.
3. Submit the requirement file to ZEISS Service. You will receive an activation file.
4. Select **Import...** to import the activation file

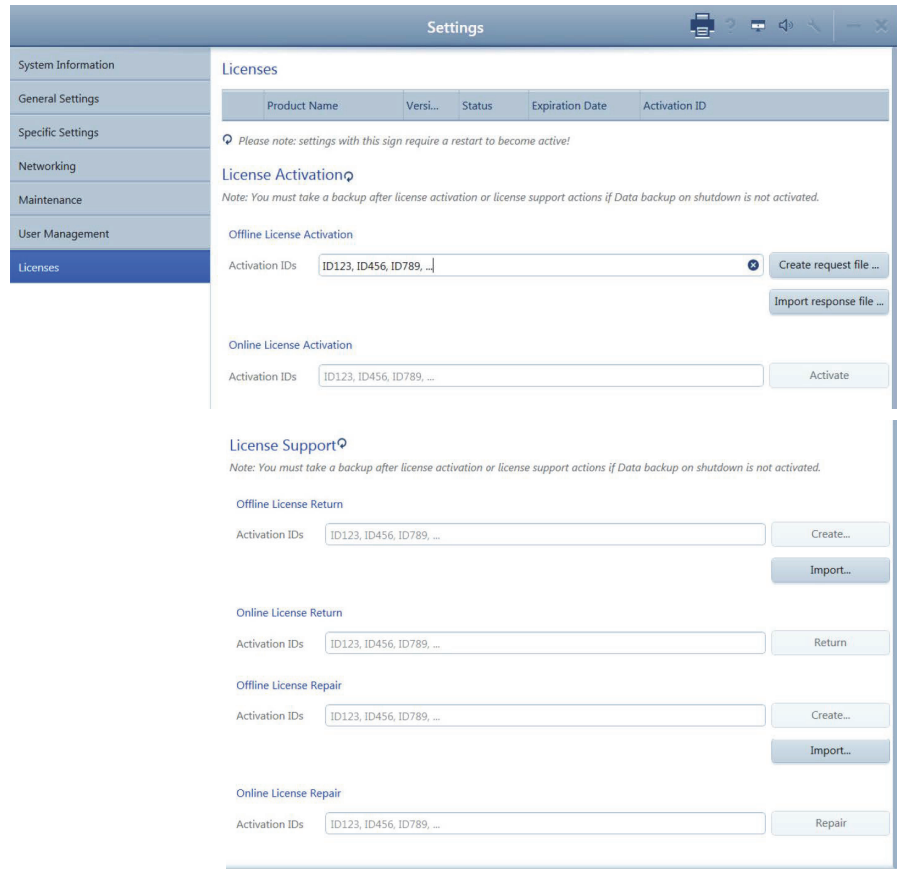

[Back](#)

Settings Option	Description
Licenses	Lists current licenses, their product name, Version, Status, Expiration Date and Activation ID.
License Activation	<b>Offline License Activation:</b> Enter the Activation ID and click on <b>Create request file...</b> or <b>Import response file...</b> to open the dialogue. <b>Online License Activation:</b> Enter the Activation ID and click on <b>Activate</b> .
License Support	Returns or repairs existing licenses. <b>Offline License Return:</b> Enter Activation ID and click on <b>Create</b> or <b>Import</b> . <b>Online License Return:</b> Enter Activation ID and click on <b>Return</b> . <b>Offline License Repair:</b> Enter Activation ID and click on <b>Create</b> or <b>Import</b> .

## (4) Setup and Testing

### Perform Threshold or Suprathreshold Test

Overview of patient setup and Threshold or Suprathreshold testing on the HFA3:

1. Select Patient.
2. Test Setup.
3. Set up Patient for Testing.
4. Preliminary Tests (Optional).
5. Administer the Test (one or both eyes).
6. Review and Save Results.

#### Select Patient

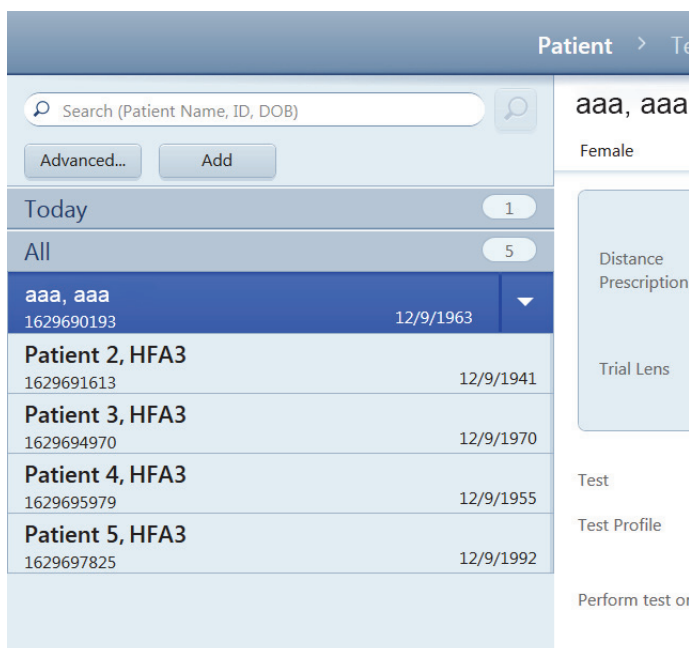

The **Patient** screen displays a list of patients and search options on the left. In **local database** mode with all DICOM/EMR network settings **off**, existing patients are listed under **All** (a counter on the right side shows how many patients are available).

Patients tested that day and newly created patients are listed under **Today** (a counter on the right side shows how many patients are available).

If the HFA3 is connected to FORUM or an EMR system, scheduled patients and newly created patients are listed under **Today**.

To refresh a worklist, select the refresh icon on the **Today** bar. Patients found through a search are listed under **Search Result**.

The **Reports** and **Tests** buttons are displayed at the bottom of the screen and can be used to print/view/export patient tests and test reports. See [Chapter \(6\), "Data, Tests & Reports"](#).

The **Reports** and **Tests** button are not displayed if data are being exported to FORUM. Perform these functions in FORUM using FORUM Glaucoma Workplace.

Once a patient has been selected, patient information and testing options are displayed on the right.

#### Patient Search

To quickly find a patient:

1. Type a few letters of the last or first name, the ID number, or Date of Birth (DOB) in the search field.
2. Select the **Search** icon . Any patients containing the search term in any part of any field will be returned.
3. Select the patient from the resulting list.



Note: If the patient was flagged after Data Synchronization after an import from another HFA3 instrument, or after a serial import from an HFAII-i, an exclamation point appears next to the patient. When you select the patient, you must choose whether to merge the patient with the suspected duplicate or maintain the two patients as separate records before proceeding.

To find a patient using additional search options:

1. Select **Advanced** to access the **Search** screen. The advanced search terms on this screen will not affect retrieval of non-DICOM EMR work lists when in Retrieve Only mode.

2. If the HFA3 is connected to FORUM or an EMR system, you may choose between **All Patients** and **Scheduled Patients**. Select **Scheduled Patients** and choose between **Today**, **Tomorrow**, **Week**, or **Time Span** from the drop-down menu.
3. Enter a combination of Last name, First name, Patient ID, Referring physician, Accession number, Visit date), Date of birth, and Modality.  
**Note:** Many of the search terms listed above are only effective in certain contexts. A search on **Referring Physician** and **Date of Birth** will work only when **All Patients** has been selected. You can only search on **Accession Number**, **Modality**, with use of a date range, when connected to EMR systems that support these searches. **Scheduled Patients** must also be selected when searching for an Accession number.
4. Select **Search** to search the patient database.
5. Highlight a patient from the search results and choose the **Select** button.
6. Select the **Reset** button to clear all fields.

### Add New Patient

If the patient is not in the database create a new patient record by selecting the **Add** button. Fill in the required entries: Last name, First name, Gender, and Date of Birth (DOB). For DOB, type in month, day, then year, or choose the correct date from the drop-down calendar and select **OK**. Patient age will then appear. Patient ID is automatically generated if the Auto-generate patient ID setting is turned on under “[General Settings](#),” on page 3-11. The patient is identified in the device by ID and DOB.

If the HFA3 is connected to FORUM, the new patient is saved to the FORUM archive if data export has been enabled. For EMR systems, we recommend adding new patients to the system and importing to the instrument using work lists.



Note: It is possible to create two records for the same patient with the same name, gender, DOB, and Patient ID if the Issuer of ID differs between the two records. Do not add a new patient unless you are sure the patient does not currently exist in the database.

### Confirm or Change Patient Information

Review and confirm that the patient information displayed on the screen is correct.

### Local Database Mode

Change Patient Information by selecting First Name, Last Name, Gender, ID number and/or Date of Birth to edit the fields. Changes are visible only after the patient selection screen is refreshed by navigating away from and back to the screen, or by selecting another patient and then selecting the first patient again.



Note: All changes are logged.

### FORUM and EMR Connected Modes

Patient records obtained from FORUM, DICOM compatible, and non-DICOM EMR systems should not be edited on the instrument. Changes should be made to the patient record stored on the server and the patient record retrieved again from the server prior to testing. Patient records will be updated.

When patient records are imported from an EMR, they are reconciled with local records as follows:

- Same ID and Issuer of ID, different name, date of birth, or gender: The local record is updated to match the EMR record.
- Different ID or Issuer of ID: A new patient record is generated.



Some EMR systems allow records that are missing key identifying information. The HFA3 will automatically add a default (Unknown) for missing names, but will reject patient records that do not contain a Patient ID or DOB.

When the same patient has multiple records, reports that include multiple exams, such as a GPA Summary report, will not include all of the patient's data. This may happen, for example, when a practice implements an EMR after records already exist on the HFA3. Each existing patient's new EMR record will then need to be merged with the local record the first time the patient is scheduled for an exam after the EMR is implemented. To merge two patient records, see ["Merge Patients on the HFA3," on page 6-6](#). Merging patients can be done before or after testing; however, if it is done after testing, any reports that include data from multiple exams must be manually regenerated to include all available exams for the patient.



Caution: Every patient has an identifier that consists of Name, Date of Birth, Patient ID, and Issuer of ID. To avoid unintentional automatic merging of patient records, VERIFY a unique combination of Name, Date of Birth, Patient ID, and Issuer of ID exists when patients are copied, transferred, retrieved from an archive, or restored from a backup.

### Enter Distance Prescription and Trial Lens Data (Optional)

If this is the patient's first visual field test, enter the patient's Distance Prescription values for Sphere, Cylinder, and Axis in the corresponding text fields for each eye. For negative prescriptions you must enter a minus (–) as the first character. To delete any entry select the value then select the  icon. Invalid entries will display a red outline. Select the text box to view an error message. Previously entered prescription values will appear automatically.

The HFA3 automatically calculates and displays Trial Lens values. You can manually override the Trial Lens value by typing in the desired value, which will then be displayed in blue font. To calculate Trial Lens values manually, see ["Determine Trial Lens," on page B-1](#).

Trial Lens data will be labeled Liquid Trial Lens if the Liquid Trial Lens feature is installed on the instrument in place of the manual trial lens holder. This feature is only available on Model 860 and automatically adjusts the lens to the entered prescription. The Liquid Trial Lens does not correct cylinder prescriptions, but you are able to substitute the spherical equivalent within the range of +8.00 and –8.00 diopters (D). To have the trial lens correction include cylindrical correction or for out of range values, use manual trial lenses (see ["Replace the Liquid Trial Lens with the Manual Trial Lens Holder \(Model 860 only\)," on page 4-5](#)). We recommend using manual trial lenses for cylindrical refractive errors >1.75 D.



Note: If there is no prescription, place the Liquid Trial Lens holder in the down position or enter a value of zero (0). If the Distance Prescription fields are left blank they are interpreted as 0 and the Liquid Trial Lens will automatically add an age correction and apply that lens power. Be sure to enter the patient's Distance Prescription as this will avoid the need to enter the prescription at each visit. Do not touch the Liquid Trial Lens if the icon is flashing red .

### Test Setup

#### Select the Test

For an existing patient the previous test information is automatically loaded and displayed. Otherwise, the **24-2 SITA FASTER** is the default test. For Modality Work Lists, if the patient has multiple procedures scheduled for the same day, select a test from the list. In the absence of any previous test information the default test profile is displayed. See ["Set up Test Profiles," on page 4-24](#).

To change the test, select the Test Profile menu to display the list of available tests and select a test from the list. You may also [Select Test Parameters](#) to change the test. The modified test profile will be displayed.

### Select Eye

Under the Perform test on drop-down menu select which eye to test: **OD** (Right), **OS** (Left), or **Both** (the default). The **Binocular** option appears when the Suprathreshold Esterman Binocular test pattern is chosen.

Under the Start with drop-down menu select which eye to test first. Choose the default using the "Specific Settings," on page 3-13.

### Note

The **Note** feature is available on multiple screens. Selecting **Note** opens a text box for typing notes about the test, which will be displayed on reports. **Cancel** or **Save** your note once it is written. Touch or click the  to close the text box.

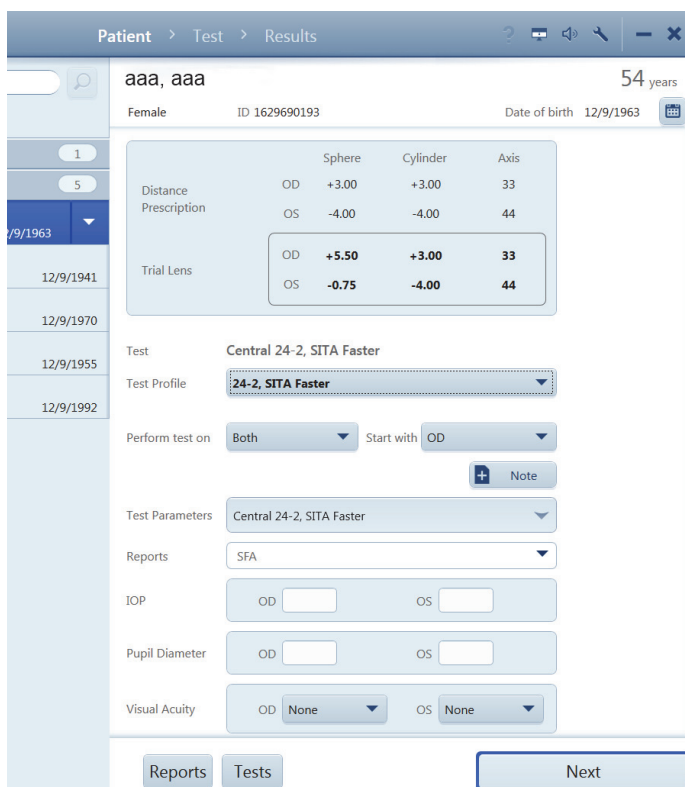

The screenshot shows a patient information screen for 'aaa, aaa', a 54-year-old female with ID 1629690193 and date of birth 12/9/1963. The screen displays test parameters for a 'Central 24-2, SITA Faster' test. The 'Distance Prescription' table shows OD +3.00, Cylinder +3.00, Axis 33, and OS -4.00, Cylinder -4.00, Axis 44. The 'Trial Lens' table shows OD +5.50, Cylinder +3.00, Axis 33, and OS -0.75, Cylinder -4.00, Axis 44. The 'Test' is set to 'Central 24-2, SITA Faster' and the 'Test Profile' is '24-2, SITA Faster'. The 'Perform test on' is set to 'Both' and 'Start with' is 'OD'. There is a '+ Note' button. The 'Test Parameters' are set to 'Central 24-2, SITA Faster'. The 'Reports' are set to 'SFA'. The 'IOP' and 'Pupil Diameter' fields are empty. The 'Visual Acuity' is set to 'None' for both eyes. At the bottom, there are 'Reports', 'Tests', and 'Next' buttons.

### Select Test Parameters

To change the parameters of a test, scroll down on the screen and touch or click on the Test Parameters menu to view the current settings. Select each drop-down menu to view a list of available options, and make changes as needed by selecting the desired parameters. After making a new selection, each drop-down menu will automatically close. To close the entire Test Parameters menu, select the top bar of the menu or select **OK**.

Under Test Parameters, the Test Type drop-down menu allows a choice of:

- Threshold
- Suprathreshold
- Kinetic

Selecting the Test Type will automatically display the Test Parameters available for that Test Type. Choosing certain settings will also limit the availability of other choices (see [Appendix \(A\), "Test Patterns & Parameters"](#), for further details).

Test Parameters for Threshold and Suprathreshold Testing are:

- Test Pattern
- Test Strategy
- Suprathreshold Mode (Suprathreshold only)
- Blue-Yellow
- Stimulus Color
- Stimulus Size
- Fixation Monitoring
- Fixation Target
- Test Speed

- Foveal Threshold (Threshold only - Models 840, 850, and 860)
- Fluctuation (Threshold only)



**CAUTION:** If the Blue-Yellow Test parameter has been chosen, allow the lamp used for Blue-Yellow testing to warm-up for seven (7) minutes before proceeding with a test.

### Reports

This drop-down menu allows you to select available report types for automatic printing and/or exporting at the end of the test. Change the reports by highlighting the report types of interest. To remove a report from the list, deselect the report type. Reports for automatic end of test printing and/or exporting may also be selected when reviewing test results at the end of testing. See “Review and Save Results,” on page 4-14.

### Additional Information (Optional)

If desired, enter IOP (intraocular pressure), Pupil Diameter (available only if Auto Pupil is off), and Visual Acuity data.

### Proceed to Patient Setup

Confirm test information and select the **Next** button to proceed.



Note: A notice will display to extend the visor if you have chosen the Blue-Yellow test parameter (Models 850 and 860). Extend the visor and allow the patient to adapt to the yellow bowl for about three (3) minutes before testing. A reminder will display to retract the visor when the test is complete.

### Set up Patient for Testing

To use manual trial lenses follow the procedure on page 4-6. For Model 860 the Liquid Trial Lens will automatically adjust the lens power. Make sure that the Liquid Trial Lens feature is in the upright position and proceed to “Occlude the Non-Test Eye,” on page 4-7.

If trial lens data are out of range or the Liquid Trial Lens is not functioning, a notice will display before each eye exam. Follow the procedure in the next section to replace the Liquid Trial Lens with the manual trial lens holder.



Note: Trial lenses and the Liquid Trial Lens are not needed for peripheral testing. A notice will display requesting that you place the trial lens holder in the down position.

### Replace the Liquid Trial Lens with the Manual Trial Lens Holder (Model 860 only)

Remove the Liquid Trial Lens holder. Be careful not to touch the surface of the lens.

1. Move the chin rest to the half-way down position and move the lens holder down slightly from the full upright position.
2. Rest your hand on the chin rest and grasp the upper portion of the holder.

3. Lever the detachable lens holder off the base of the shaft.



**Note:** Be careful not to touch the inside of the bowl with your hand or the lens holder.

4. Tilt the lens holder and move it out of the bowl.

To attach the manual trial lens holder:

1. Place the end of the manual lens holder over the lower portion of the shaft.
2. Move the detachable lens holder down the shaft until it stops.
3. Turn the detachable lens holder until it is facing front and you feel the positioning notch.
4. Push the detachable lens holder down until it seats in place.
5. Touch the Live Eye monitor located on the left of the screen to move the chin rest back up to the approximate desired location for the patient.

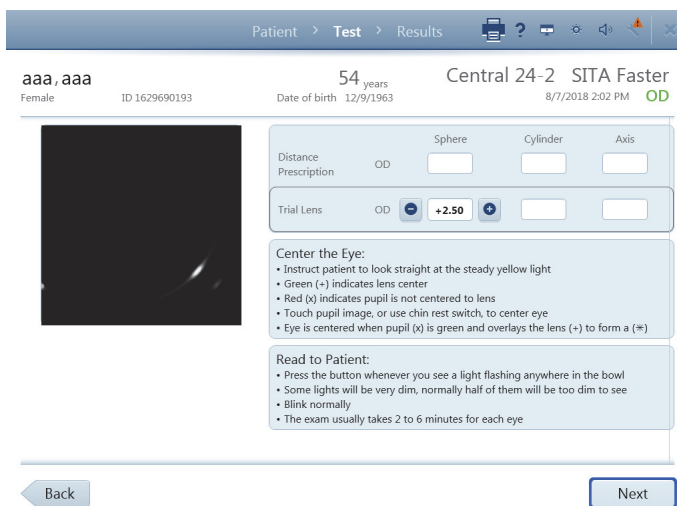

### Use Manual Trial Lenses

To insert lenses into the manual trial lens holder:

1. Use the Trial Lens values on the **Test** screen to locate the correct trial lens for the eye to be tested. Change distance refraction and trial lens information in this screen by selecting a particular field.
2. Move the trial lens holder into an upright position from its storage position in the bottom of the bowl by putting a finger(s) under the lens holder from the outside and lifting (**Figure 3-1, A**).
3. Place the cylinder lens, if indicated, in the slot farthest away from the patient and align the axis (**Figure 3-1, B**).
4. Place the sphere lens in the slot closest to the patient (in front of the cylinder lens) (**Figure 3-1, C**).

Figure 4-1 Insert the trial lens

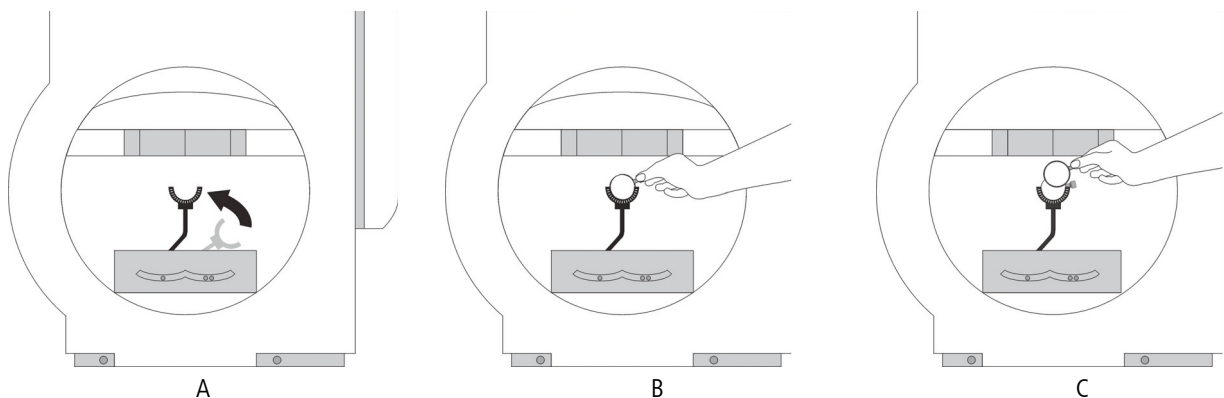



Note: Use only the narrow rimmed type of trial lenses. The wide rimmed variety will interfere with the patient's peripheral vision and adversely affect test results. Move the lens handle towards the patient's temporal side so it does not interfere with the patient's eyebrow or nose.

To remove the manual trial lens holder first remove the lenses, then follow the instructions for removing the Liquid Trial Lens holder on page 4-5.

### Occlude the Non-Test Eye

Position the eye patch over the non-test eye so that it completely blocks vision from that eye. Make sure nothing interferes with the vision of the test eye.

### Esterman Testing

The Esterman tests are designed to be done using a patient's everyday correction. If the patient does not require glasses to function normally perform the test without correction. If the patient does wear glasses to function normally, perform the Monocular or Binocular test using the patient's glasses. Do not use trial lenses or the Liquid Trial Lens. An eye patch must be used when testing with the Monocular version of the Esterman test.

To position the patient for the Binocular test, do the following:

1. Move chin rest to the far-right position.
2. Have patient place chin in the chin cup on the left.
3. Adjust chin rest to center eye monitor between patient's eyes.



Note: You will not be able to monitor the patient's fixation during the Binocular test.

### Position the Patient

To facilitate patient positioning, the chin rest is divided into two cups: one marked with BLUE for right eye testing; the other marked with WHITE for left eye testing. We recommend the use of a power table to more easily adjust the instrument to comfortably align with the patient during testing.

- Seat the patient and adjust the table and seat height to allow the patient to sit comfortably erect.
- Instruct the patient to place his or her chin on the appropriate side of the chin rest, and then assist with bringing the forehead against the forehead rest.
- Have the patient slide the chair close to the instrument.
- Check that the patient is relaxed and holding the patient response button. The instrument will alert you if the patient response button is unplugged.
- Instruct the patient to look at the fixation light.

### Centering the Eye

It is important to align the patient's eye to the center of the trial lens, which may not be in the center of the eye image on the screen. The following on-screen indicators guide you to centering the patient's eye:

- A red "x" indicates the pupil location when it is NOT centered.
- A green plus sign "+" indicates the center of the lens position.
- The "x" of the pupil location turns green when it is centered and overlaid with the green plus sign "+" of the lens. The resulting centered icon looks like a green star .

Patient > Test > Results

aaa, aaa  
Female ID 1629690193

54 years  
Date of birth 12/9/1963

Central 24-2 SITA Faster  
8/7/2018 2:54 PM OD

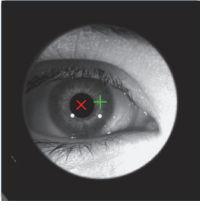

Distance Prescription	Sphere	Cylinder	Axis
OD			

Liquid Trial Lens	OD	OS
	+2.50	

**Center the Eye:**

- Instruct patient to look straight at the steady yellow light
- Green (+) indicates lens center
- Red (x) indicates pupil is not centered to lens
- Touch pupil image, or use chin rest switch, to center eye
- Eye is centered when pupil (x) is green and overlays the lens (+) to form a (\*)

**Read to Patient:**

- Press the button whenever you see a light flashing anywhere in the bowl
- Some lights will be very dim, normally half of them will be too dim to see
- Blink normally
- The exam usually takes 2 to 6 minutes for each eye

Back Next

1. Touch the center of the pupil in the Live Eye monitor, or use the manual chin rest switch, to move the chin rest and align the eye to the center of the lens target, indicated by a green plus sign "+".

The eye is centered when the "x" of the pupil turns green and is overlaid on the green plus sign "+", resulting in a green star



Patient > Test > Results

aaa, aaa  
Female ID 1629690193

54 years  
Date of birth 12/9/1963

Central 24-2 SITA Faster  
8/7/2018 2:54 PM OD

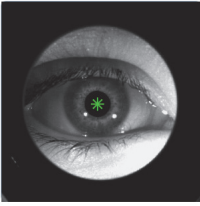

Distance Prescription	Sphere	Cylinder	Axis
OD			

Liquid Trial Lens	OD	OS
	+2.50	

**Center the Eye:**

- Instruct patient to look straight at the steady yellow light
- Green (+) indicates lens center
- Red (x) indicates pupil is not centered to lens
- Touch pupil image, or use chin rest switch, to center eye
- Eye is centered when pupil (x) is green and overlays the lens (+) to form a (\*)

**Read to Patient:**

- Press the button whenever you see a light flashing anywhere in the bowl
- Some lights will be very dim, normally half of them will be too dim to see
- Blink normally
- The exam usually takes 2 to 6 minutes for each eye

Back Next

2. Ask the patient if the fixation light is in focus. If the fixation light is out of focus you may need to adjust the refractive correction.

**Note:** The HFA3 saves the last chin rest position for each patient eye for a particular patient and uses the saved chin rest position at the start of each eye exam.

**Note:** When using Liquid Trial Lens on HFA3 Model 860, move the lens close to the patient's eye but avoid hitting lashes. If the lens is too close to the eye, the eye appears too dim on the monitor and may adversely affect Gaze Tracking.

3. Read the instructions shown on the screen to the patient. The **Back** button returns to the previous screen. Select **Next** or **Start Test** to proceed.

### Preliminary Tests (Optional)

#### Test Foveal Threshold (Models 840, 850, and 860)

This option is only available for Threshold testing. Go to **Test Parameters** and make sure the Foveal Threshold setting is set to **On**. The Foveal Threshold Test measures the sensitivity of the central part of the macula, the fovea.

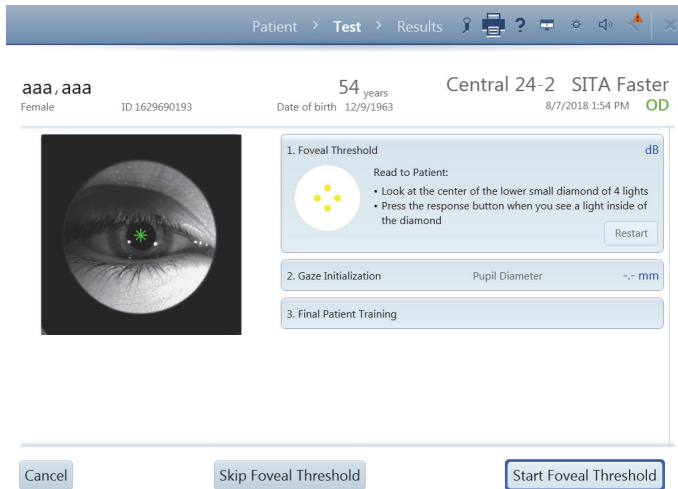

1. The **Foveal Threshold** dialog box should be automatically expanded on the screen. If it is closed, expand the box by touching it to reveal patient instructions.

2. Instruct the patient to look at the center of the lower diamond of fixation lights and press the response button whenever they see a light inside of the diamond.

3. Select **Start Foveal Threshold**. When Foveal Threshold is complete, the decibel (db) result displays on the top line and an audible signal will occur.

4. Select **Skip Foveal Threshold** to proceed with the test without a Foveal Threshold.

5. Select **Cancel** to access several options:

- Cancel Current Eye Test and Test Next Eye (results are not saved).

- Cancel Entire Test (results are not saved).

- Return to Current Eye Test.

6. Select **Restart** in the **Foveal Threshold** box to restart test.



Note: The only way to pause the Foveal Threshold test is by pressing and holding the patient response button. To resume the test, release the patient response button.

### Perform Gaze Initialization (Models 840, 850, and 860)

To track whether the patient is fixating properly while stimuli are presented, go to **Test Parameters**, from the drop-down menu choose **Fixation Monitoring**, and select **Gaze Tracking** or **Gaze/Blind Spot**.



Note: Make sure to adjust the eye position before performing gaze initialization.

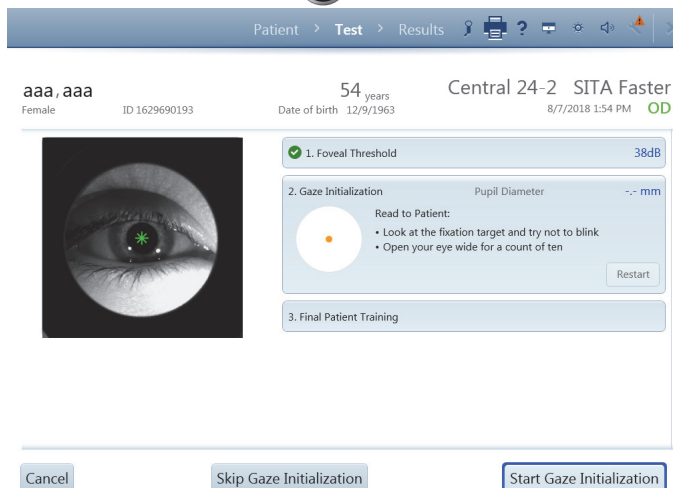

1. The Gaze Initialization dialog box should be automatically expanded on the screen. If it is closed, touch the box to expand it and read the instructions to the patient.

2. Select **Start Gaze Initialization**. Gaze initialization occurs very quickly. Make sure the patient is properly fixating before you select the button.

3. An audible signal will occur when Gaze Initialization is completed.

**Note:** If the **Auto Pupil** setting is **On** (see ["Specific Settings,"](#) on page 3-13) the pupil diameter will display with an asterisk.

To proceed with the test without Gaze Tracking, select **Skip Gaze Initialization**. If Head Tracking or Vertex Monitoring are on, a pop-up menu will appear with a warning. Choose **Disable Gaze Tracking** or **Cancel**. Select **Cancel** for cancellation options or **Restart** in the Gaze Initialization box to restart the test.

If Gaze Initialization fails a notice displays providing other options:

- Re-Try Gaze Initialization.
- Turn Off Gaze Tracking.
- Turn On Blind Spot Monitoring (available if blind spot monitoring is disabled). A message will display allowing you to disable Gaze Tracking or Cancel.
- Turn Off All Fixation Monitoring (available if blind spot monitoring is enabled).

Confirm your choice in the next screen.

Disabling Gaze Tracking will turn off Head Tracking and Vertex Monitoring (if enabled). Confirm or cancel your choice.

See ["Troubleshooting Table,"](#) on page C-3 for possible causes and solutions for Gaze Initialization failure and Gaze Tracking issues.



Note: Fixation Monitoring is not available for Esterman Binocular tests.



## Administer the Test

### Final Patient Training

The Final Patient Training dialog box should be automatically expanded on the screen. If it is closed, touch the box to expand it and read the instructions to the patient.

Select the **Start Test** button.

### Live Eye Monitor

The Live Eye monitor is used to monitor the patient's gaze. Automatic Head Tracking (Models 840, 850, and 860), if enabled, will attempt to keep the eye centered in the Live Eye monitor. Head Tracking will work only if the trial lens/Liquid Trial Lens is in use and Gaze Initialization is successful. Otherwise, touch the center of the pupil on the monitor or use the manual chin rest controls to re-align the eye.

### Test Pattern

To the right of the Live Eye monitor is the test pattern, which displays the point pattern and the results in gray scale shading. During Threshold testing the test responses can be toggled to numerical values using the # icon next to the test pattern. See "Specific Settings," on page 3-13 to set the default display.

## Reliability Indices

The reliability indices are displayed on the right side of the monitoring screen. The types of indices displayed depends on test type and settings used and include **Blind Spot Errors** (Fixation Losses), **False Positives**, and **False Negatives**. For details see "Reliability Indices," on page 6-12. The software will give an audible alert (after waiting for 3 seconds or more) to the user if a Fixation Loss occurs and three or more of the last ten fixation checks have been errors.

## Progress Bar

An on-screen progress bar along the bottom of the screen provides a graphic of test progress and records the relative magnitude of gaze errors if Gaze Tracking is active.



Note: Gaze error magnitudes appear larger on the HFA3 than those on older HFA models.

Stimulus responses are recorded on the bar. To the right of the progress bar is the elapsed time. Gaze errors are recorded as red marks at the time point that the gaze error occurred. Upward markings indicate that the test eye deviated from the fixation target at the time of stimulus presentation. The higher the marking, the greater the deviation. Downward marks (Not Detected) indicate that the system was unable to determine the gaze either due to blinks or other reasons.

### Suprathreshold Responses

Suprathreshold-specific test responses and values are recorded on the right side of the screen beneath the error responses. The types of responses recorded depend on the test selected and includes:

- Points Seen
- Points Not Seen
- Stimulus Int. (Intensity)
- Relative Defects
- Absolute Defects
- Cen.Ref.Lvl (Central Reference Level)
- Per.Ref.Lvl (Peripheral Reference Level)

For further details refer to “[Suprathreshold Reports](#),” on page 6-15.

### Change Fixation

Select **Fixation** at any time to stop testing and access the following possible options. Different options are available depending on the current settings and parameters.

- Retry Gaze Initialization
- Retry Blind Spot Detection
- Turn On/Off Blind Spot Monitoring
- Turn Off All Fixation Monitoring
- Turn Off Gaze Tracking
- Turn Off Head Tracking (if enabled)
- Turn Off Vertex Monitoring (if enabled)



Note: Disabling Gaze Tracking will turn off Head Tracking and Vertex Monitoring (if enabled). Confirm or cancel your choice.

### Note

See the feature “[Note](#),” on page 4-4.

### Test Speed

Select the Test Speed feature at any time to choose one of the following options:

- Normal
- Slow

Select **OK** to change the test speed or **Cancel** to return to the test without changing the test speed.

### Pause the Test

If **Pause** is selected, testing stops and the following options are available:

- **Resume** - Resumes the test. The Start of Test sound will occur.
- **Restart** - Select **Restart Exam** to start the same test over. You will need to confirm your choice. All data from the current exam are deleted. Otherwise, select **Return to Current Test**. The Start of Test sound will occur when the test is restarted.
- **Cancel** - To cancel the current eye test and test the next eye (if both eyes were selected for testing), cancel the entire test, or return to the current eye test.



Note: The **Cancel** option is always available during the test. To change test type or other parameters (except test speed and fixation) the test needs to be canceled.



Note: The patient can pause the test by holding down the response button, which will result in an on-screen message and an audible alert. The Start of Test sound will occur when the patient releases the button and the test is resumed.

### RelEYE (Models 850 and 860)

Turn RelEYE on to record images of the patient's eye during the presentation of each stimulus (see "Specific Settings," on page 3-13). This allows the operator to determine how well the patient was fixating at a specific test point.

Eye images will be transferred along with the patient exam data to FORUM. When the instrument is in local database mode RelEye images can only be viewed during and directly at the end of a test, prior to selecting **Review Results** (see page "Review and Save Results," on page 4-14).

The screenshot displays the RelEYE software interface. At the top, it shows navigation tabs for 'Patient', 'Test', and 'Results'. Patient information includes 'aaa, aaa', 'Female', 'ID 1629690193', '54 years', 'Date of birth 12/9/1963', 'Central 24-2', 'SITA Faster', '5/8/2018 4:37 PM', and 'OD'. Test results show 'Blind Spot Errors 0/12', 'High Sensitivity 0', and 'False Negative 0/2'. A central visual field chart shows a grid of test points with a targeting icon. To the left, four eye images are displayed. Below the chart, a 'Gaze Errors' graph shows 'Responses Not Detected' and 'Elapsed Time 02:35'. At the bottom, there are buttons for 'Note', 'Test Speed', 'Fixation', 'Cancel', and 'Pause'.

To review RelEye images:

1. Select a tested point on the test pattern. Already tested points are displayed as shaded circles. An icon will appear centered over the point, along with associated, multiple eye images to the left.
2. Drag the targeting icon over different test points to view the recorded eye images. Touch or click the  icon to return to a view of the live eye.

RelEYE is available for the following tests only:

- Threshold SITA-Standard tests (Central 30-2, Central 24-2, Central 10-2, and Peripheral 60-4 test patterns)
- Suprathreshold Central 76
- Suprathreshold Esterman Monocular

### End the First Eye Test

When the test for the eye is complete, an alert sounds and a message displays. Select **OK**.



If both eyes were selected for testing, the instrument returns to the **Test** screen:

- Select **Start (Other) Eye** to set up testing for the other eye. Test data for the first eye will be locally saved. To skip the next eye, select **Skip (Other) Eye** to go directly to the **Results** screen.
  - Select **Restart** to delete the results and test the first eye again.
  - Select **Cancel** to cancel the entire exam and delete the results.
- Note:** You must confirm or cancel your choice if you select **Restart** or **Cancel**.

### Test the Second Eye and End Test

The screen automatically displays the Live Eye image, refractive correction, and trial lens information of the next eye being tested. Set up the patient and test the second eye following the same procedures used for the first eye.

When the second eye is complete, select **OK**. In the next screen, select **Review Results** to view test results, restart the test, or cancel the test.



**Note:** To cancel the entire test including results from the first eye, you will need to manually delete the results from the first eye. See ["Delete Tests,"](#) on page 6-4 to do this on the instrument. If the instrument is set up to export data to FORUM, manually export data to the server (**Settings > Network > Manual data export**) and delete the exam from FORUM. Results from the first eye should also be manually exported if the second eye exam fails and you would like to save data from the first eye.

### Review and Save Results



**Review Results** displays the test results for each eye tested. The operator can add notes to the exam. Final changes to reports can be made in the **Reports** drop-down list before saving the exam or sending exam data to the server archive. If you do not want reports to be printed and/or exported automatically, deselect reports.

Select **Save and Exit**. A message will display when exam data are being successfully saved, either to the local database or to the server archive. A message will also display if the exam has not been successfully saved.

The HFA3 then returns to the **Patient** screen.

## Perform Kinetic Test

The HFA3 Kinetic feature emulates manual standard Goldmann perimetry on Models 840, 850, and 860.

Overview of patient setup and testing on the HFA3:

1. Select Patient.
2. Test Setup.
3. Set up Patient for Testing.
4. Administer the Test (one or both eyes).
5. Review and Save Results.

### Select Patient

To select, add, and change patient information follow the instructions in section “Perform Threshold or Suprathreshold Test,” on page 4-1.

### Test Setup

This section applies to both Kinetic tests. For further details see “Administer the Test (Manual Kinetic),” on page 4-16 and “Preset Kinetic Tests,” on page 4-20.

### Select the Test

For further details see “Select the Test,” on page 4-3.

### Select Eye

Next to **Perform test on** select from the drop-down menu which eye to test: **OD** (Right), **OS** (Left), or **Both** (default). Next to **Start with** select from the drop-down menu with which eye, **OD** or **OS**, you want to start.



Note: The **Binocular** option appears when **Manual Kinetic** is chosen as the Test Pattern under Test Parameters. This option will also appear if a custom kinetic pattern is chosen. See “Create Custom Test Patterns,” on page 4-22.

The screenshot shows the HFA3 software interface. At the top, there are navigation tabs for Patient, Test, and Results. A search bar is present with the text "Search (patient name, ID, DOB)". Below the search bar, there are buttons for "Advanced..." and "Add". A list of patients is shown, with the selected patient being "aaa, aaa" (ID: 146174105, DOB: 3/13/1954). The patient details panel shows "aaa, aaa" (Female, ID: 1629690193, Date of birth: 12/9/1963, 54 years). The "Trial Lens" section shows OD +5.25 and OS +1.25. The "Test" section shows "Manual Kinetic" selected. The "Test Profile" is a dropdown menu. The "Perform test on" dropdown is set to "Both", and "Start with" is set to "OD". There is a "Note" button. The "Test Parameters" section shows "Manual Kinetic" selected, with "Test Type" set to "Kinetic" and "Test Pattern" set to "Manual Kinetic". At the bottom, there are "Reports" and "Tests" buttons, and a "Start Test" button.

### Note

See the feature “Note,” on page 4-4.

### Test Parameters

For a new patient, go to **Test Parameters**.

From the Test Type drop-down menu, select **Kinetic** and choose the desired **Test Pattern**.

If **Manual Kinetic** is chosen you will manually determine stimuli and test points during the test.

### Reports

See “Reports,” on page 4-5.

### Additional Information (Optional)

If desired, enter IOP (intraocular pressure), Pupil Diameter (available only if Auto Pupil is off), and Visual Acuity data.

### Proceed to Patient Setup

Select **Start Test** to proceed.

### Set up Patient for Testing

Follow the steps for setting up the patient outlined in section "Perform Threshold or Suprathreshold Test," on page 4-1.



Note: You will need to extend the visor for any binocular test. Do not use an eye patch.

### Administer the Test (Manual Kinetic)

Use the Manual Kinetic **Test** screen to present stimuli to the patient, and to monitor the patient. To test the patient using a preset test pattern, see "Preset Kinetic Tests," on page 4-20.

### Live Eye Monitor

Use the Live Eye Monitor to center the eye during the test. Touch the on-screen pupil image to move the chin rest and center the pupil on the cross-hair target in the middle of the image. The chin rest control on the instrument is also available to move the chin rest.

### Test Pattern

To the right of the Live Eye monitor is the test pattern with labeled meridians and radii.

### Stimulus Value

A maximum of 10 different types of stimuli can be used per test. Each stimulus type is identified by a unique icon. When three or more meridian points with the same stimulus parameters are completed, isopter lines will automatically be drawn connecting the points.

The **Stimulus Value** shows the icon and stimuli that have been used during the test. Select a stimulus at any time during the test by touching:

- **New** button at the top of the list, *or*
- A stimulus already used in the test and displayed in the legend.

Selecting **New** to set a new stimulus type opens a window with all the selection parameters, including color, size, intensity, and intensity modifier. Default values are highlighted in blue. Parameter values for size, intensity, and intensity modifier correspond to standard Goldmann values.

• Select new parameters, then **OK** to accept and close the window. The new Stimulus Value will now be displayed in the stimulus value legend on the **TEST** screen.

Select **Cancel** to return to the **test screen** without choosing a stimulus.

Color	Size	Intensity	Intensity Modifier
White	I	1	a
Red	II	2	a'
Blue	III	3	b
	IV	4	b'
	V		c
			c'
			d
			d'
			e
			e'

### Stimulus Speed

The **Speed** drop-down menu sets the speed in degrees per second ( $^{\circ}/\text{sec}$ ), at which the stimulus moves in the test bowl. Touch or click to open the menu and select the setting from the following options:(The default value ( $5^{\circ}/\text{sec}$ ) is bold.)

- $2^{\circ}/\text{sec}$
- $3^{\circ}/\text{sec}$
- $4^{\circ}/\text{sec}$
- **$5^{\circ}/\text{sec}$**
- $10^{\circ}/\text{sec}$

### Visual Field Size

To choose the visual field size, use the sliding bar located in the bottom right of the screen. The default size is 90 degrees ( $90^{\circ}$ ), peripherally. If only the central visual field is being tested choose 30 degrees ( $30^{\circ}$ ). If testing within the central 30 degrees and you choose to use a trial lens, it is suggested you use manual trial lenses, not the Liquid Trial Lens.

### Test Mode

Touch on a selection to change from one test mode to another:

- Meridian
- Point to Point
- Static Point
- Blind Spot Map

Test modes are described in following sections.

### Grid Menu

The Grid drop-down menu is available with Meridian, Point to Point, and Static Point, and allows several grid resolution settings:(The default value ( $5^{\circ}$ ) is bold.)

- $1^{\circ}$
- **$5^{\circ}$**
- $10^{\circ}$
- $15^{\circ}$

### Note

See feature “[Note,](#)” on page 4-4.

### Delete Point

To delete any test point, select the point to highlight it (the point will turn green) and select **Delete**.



Note: If two test responses overlap during kinetic testing, you will be unable to retest or delete the first point tested.

### Isopter Lines

Isopter lines are drawn on the screen to connect three or more points of the same stimulus type.

aaa, aaa  
Female ID 1812151178 Date of birth 3/13/1954 64 years  
Manual Kinetic 5/21/2018 5:07 PM OD

Meridian 45 Radius 50 Speed 5"/sec

Stimulus Value  
New

Speed  
5"/sec

90°

Cancel Pause

### Meridian Mode

While the **Meridian** test mode is selected, perform the following steps to present a stimulus to the patient:

1. Select a stimulus type from the stimulus legend or choose a **New** stimulus.
2. Touch the screen or depress the mouse on a point anywhere on the test pattern. The Meridian and Radius values of the point are displayed above the test pattern.
3. While mouse is left-clicked, or with finger on screen, move finger or mouse to any location. The Meridian and Radius values update above the test pattern, and a vector line with an arrow is drawn from the point to the center. If the radius position is outside the testable area, the point will automatically be placed at the maximum position.
4. Lift finger or release the mouse to fix the point.
5. The stimulus immediately begins to move down the line to the center.
6. The point along the line at which the patient responds is displayed by an icon.

aaa, aaa  
Female ID 1812151178 Date of birth 3/13/1954 64 years  
Manual Kinetic 5/21/2018 3:33 PM OD

Meridian 40 Radius 40 Speed 5"/sec

Stimulus Value  
New

Speed  
5"/sec

90°

Cancel Pause

### Point to Point Mode

While the **Point to Point** test mode is selected, perform the following steps to present a stimulus to the patient:

1. Select a stimulus type from the stimulus legend or choose a **New** stimulus.
2. Touch screen, or click mouse, to place the first point anywhere on the test pattern. If the radius position is outside the testable area, the point will automatically be placed at the maximum position.
3. Lift finger or release the mouse to fix the point.
4. Touch the screen, or click mouse, to place the second point anywhere.
5. A vector line with an arrow is drawn between the two points and is updated as the finger or mouse moves the position of the second point.
6. Lift finger or release the mouse to select the second point.
7. The stimulus immediately starts to move between the two points.
8. The point along the line at which the patient responds is displayed by an icon.



### Static Point Mode

While the **Static Point** test mode is selected, perform the following steps to present a stimulus to the patient:

1. Select a stimulus type from the stimulus legend or choose a **New** stimulus.
2. Touch screen, or click mouse, to place a point anywhere on the test pattern. If the point is outside the testable area, it will automatically be placed at the maximum position.
3. Move finger, or depress the mouse, to reposition the point. Meridian and Radius values are updated.
4. Lift finger, or release mouse, to place stimulus.
5. Stimulus begins immediately and shines in place for 0.5 seconds.
6. If the patient sees the stimulus, a gridded icon is displayed. If the stimulus is not seen, an X is drawn over the gridded icon.

The Speed drop-down menu is unavailable while in Static Point mode.



**Note:** To retest a point where a response was already made, touch or left-click on another area of the screen and move finger or mouse to the point. Direct selection of the point will highlight it for deletion. The HFA3 will only display the retested point once.

### Blind Spot Map Mode

When **Blind Spot Map** is selected, the Grid drop-down menu becomes the Pattern drop-down menu, the visual field automatically zooms to 30 degrees (30°), stimulus speed is automatically set to 2 degrees (2°)/sec (speed), and the scan radius is set to 10 degrees (10°). Speed and Field size settings cannot be changed.

1. Choose from a 4, 6, or 8 meridian pattern, with 6 as the default.
 

**Note:** Each meridian of the 4 meridian pattern is separated by 90 degrees (90°), the meridians in the 6 pattern by 60 degrees (60°), and the meridians in the 8 pattern by 45 degrees (45°).
2. Select a stimulus type from the stimulus legend or choose a **New** stimulus.
3. Touch screen, or click mouse, to place a point anywhere in the white-shaded region on the test pattern. The stimulus can extend outside the white area.
4. Lift finger or release the mouse to fix the point.
5. The stimulus immediately begins to move from the center, along the line, and stops when the patient responds.



**Note:** Standard coordinates for the average anatomical blind spot are: X = 15 degrees (15°), Y = -1 degree (-1°).

### Pause or Cancel the Test

Whether the test is paused or running, select **Cancel** to access several options:

- Cancel Current Eye Test and Test Next Eye (results are not saved)
- Cancel Entire Test (results are not saved)
- Return to Current Eye Test

Select **Pause** to pause the test. This will be indicated on the screen. Select **Restart Test** to delete the results and restart the test. Select **Return to Test** to go back to the **Test** screen.

### End the First Test

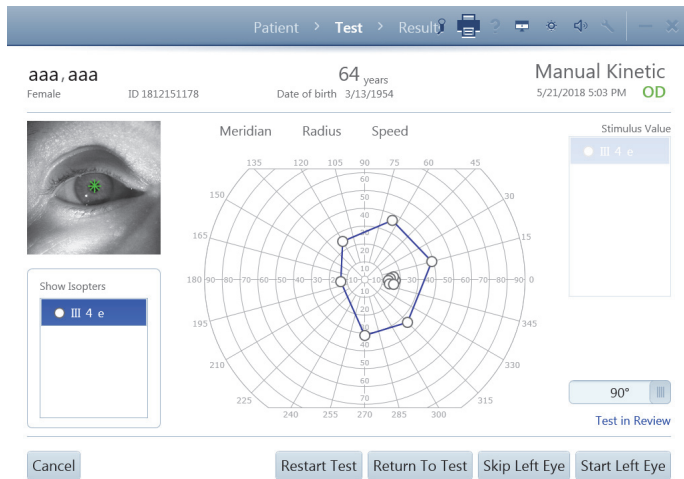

Select **Review Results** to end the first test (if both eyes are being tested). In the next screen:

- Show or hide the connecting isopter lines for each stimulus by selecting or deselecting the stimulus in the **Show Isopters** menu.
- Select **Start (Other) Eye** to start testing for the other eye. Test data for the first eye will be locally saved.
- Select **Skip (Other) Eye** to go directly to the **Results** screen. The skipped eye will not be shown.
- Select **Restart Test** to delete the results and test the first eye again. Confirm your choice.
- Select **Return to Test** to go back to testing.
- Select **Cancel** for cancellation options.

### Test the Second Eye

The **Test** screen displays for the second eye. Set up the patient and test the second eye following the same procedures used for the first eye.

When the second eye is complete, select **Review Results**. From the next screen, show or hide isopters, cancel the test, restart the test, return to testing, or end the test.



Note: To cancel the entire test, manually delete the results from the first eye. See [“Delete Tests,”](#) on page 6-4 to do this on the instrument. If the instrument is set up to export data to FORUM, manually export data to the server (**Settings > Network > Manual data export**), and delete the exam from FORUM. Results from the first eye should also be manually exported if the second eye exam fails.

### Final Results

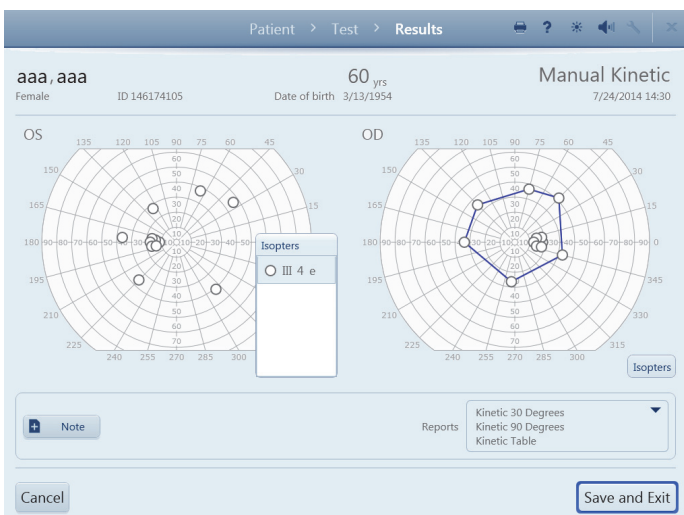

Select **End Test** for the final review of both eyes before saving. In the **Results** screen:

- To view isopters select **Isopters** to expand the **Isopters** box for each eye. Show or hide the connecting isopter lines for each stimulus by selecting or deselecting the stimulus. Tap the top of the Isopters box again to close the box.
- Add **Note** to the test if desired.
- Select or deselect report formats from the Reports drop-down list.
- Select **Cancel** for cancellation options.
- Select **Save** and **Exit** to complete the test. Selected reports will be printed and/or exported automatically.

### Preset Kinetic Tests

Preset Kinetic test patterns can be run on the HFA3. An example of a preset test pattern is the authorized Social Security Administration (SSA) test. To create a test pattern, refer to [“Create Kinetic Test Pattern,”](#) on page 4-23.

Stimulus Value, Speed, and Visual Field settings cannot be altered during the test. SSA test parameters are III 4 e (size and intensity), 4 degrees (4°)/sec (speed), White (color).



Note: Select **Cancel** at any time to cancel test results.

#### To run a preset Kinetic Test:

1. In the **Patient screen**, go to **Test Parameters** and choose an available preset test pattern from the **Test Pattern** drop-down menu.
2. Press **Next**. The Kinetic **Test** screen displays the Live Eye monitor and the test pattern with preset test points.
3. Choose between two test modes:
  - Select **Automatic** to run all of the test points automatically.
  - Select **Step by Step** to run each stimulus one at a time.



Note: If desired, switch between **Automatic** and **Step by Step** at any time during the test or when the test is paused.

#### Automatic Mode

- A. Select **Start Test**.
- B. Each stimulus will automatically move along the line to the center. Coordinates are displayed above the test pattern.
- C. Select **Pause** to stop the test and choose from the following options:
  - Select **Restart Test** to delete current test responses and restart the test. Confirm or cancel this selection.
  - Select **Return to Test** to continue with the test.

#### Step by Step Mode

- A. Select **Start Test** to test the first point. The **Pause** option is available while the test is running.
  - B. Select **Test Next Point** to test each additional point. The **Restart Test** option is also available.
4. During testing, **Points Completed** is continuously updated and isopter lines are drawn between completed points. **Total Points** are also shown.
  5. Retest a point by selecting an already tested stimulus, then select **Retest Point**. This option is available only after all points are tested.



Note: A message will display at the end of testing if points were missed during the test (no response made). The option to retest the points will be provided.

6. Select **Review Results** when testing is complete to test the other eye.

#### Note

See the feature “[Note](#),” on page 4-4.

#### Review Results

Same as Manual Kinetic “[Final Results](#),” on page 4-20.

## Create Custom Test Patterns

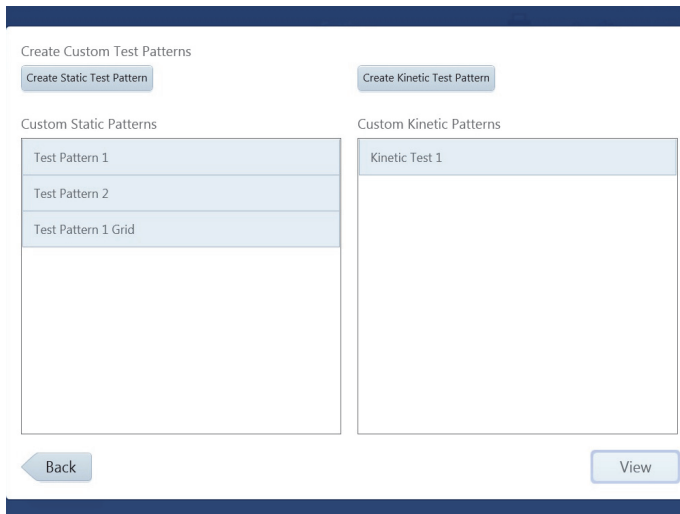

To create a custom pattern:

1. Go to **Settings**  > **Specific Settings** > **Custom Test Patterns**. You should see a list of patterns if any exist.
2. To view a pattern, highlight it and select **View**. To create a new pattern, select **Create Static Test Pattern** or **Create Kinetic Test Pattern**.

**Note:** A custom Static Test Pattern can be used as either a Threshold or Suprathreshold test.

**Note:** The SITA test strategy cannot be used in a custom test.

### Create Static Test Pattern

After **Create Static Test Pattern** is chosen, a message displays stating that the pattern created will specify the right eye (OD). A mirror image of the pattern will be created for the left eye (OS). Select **OK**.

The next screen displays the following features:

- **Test Field** - Create test points by directly touching or clicking on the test field. X, Y values are displayed to the right.
- **Test Pattern** - Select either Single or Grid to create single points or a grid pattern, respectively. Single points can be added to a Grid Point Pattern and a grid of points can be added to a Single Point Pattern. A test pattern can hold a maximum of 248 points.
- **Field Size** - Changes the field view display. This has no effect on the pattern itself, but point placement is easier in the central portions of the field of view by selecting 10 degrees (10°) or 30 degrees (30°). 90 degrees (90°) displays the entire field in degrees.
- **Point Spacing** - This option is only available when the Grid test pattern is selected and is the distance allowed between points (Two, Four, Six, Eight, Ten, Twelve degrees).
- **Delete Point** - Touch or click on a point to highlight it (the point will turn blue) and delete by selecting **Delete Point**.

Create Custom Static Test Pattern

OD

N T

X Value 8  
Y Value -16

Delete Point

Test Pattern Single

Field Size 30 Degrees

Back Save

### Create a Single Point Pattern

Set the Test Pattern to **Single**. Create single points by touching the test pattern on the screen directly, or by using a mouse.

1. Move your finger or the mouse, while holding the mouse button down, to position the point at the desired X, Y value.
2. Release your finger from the screen or mouse button to fix the point.

**Note:** The newest point created will be highlighted in blue.

3. Select **Save** when all the points have been created.
4. Confirm that you have entered all the points for the test.
5. Place cursor in the text box and enter a name for the pattern.
6. Select **Save** to save the pattern. Select **Cancel** to cancel the pattern.

### Create a Grid Point Pattern

Set the Test Pattern to **Grid**:

1. Position the first point with your finger or mouse and release, as described in "Create a Single Point Pattern," on page 4-23.

2. Position and fix the second point. A grid of evenly spaced points will be created between the two points. X, Y values of the **Top Left** and **Bottom Right** points in the grid are displayed.

3. When the pattern is complete, select **Save**.

**Note:** Highlighting one of the grid points will display its X, Y values under **Top Left**.

4. Confirm that you have entered all the points for the test.
5. Place cursor in the text box and enter a name for the pattern.
6. Select **Save** to save the pattern. Select **Cancel** to cancel the pattern.

The created pattern is now displayed in **Custom Static Patterns**, as well as the Test Patterns drop-down menu located under Test Parameters on the **Patient** screen and located under **Test Profiles** in "Specific Settings," on page 3-13.

### Create Kinetic Test Pattern

1. Select **Create Kinetic Test Pattern**. A message displays stating that the pattern created will specify the right eye (OD). A mirror image of the pattern will be created for the left eye (OS).
2. Select **OK**.
3. Select **Yes** to randomize the order of the meridians for presentation of stimuli. Select **No** to maintain the order in which the meridians were entered.
4. Choose and add stimuli to the test pattern in the **Create Custom Kinetic Test Pattern** screen. This screen has the same functionality as the **Manual Kinetic Test** screen. See "Administer the Test (Manual Kinetic)," on page 4-16.
5. Select **Save**.
6. Select **Yes** if all points have been entered. Select **No** to return to the **Create Custom Kinetic Test Pattern** screen.
7. Enter a name for the Custom Test Pattern and select **Save**.

The created pattern is now displayed in **Custom Kinetic Patterns**, as well as the Test Patterns drop-down menu located under Test Parameters on the **Patient** screen and located under **Test Profiles** in "Specific Settings," on page 3-13.

## Set up Test Profiles

Test Profiles comes with a standard set of tests. Test profiles can be modified or deleted except for the 24-2 SITA Standard test and the default test.

The screenshot shows the 'Create New Test Profile' screen. At the top, there is a 'Create New Test Profile' button and a search bar containing '24-2, SITA Standard' with a 'Make Default' button to its right. Below this is a list of test profiles on the left, with '24-2, SITA Standard' highlighted. The main area contains a list of settings for the selected profile, each with a dropdown menu: Test Type (Threshold), Test Pattern (Central 24-2), Test Strategy (SITA-Standard), Blue-Yellow (Off), Stimulus Color (White), Stimulus Size (III), Fixation Monitoring (Gaze / Blind Spot), Fixation Target (Central), and Test Speed (Normal). At the bottom, there are 'Back' and 'Save' buttons.

To create a new test profile:

1. Go to **Settings**  > **Specific Settings** > **Test Profiles** > **Create New Test Profile**.

2. Choose the desired test parameters by using the drop-down menus. See [Appendix \(A\), "Test Patterns & Parameters"](#), for further details about test parameter settings.

**Note:** Once a specific test type is selected from the Test Type drop-down menu, the screen automatically displays only the options that are available for that test type.

3. Select the Reports desired for the new test profile.

4. Enter a name and select **Save** to add the new test profile to the list located on the left-hand side of the screen.



**Note:** To make a test the default, highlight the test name and select **Make Default**. This test will now be automatically selected when a new patient is created.

The test is now accessible from the Test Profile menu on the **Patient** screen.

## Delete Test Profiles and Patterns

To delete a custom test profile or test pattern:

1. Go to **Settings**  > **Specific Settings** > **Test Profiles** *or* **Custom Test Patterns**.

2. Hold down on the test profile or pattern to be deleted and wait for a circle to be drawn around your finger. Release your finger to bring up a pop-up menu. Select **Delete**.

*or*

Right-click on the test profile with a mouse to bring up the pop-up menu. Select **Delete**.

3. A message will appear to confirm your deletion. Select **Yes** or **No**.

## (5) Quick Reference Guide

This section is a quick reference guide for the Humphrey® Field Analyzer 3 (HFA™3).



**CAUTION:** Refer to the **Instructions for Use** for warnings, cautions, safety information, labeling, and detailed operating instructions. The quick guide is only a complement to the Instructions for Use.



### Start Up



1. Switch the power on by pressing the On/Off button.
2. Select Continue to proceed or Details for further information.
3. Enter user name and password.

### Prepare for Testing

Select Patient

Step	Returning Patient	New Patient
1	Select the search field to display the cursor. The search field is indicated by the icon 	Select the <b>Add</b> button.
2	Type a few letters or numbers of any of the following: Last or First Name, ID Number, Date of Birth (DOB). Select the  button to initiate the search.	Fill in the required entries: Last name, First name, ID Number, Gender, and Date of Birth (DOB).
3	Highlight the name in the search results to select the patient from the resulting list.	Patient age will appear once DOB has been entered.

### Input Refractive Correction and Trial Lens Values

Step	Returning Patient	New Patient
1	The Distance Prescription and Trial Lens values are retrieved from the last test.	Enter the Distance Prescription values manually.
2	If needed, change any value by touching the value box, use the  icon to delete the value, and type a new value. Press <b>Enter</b> to accept the value and move cursor to the next value box. The Trial Lens/AutoTLC value is automatically calculated based on the Distance Prescription and the patient's age.	The Trial Lens/AutoTLC value is automatically calculated based on the Distance Prescription and the patient's age.
3	If needed, manually override the Trial Lens value by typing in the desired value, which will then be displayed in blue font.	

### Test Setup

1. For an existing patient the previous test that was used will automatically display. Otherwise, the 24-2 SITA FASTER is the default test.
2. If needed, select a different test from the Test Profile menu. The new test profile, pattern, and strategy now displays.
3. If a specific test is not in the Test Profile menu, swipe down on the page and use the Test Parameters menu to select new test parameters.

4. Use the **Perform test on** drop-down menu to select which eye to test: **OD** (right), **OS** (left) or **Both**. Default is both.
5. To add notes select **Add Note**.
6. Change the default Reports by selecting or deselecting one or more **Reports** from the drop-down menu.
7. Enter IOP (intraocular pressure) and Visual Acuity if desired.
8. Confirm test information and select the **Next** button to proceed.

### Trial Lens Setup

The Auto Trial Lens Correction (AutoTLC) automatically adjusts the spherical correction to the Trial Lens value. This feature is only available on Model 860.

For all other models insert manual trial lens into the holder:

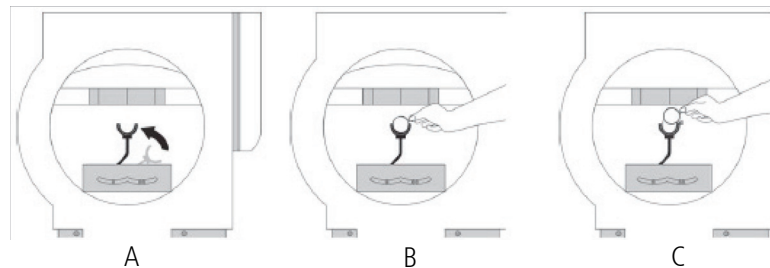

1. Move the trial lens holder into an upright position from its storage position in the bottom of the bowl (A).
2. Place the spherical lens in the slot closest to the patient and the handle to the right for the OD eye and to the left for the OS eye (B).



- Place the cylinder lens, if indicated, in the slot farthest away from the patient and align the axis (C).

**Patient Setup**

- Occlude the non-test eye.
- Position the patient. Patients are most comfortable if sitting more or less erect.
- Instruct the patient using the instructions shown on the screen.

Place chin on the appropriate side of the chin rest.

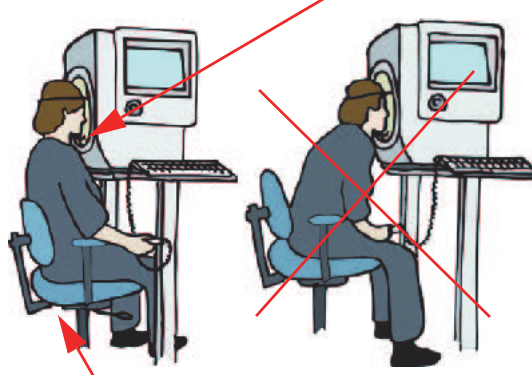

Move chair close to the instrument.

Heijl, A., Patella, V.M., and Bengtsson, B. (2012) Effective Perimetry, Fourth Edition. Carl Zeiss Meditec, Inc.

- Touch the center of the pupil, indicated by a red X when not centered to the lens, in the Live Eye monitor, or use the manual chin rest switch, to move the chin rest and align the eye to the center of the lens target, indicated by a green plus sign. Pupil is correctly centered to the lens when the plus sign (+) and the x sign (x) overlap to form a green star (✱).
- The **Back** button returns to the previous screen. Select **Next** to proceed.



## Preliminary Tests (Optional)

### Perform Foveal Threshold (if selected)

1. Read the on-screen instructions to the patient.
2. Select **Start Foveal Threshold**.
3. To proceed without this test select **Skip Foveal Threshold**.

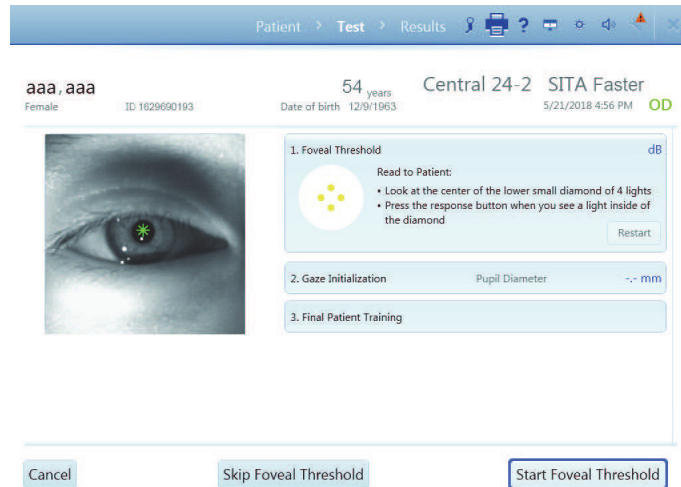

### Perform Gaze Initialization (if selected)

1. Make sure to adjust the eye position before you initialize.
2. Read the on-screen instructions to the patient.
3. Select **Start Gaze Initialization**.
4. To proceed without this test select **Skip Gaze Initialization**.
5. If Gaze Initialization fails a pop-up message provides available options.

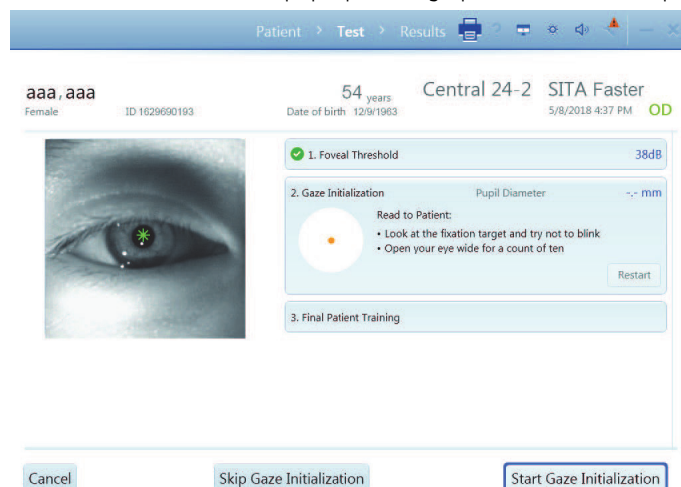

### Perform the Test

1. Read the **Final Patient Training Instructions** to the patient.
2. Select **Start Test** to initiate the visual field test.
3. To cancel the test select **Cancel**.

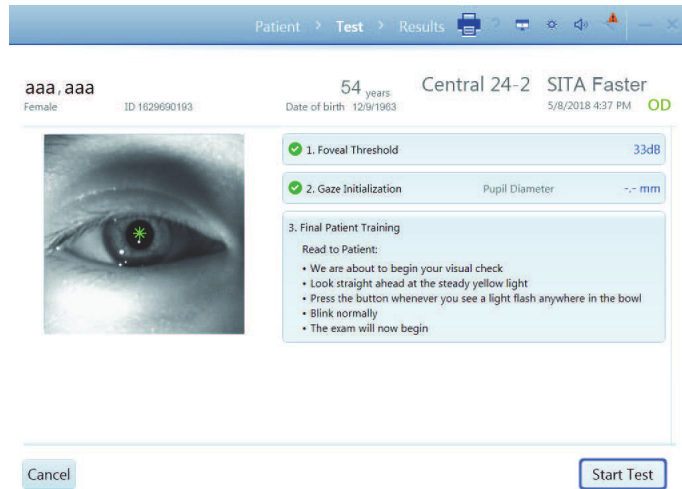

### Monitor the Test

Screen features:

- The Live Eye monitor allows you to center the eye by touching the eye image, or you can use the chin rest direction controls on the instrument to manually move the chin rest. It is recommended to leave the function Head Tracking ON and let the machine center.
- The progress bar displays patient responses, as well as gaze errors when Gaze Tracking is active.
- The test pattern displays closed test points in either gray scale or numerical values.
- Reliability indices are shown in the upper right of the screen.

1. When the test for the eye is complete, a message displays. Select OK.
2. Test the second eye following the same procedure.

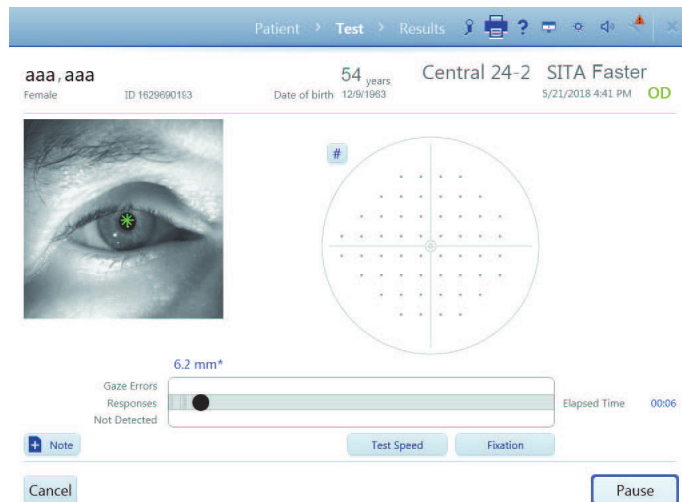

## Review and Save Results

**Review Results** displays the test results for each eye tested. You can:

- Use Add Note to add comments to the exam.
- Change the output of Reports.
- Select Save and Exit. A confirmation message will display when exam data is saved.

1. Selected Reports will be automatically printed and/or exported based on the configurations set for the instrument.
2. The instrument returns to the PATIENT screen.

Patient > Test > Results

aaa, aaa 54 yrs Central 24-2 SITA-Faster  
Female ID 1629680193 Date of birth 12/9/1963 7/24/2014 13:56

Eye	Blind Spot Errors	False Positive	False Negative	Total Time
OS	12/15 XX	2 %	5 %	04:54
OD	1/13	0 %	0 %	04:24

Add Note Reports GPA Summary SFA

Cancel Save and exit

**Cancel** the entire exam (both tests) if you need to delete both test results and start again.

## (6) Data, Tests & Reports

See the [Instrument Settings](#) section starting on page 3-10 to set up your instrument to backup, archive, retrieve, and restore data.



**CAUTION: Routinely back up your data in case it becomes lost or damaged.**

To manage data, tests, and print reports in FORUM for a FORUM connected instrument see the user guides for FORUM and FORUM Glaucoma Workplace. To connect the HFA3 to FORUM or EMR systems, see [Chapter \(7\), "Networking"](#). To use the instrument in local database mode, disable DICOM network (**Settings > Network**), and turn off EMR Mode (**Settings > Specific settings > Non DICOM EMR Settings**), and the settings under DICOM Output (**Settings > Specific settings > Report Output**).

### Save Test Reports and Test Data

The naming convention for test reports is:

Last Name\_Test Date\_Test Time\_Eye (OD or OS)\_HFA serial number\_Report code\_Patient ID.

See [Table 6-1](#), [Table 6-4](#), and [Table 6-5](#) for the report codes.

### FORUM Connected Mode

When the HFA3 is connected to FORUM, test data are automatically exported to the server archive if data export has been enabled (FORUM Test Database setting **On** under the **Report Output** settings). If the connection fails, data are saved to the instrument and export continues once the connection is re-established. If the operating mode has been changed from local database mode to FORUM mode, transfer locally stored data to the server archive by selecting the **Manual data export** button under settings in "[Networking](#)," on page 3-19. Once records are transferred to FORUM, local data will be deleted.

### Local Database and EMR Connected Modes

For instruments in local database mode or connected to a DICOM compatible or non-DICOM EMR system, data are saved automatically to the HFA3. Reports selected on the Patient screen are automatically printed and/or exported at the end of testing to the storage location configured using the settings under **Report Output** or **Printout**. Report types for saving and printing from a patient test list can be selected under **Default Reports** (see "[Specific Settings](#)," on page 3-13).

To automatically export test reports to a DICOM compatible or non-DICOM EMR system, use the procedures in [Chapter \(7\), "Networking"](#). If the connection fails to a DICOM compatible EMR, export will continue once the connection is re-established.

### Export Tests Manually

To manually export test data to a shared network folder or USB storage device, use the following procedure.



Note: You cannot use this procedure if data export to FORUM has been enabled (FORUM Test Database setting **On** under the **Report Output** settings).

Tests

aaa, aaa ID 146174105 60 yrs  
Female Date of birth 3/13/1954

Select one or more tests to include in referral. Total Selected: 0

Date	Time	Eye	Parameters
7/25/2014	10:58	OS	SITA-Standard Central 24-2, W-W III Threshold Test
7/25/2014	10:57	OD	SITA-Standard Central 24-2, W-W III Threshold Test
7/25/2014	10:29	OS	Two Zone Central 76 Point, W-W III Suprathreshold Test
7/25/2014	10:28	OD	Two Zone Central 76 Point, W-W III Suprathreshold Test
7/25/2014	09:44	OS	SITA-Standard Central 24-2, W-W III Threshold Test
7/25/2014	09:43	OD	SITA-Standard Central 24-2, W-W III Threshold Test
7/24/2014	14:43	OS	SITA-Standard Central 24-2, W-W III Threshold Test
7/24/2014	14:42	OD	SITA-Standard Central 24-2, W-W III Threshold Test
7/24/2014	14:39	OD	SSA-W Kinetic Test
7/24/2014	14:30	OS	Manual Kinetic-W Kinetic Test
7/24/2014	14:28	OD	Manual Kinetic-W Kinetic Test
7/24/2014	14:09	OS	SITA-Standard Central 24-2, W-W III Threshold Test
7/24/2014	14:08	OD	SITA-Standard Central 24-2, W-W III Threshold Test
7/24/2014	13:56	OS	SITA-Standard Central 24-2, W-W III Threshold Test
7/24/2014	13:45	OD	SITA-Standard Central 24-2, W-W III Threshold Test

Back Delete Select All Clear Selection Save To

1. Select the **Tests** button at the bottom of the **Patient** screen. (see page 1).

2. In the **Tests** screen:

- Highlight individual tests to select a limited number of tests to export, OR choose **Select All** to export all of the tests.
- Choose **Clear Selection** to clear your choice.
- Select **Save To** (choose between Save to HFA3 Format or Save to HFAII-i Format) and save selected tests to a USB device or network location. A data transfer summary screen will appear with details of the export process.

### Save Reports Manually

You can use the following procedure to save test reports to a USB storage device, network shared folder, or an EMR system. You cannot use this procedure if FORUM data export has been enabled.

Reports

Patient 1, HFA3 ID 1629690193 54 years  
Female Date of birth 12/9/1963

Select one or more tests to generate reports... Total Selected: 2

Date	Time	Eye	Parameters	GPA Reliability
5/10/2018	10:56 AM	OS	SITA Faster Central 24-2, W-W III ThresholdTest	
5/10/2018	10:56 AM	OD	SITA Faster Central 24-2, W-W III ThresholdTest	
5/10/2018	8:27 AM	OS	SITA Faster Central 24-2, W-W III ThresholdTest	
5/10/2018	8:26 AM	OD	SITA Faster Central 24-2, W-W III ThresholdTest	
5/1/2018	11:29 AM	OS	SITA Faster Central 24-2, W-W III ThresholdTest	
5/1/2018	11:28 AM	OD	SITA Faster Central 24-2, W-W III ThresholdTest	
12/9/2016	3:37 PM	OD	Two Zone Peripheral 60 Point, W-W III SuprathresholdTest	
12/9/2016	3:35 PM	OS	Quantify Defects Full Field 81 Point, W-W III SuprathresholdTest	
12/9/2016	3:32 PM	OS	Two Zone Central 40 Point, W-W III SuprathresholdTest	
12/9/2016	3:29 PM	OS	Full Threshold Central 24-2, R-W IV ThresholdTest	
12/9/2016	3:27 PM	OD	Full Threshold Central 10-2, B-Y V ThresholdTest	
12/9/2016	3:25 PM	OS	Fastpac Central 10-2, W-W IV ThresholdTest	
12/9/2016	3:19 PM	OD	Fastpac Central 30-2, B-W III ThresholdTest	

Back Select Reports Clear Selection Save

1. Select the **Reports** button at the bottom of the **Patient** screen.

2. In the following screen, tests for the patient will be listed. Highlight one or more tests.

3. Select **Save** (local database mode), **DICOM EPDF** (for a DICOM EMR).

4. If you selected **Save**, select/confirm the export location in the next screen. Choose **Select** if exporting to a mapped shared folder or USB.

5. A progress screen will appear, followed by a message stating export results.

Options from here are:

**Select Reports** - change the selection of default report types you wish to save for the selected tests.

**Clear Selection** - clears the highlighted tests.

Reports

**Patient 1, HFA3**

Female ID 1629690193

54 years

Date of birth 12/9/1963

GPA Summary ▾ SFA SFA Overview GPA Last Three Follow Up ▾ Full GPA ▾ SFA GPA ▾ Three In One

Select one or more tests to generate reports... Total Selected: 2

Date	Time	Eye	Parameters	GPA Reliability
5/10/2018	10:56 AM	OS	SITA Faster Central 24-2, W-W III ThresholdTest	
5/10/2018	10:56 AM	OD	SITA Faster Central 24-2, W-W III ThresholdTest	
5/10/2018	8:27 AM	OS	SITA Faster Central 24-2, W-W III ThresholdTest	
5/10/2018	8:26 AM	OD	SITA Faster Central 24-2, W-W III ThresholdTest	
5/1/2018	11:29 AM	OS	SITA Faster Central 24-2, W-W III ThresholdTest	
5/1/2018	11:28 AM	OD	SITA Faster Central 24-2, W-W III ThresholdTest	
12/9/2016	3:37 PM	OD	Two Zone Peripheral 60 Point, W-W III SuprathresholdTest	
12/9/2016	3:35 PM	OS	Quantify Defects Full Field 81 Point, W-W III SuprathresholdTest	
12/9/2016	3:32 PM	OS	Two Zone Central 40 Point, W-W III SuprathresholdTest	
12/9/2016	3:29 PM	OS	Full Threshold Central 24-2, R-W IV ThresholdTest	
12/9/2016	3:27 PM	OD	Full Threshold Central 10-2, B-Y V ThresholdTest	
12/9/2016	3:25 PM	OS	Fastpac Central 10-2, W-W IV ThresholdTest	
12/9/2016	3:19 PM	OD	Fastpac Central 30-2, B-W III ThresholdTest	

Back

Select Reports

Clear Selection

Print

Save

DICOM EPDF

Save ▾

Settings Option	Description
Reports	The list shows tests sorted on Date, Time, Eye, and Parameters GPA Reliability. Click in the row to highlight a test. You can select one or more tests to generate reports.
Select Reports	Once the desired tests are highlighted, click on <b>Select Reports</b> . A menu appears at the top with the following choices (the choices vary depending on the kind of tests that were created): <ul style="list-style-type: none"> <li>GPA-Qualified</li> <li>SFA-Qualified</li> <li>Kinetic Tests</li> </ul>
Clear Selection	Clear the selection.
Save	Save selected reports. Click on the drop-down menu and choose the format to save selected reports. Format choices: <ul style="list-style-type: none"> <li>Print</li> <li>Save</li> <li>DICOM EPDF</li> </ul>
Back	Go back to the previous screen.

## Print Test Reports

Reports selected on the **Patient Test** selection screen are automatically printed at the end of testing. When a report is chosen at the **Patient Test** selection screen, report(s) will be automatically generated at the end of the test and automatically sent to the configured output location. There is no need to take any other action to generate the report at the end of a test.

For instruments connected to FORUM, you can print reports from FORUM. For other modes, reports will be printed to a printer connected to your instrument.



Note: If the FORUM connection is lost, print reports by switching the instrument to local database mode. Go to **Settings > Network** and disable DICOM network. Make sure you have a printer connected to the instrument.

To manually print to a connected printer:

1. In the Reports screen switch the **Save** button to **Print** by touching or clicking the down arrow and selecting **Print** from the drop-down menu.
2. Touch or click on the **Print** button to print the reports.
3. A progress screen will appear, followed by a message that the print process is completed.



Note: The progress screen and print complete message still appear if the printer is disconnected or turned off. When the printer is connected or turned back on, the queued reports will print. Select the printer icon displayed at the top of the screen to display the status of the print job. Selecting the **Cancel** button in the Print dialog box will not cancel the print job.

## Reassign Tests

If the wrong patient was selected at the beginning of a test, the test results can be reassigned to the correct patient. This function is only available if the FORUM test database is not enabled in **Specific settings > Report Output**.

1. In the **Patient screen**, select the name of the patient that was incorrectly associated with the test. Click the drop-down menu arrow to the right of the patient name, then select **Tests** from the menu.
2. Select the test to be reassigned, then click **Reassign**.
3. Use the search field to find the patient the test should be reassigned to.
4. Select the patient and click **Next**.
5. Enter a reason for moving the test and click **Next**. To set a default reason, select the **Use this text as default reassign reason** check-box before clicking **Next**.
6. Confirm that the correct test is being reassigned to the correct patient, and select **Reassign Test**.

## Delete Tests

Tests can be deleted on the instrument if the FORUM test database is not enabled in **Specific settings > Report Output**:

1. Select the **Tests** button on the **Patient screen**.
2. In the Tests screen highlight the test or tests that need to be deleted.
3. Select **Delete** and confirm to delete the highlighted tests.

If data are exported to FORUM, delete tests from the archive. Tests are automatically deleted from the instrument once they have been exported.



## Import Tests

Test data cannot be directly imported from a DICOM/EMR system to the instrument.

### Manually Import Tests

1. Connect a USB storage device containing the data you want transferred to a USB port on the HFA3 (see [Figure 3-5](#)). Data can also be imported from a shared network folder.
2. Go to **Settings**  > **Specific settings** and select **Import**.
3. In the Import screen, select **Import...** to add the tests on the storage device to the HFA3 database.

**Note:** There is no way to see or choose the tests to be imported.

For instruments connected to a DICOM compatible or non-DICOM EMR system, local data on the instrument are retained. You must manually export/import data to/from an external location to keep multiple instruments synchronized. See “[Confirm or Change Patient Information](#),” on page 4-2 for more information about how patient records are reconciled.

## View and Generate Test Reports

Data analysis and report generation must be conducted directly in FORUM for instruments exporting data to FORUM.

### Manually Generate Reports

When connected to an EMR system, conduct all data analysis on the instrument. Reports generated using the following procedure can only be printed to a connected printer, or exported to a USB storage device or shared network folder:

1. Highlight a patient and select the **Reports** button at the bottom of the **Patient** screen.
2. In the following screen, tests for the patient will be listed displaying Date, Time, Eye, Parameters, View, and GPA Reliability.
3. To view reports available for a specific test, select a test on the list.
4. A list of report types that are available for that test will appear at the top of the screen.
5. Highlight a report type. The selected report will be displayed on the screen.  
**Note:** To see the available tests, select the arrow down for the report type. If no selection is made the default selection is automatically assigned.
6. If more than one test is required for the report (like GPA and SFA Overview), the next screen displays a list of qualified tests. Confirm or change which tests are included in the analysis.  
**Note:** GPA tests will display an automatic selection of qualified Baseline tests and Follow-up tests. Always review the Baseline and Follow-up test selections before performing a GPA analysis. To change the selection, deselect tests and then reselect tests to include in the analysis. Follow-up tests cannot pre-date Baseline tests. See “[GPA Analysis](#),” on page 6-14 for more details. Select **Next**.
7. The **Report** screen displays the report format, viewing magnification options, and printer selection at the top of the page.
8. Select **Back** to go back to the previous screen or select **Print** to print the report. The **Print** button can be changed to **Save** or **Save and print** by selecting the down arrow and bringing up the drop-down menu. Reports will be saved/printed in PDF format only.

## Merging and Deleting Patient Records

If the HFA3 is connected to an EMR system, patients merged or deleted on the HFA3 are only merged locally; the records on the EMR remain unchanged. If the HFA3 is connected to FORUM, patients cannot be merged or deleted from the local system because the patient database is stored in the FORUM archive. Patient reconciliation must be done in FORUM or the leading system.

### Merge Patients on the HFA3

You may merge up to 20 names into one patient file.

Last Name	First Name	Patients ID	Date of Birth	Gender	
aa	a	1417685561	3/13/1954	Female	Compare
aaa	a	1417685507	7/24/1954	Female	Compare
aaa	a	1417685529	3/13/1954	Female	Compare

At the bottom of the screen are 'Back' and 'Merge' buttons.

1. In the **Patient screen**, select the patient, then click the drop-down menu arrow to the right of the patient name. Select **Merge**.

2. In the Merge patient data screen, enter search terms to find patient records.

3. Highlight the records of interest from the resulting list. Select **Compare** to display comparisons of each record with the patient record shown at the top of the screen. Original patient record will be displayed on the right.

4. Select **Merge** at the bottom of the screen to merge the highlighted records with the original patient record.

5. Enter a reason for merging patient data and select **Merge** again.

Where there are conflicts between an imported patient record and a local record, the local record is overwritten.

### Delete Patients on the HFA3

1. In the Patient screen, select the patient, then click the drop-down menu arrow to the right of the patient name. Select **Delete**.

2. Select **Delete** again to confirm.

## Static Threshold Reports

The HFA statistical software, STATPAC, provides data analysis that is included on most Threshold report formats. STATPAC analysis is available for central field tests using the Size III, White stimulus only. Guided Progression Analysis (GPA) helps identify progressive visual field loss in patients and is available for Central 24-2 and Central 30-2 using the SITA Faster, SITA Fast, SITA-Standard, and Full Threshold tests. Report examples and brief descriptions of report features are provided in the following sections.

Report (Code)	Description
Single Field Analysis (SFA)	SFA analyzes the results of a single threshold test and provides the most information for a given test. SFA is available for all central test patterns regardless of test strategy.
SFA Overview (OVR)	An overview report presents the results of up to sixteen (16) SFA tests for comparison.

Table 6-1 List of Static Threshold Reports

Report (Code)	Description
Full GPA (GPA)	GPA assists with detection of glaucoma progression. Full GPA is a multi-page overview of the patient's entire history.
GPA Summary (GPASUM)	Short GPA report (one page).
GPA Last Three Follow Up (GPAL3F)	Follows the same format as the Full GPA, but includes only the three most recent Follow Up tests.
SFA GPA (SFAGPA)	SFA GPA is an SFA report that incorporates a GPA Progression Analysis Probability Plot.
Three In One (3N1)	The Three In One report includes a gray-tone, numeric, and defect depth presentation of the results of a single test on one page, and is available for all Threshold tests except custom and SITA-SWAP tests.
Numeric (NUM)	The Numeric Report is available for custom threshold tests and displays raw data in table format.

**Table 6-1** List of Static Threshold Reports

### **The SFA and SFA GPA Report**

The SFA report displays patient data, test reliability indices, and test results in Grayscale and Numeric formats. STATPAC analysis is found in the lower half of the page and includes the Total Deviation Plot, the Pattern Deviation Plot, Glaucoma Hemifield Test (GHT), Visual Field Index (VFI), Mean Deviation (MD), and Pattern Standard Deviation (PSD) values. For details see ["Report Features,"](#) on page 6-12.

The SFA GPA report also includes GPA results in the GPA information box ([Figure 6.1](#)). The GPA information box contains the Progression Analysis Probability Plot for the current test, test dates for the GPA Baseline tests and the two previous Follow-up tests, and the GPA Alert. See ["Numerical and Graphical GPA Plots,"](#) on page 6-13 for further details.

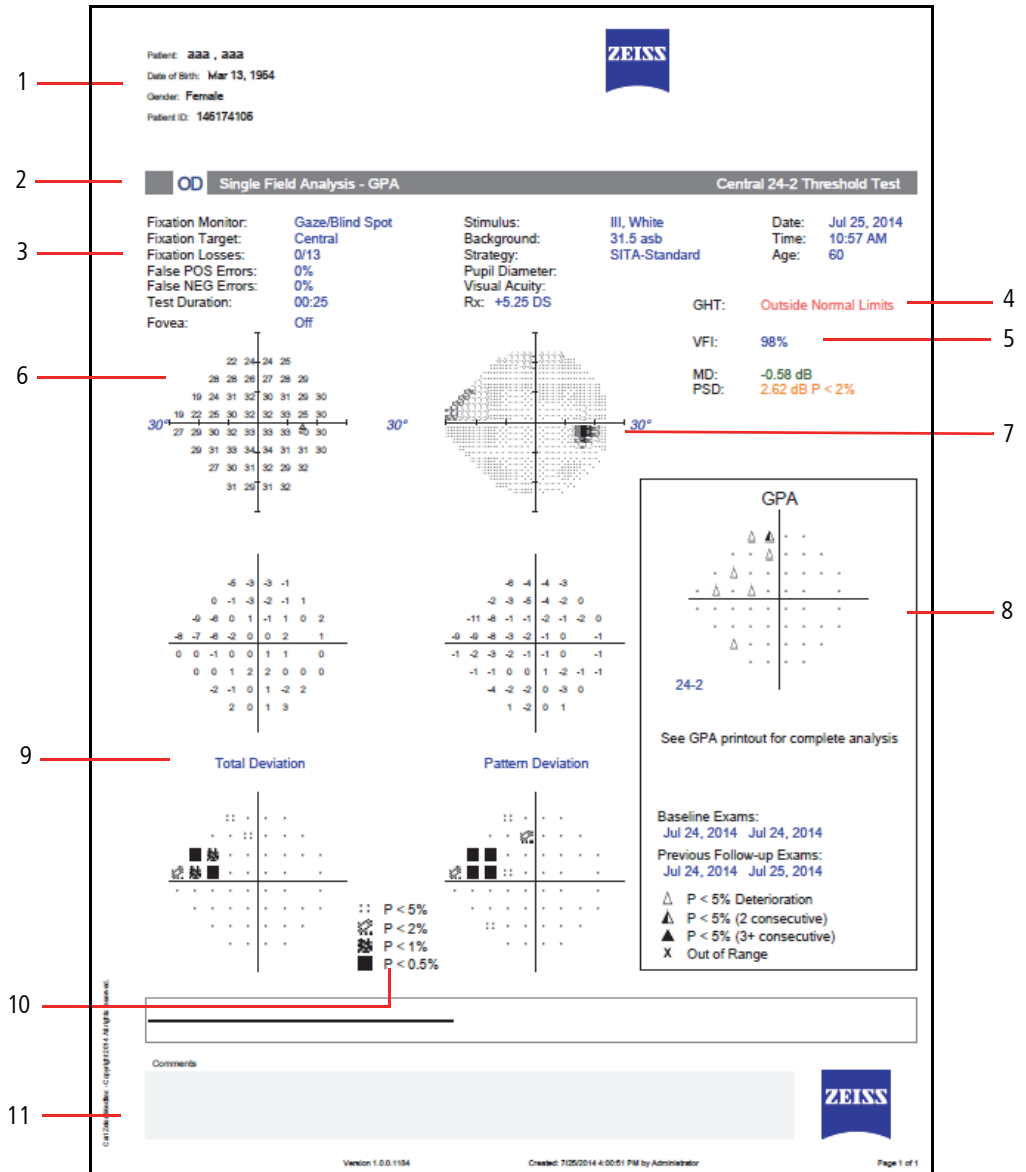

Figure 6.1 Single Field Analysis with GPA (SFA GPA)

- 1 – Patient Data
- 2 – Test and Report Type
- 3 – Reliability Indices
- 4 – Glaucoma Hemifield Test
- 5 – Global Indices
- 6 – Numeric (dB) Results
- 7 – Grayscale Results
- 8 – GPA Information
- 9 – Deviation Plots
- 10 – Probability Symbols
- 11 – Notes Field

**The SFA Overview Report**

The Overview report shows the results of multiple tests in chronological order. Results from 30-2 and 24-2 tests may be presented in the same report.

The results of each test display Grayscale, Numeric, Total Deviation, and Pattern Deviation Plots, along with test date, GHT, and indices. If available, visual acuity and pupil size are located at the upper right of each Pattern Deviation Plot.

Overview reports are available for non-STATPAC 24-2, 30-2, 10-2, and SWAP tests. No probability plots are available. You cannot mix tests run with different stimulus sizes or colors.

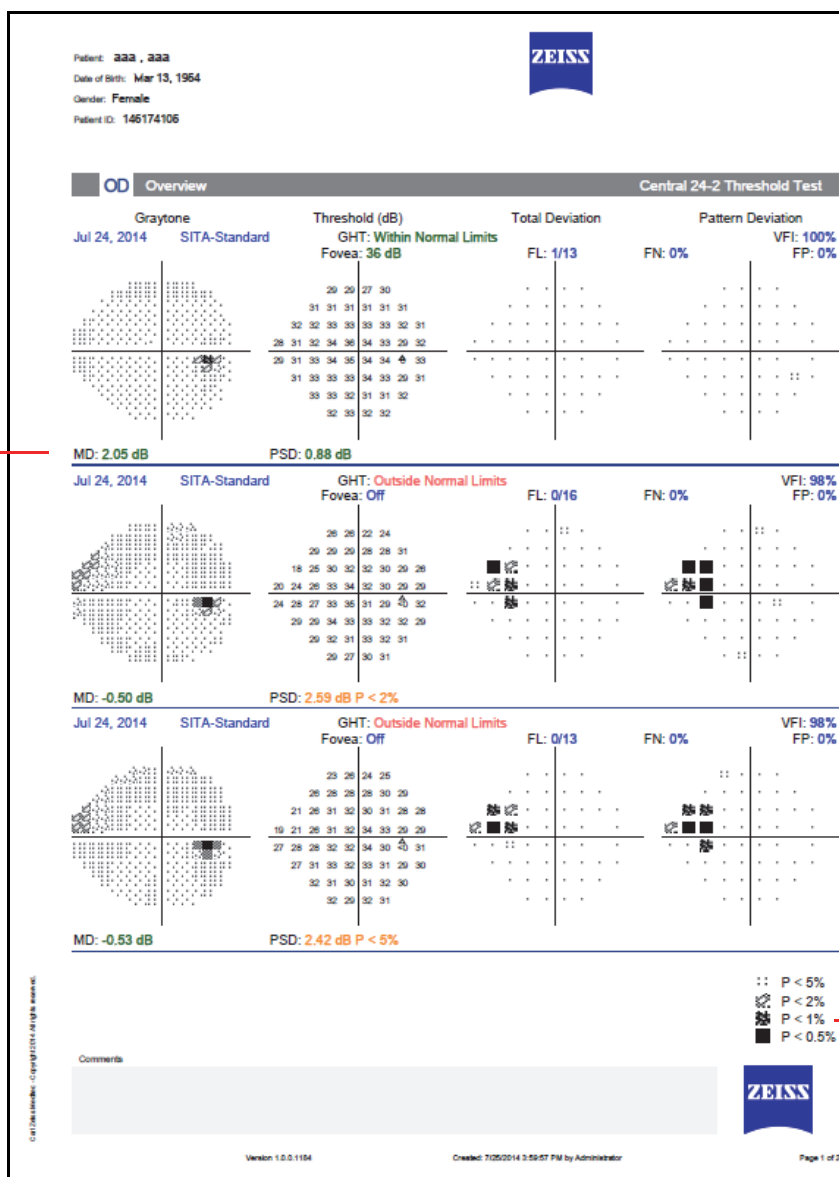

Figure 6.2 SFA Overview

- 1 – VFI
- 2 – Reliability Indices
- 3 – Global Indices
- 4 – Probability Symbols

**GPA Summary Report**

The GPA Summary report is a one-page report that provides an overview of the patient’s qualified visual field history. At the top of the report, Grayscale and Pattern Deviation Plots are shown for both GPA Baseline tests, along with key indices. The VFI Plot and VFI Bar are located in the center of the page. Results for the current visual field test are shown at the bottom of the report, including the Grayscale, Pattern Deviation, Deviation from Baseline, and the Progression Analysis Probability Plots. The GPA Alert will appear here as well.

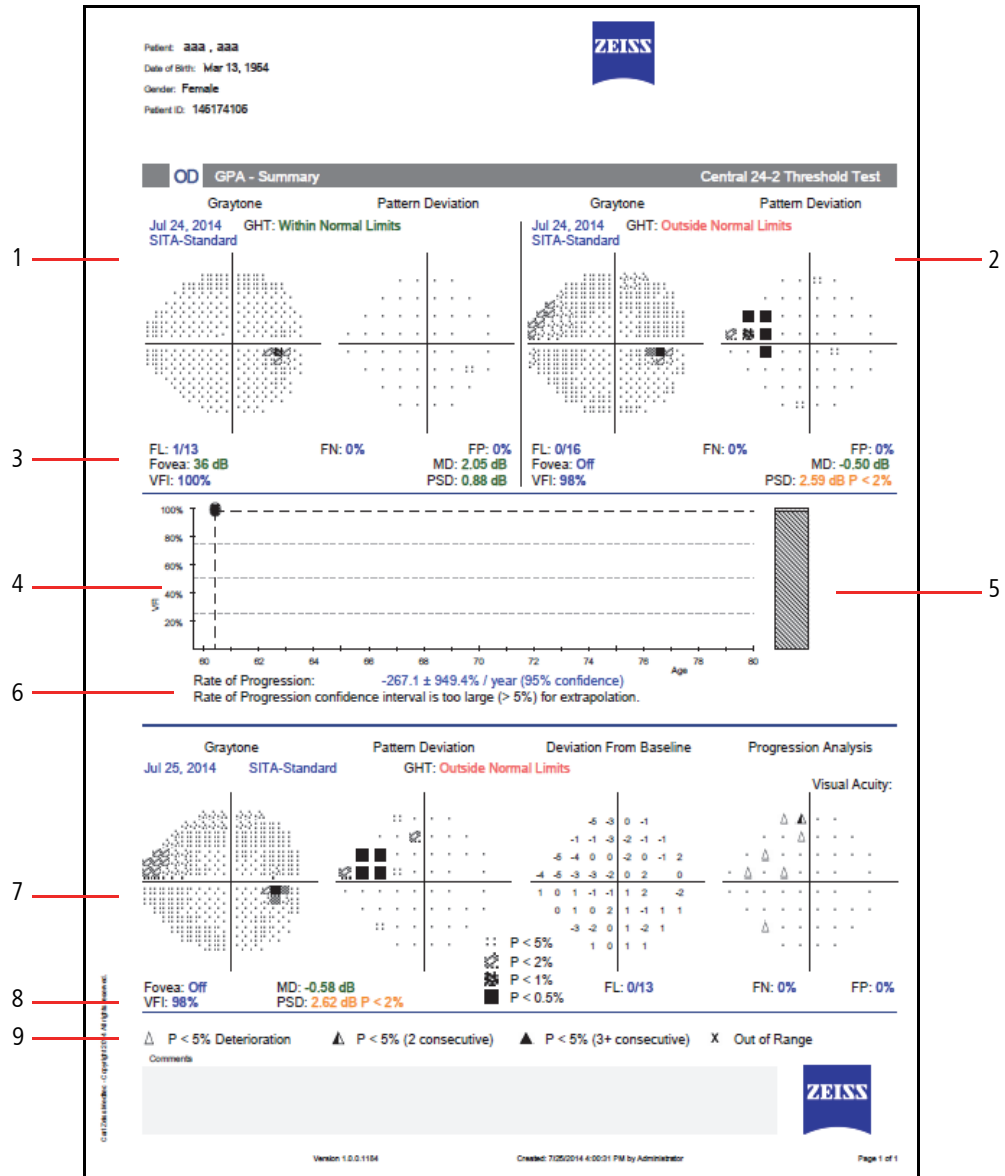

Figure 6.3 GPA Summary

- 1 – Baseline 1
- 2 – Baseline 2
- 3 – Indices
- 4 – VFI Plot
- 5 – VFI Bar
- 6 – VFI Linear Regression Analysis
- 7 – Current Test
- 8 – VFI Value
- 9 – Progression Analysis Symbols

### Full GPA and Last Three Follow Up Reports

The Full GPA report is a multi-page overview of the patient's entire history. The Baseline page provides Grayscale, Numeric, Total Deviation, and Pattern Deviation Plots, as well as key indices for both GPA Baseline tests. The VFI Plot and Bar are displayed at the bottom. Subsequent pages show three Follow-up tests per page in the format: Grayscale, Pattern Deviation, Deviation from Baseline, Progression Analysis, key indices, and the GPA alert. The GPA Last Three Follow Up Report follows the same format, but includes only the three most recent Follow-up tests.

### Three in One Report

If threshold test patterns or test parameters do **not** meet the criteria for STATPAC analysis, results are presented in Grayscale, Numeric, and Defect Depth formats on the Three in One report. The numbers that appear outside each quadrant of the numeric grid are called quad totals and represent a summation of the threshold values determined in each quadrant. This format is available for 10-2, 24-2, 30-2 central field tests, and for the peripheral 60-4 test. The nasal step Three in One test report displays only threshold and defect depth data.

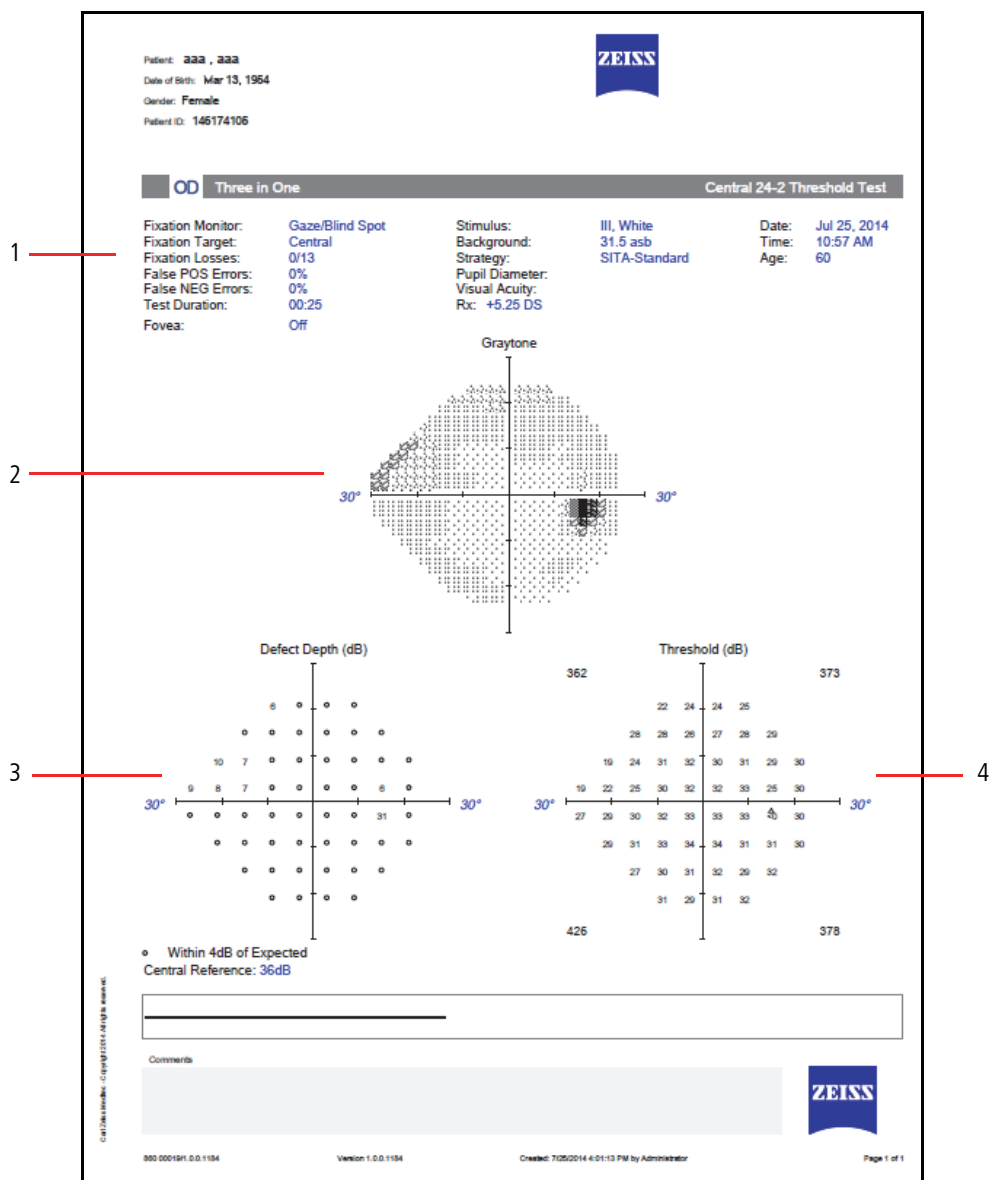

Figure 6.4 Three In One

- 1 – Reliability Indices  
 2 – Grayscale Results  
 3 – Defect Depth  
 4 – Numeric (dB) Results

## Report Features

### Reliability Indices

#### Blind Spot Errors (Fixation Losses/FL)

Blind Spot Errors are recorded when Blind Spot monitoring is active and occur when a patient responds to a stimulus presented in the blind spot. The number of responses is recorded over the total number of stimuli presented. A high error rate may mean poor patient fixation during the test or that the blind spot was located incorrectly. Fixation Losses  $\geq 20\%$  are indicated by a double X.

#### False Positives (FP)

False Positive errors occur when a patient responds too quickly to a stimulus or in the absence of a stimulus. In SITA tests False Positives are not calculated until the end of the test and a percentage  $\geq 15\%$  will be indicated by a double X. A percentage  $\geq 33\%$  will be indicated for non-SITA tests. A high score suggests that the patient may be overly concerned about not seeing all the stimuli. Patients that respond inappropriately may also have abnormally high threshold results.

#### False Negatives (FN)

A False Negative is recorded if the patient does not respond when a stimulus is repeated at a particular location and at a level much brighter than has already been seen.



Note: Reports will display only one message with the priority given to high False Positives and the message "Excessive High False Positives". Otherwise, the message "Low Test Reliability" is displayed on SITA test reports if Fixation Losses are  $\geq 20\%$ . For non-SITA tests, the same message will display if either the number of Fixation Losses are  $\geq 20\%$  or False Negatives are  $\geq 33\%$ .

### Grayscale and Numeric Formats

The Grayscale format depicts the size and depth of any present field defects. Each pattern variation corresponds to a 5 dB change in sensitivity. The comparative scale in Table 4-2 displays the ten (10) Grayscale patterns and relates them to decibels and apostilbs.

SYM										
ASB	0.8–0.1	2.5–1	8–3.2	25–10	79–32	251–100	794–316	2512–1000	7943–3162	> 10000
DB	41–50	36–40	31–35	26–30	21–25	16–20	11–15	6–10	1–5	$\leq 0$

Table 6-2 Grayscale Symbols and Numerical Equivalents in Apostilbs (ASB) and Decibels (dB).



Note: The Grayscale in SWAP printouts often looks significantly darker because SWAP testing normally generates lower threshold sensitivity values than does white-on-white testing. The maximum (0 dB) stimulus in SWAP testing is 6 foot-lamberts, not 10,000 apostilbs.

### Total Deviation Plots

The numeric values in the upper total deviation plot represents the difference in decibels (dB) between the patient's test results and the age-corrected normal values at each tested point.

The lower total deviation plot, called a probability plot, translates the values from the upper plot into shaded symbols indicating the highlights points falling below specific percentile levels



compared to the reference limits. These are explained in the legend labeled “Probability Symbols.” For instance, a totally black square indicates that the value observed at that point location occurred in less than 0.5% of the subjects in the reference database.

### Pattern Deviation Plots

The Pattern Deviation plots are similar to the total deviation plots, except that STATPAC has adjusted the analysis of the test results for any changes in the height of the measured hill of vision caused, for example, by cataracts or small pupils. STATPAC also corrects for any patients who are “supernormal.”

### Global Indices

**Visual Field Index (VFI):** VFI is a weighted average of the ratio of the measured threshold to the age-adjusted normal threshold for all points that have depressions in the Pattern Deviation at the 5% level or higher. The VFI is weighted to give increased importance to thresholds near the point of fixation.

**Mean Deviation (MD):** MD is the average elevation or depression of the patient’s overall field compared to the normal reference field. “P” values are given to significant deviations.

**Pattern Standard Deviation (PSD):** PSD is a measurement of the degree to which the shape of the patient’s measured field departs from the normal, age-corrected reference field. “P” values are given to significant deviations.

**Short term fluctuation (SF):** SF is used with Full Threshold and FastPac™ tests. When fluctuation is turned on, the threshold is measured twice at 10 preselected points. The HFA then calculates a fluctuation value on the basis of the differences between the first and second measurements at each of the 10 points.

**Corrected Pattern Standard Deviation (CPSD):** CPSD is PSD corrected for intra-test variability (SF) and is used with Full Threshold and FastPac tests only.

### The Glaucoma Hemifield Test

For 24-2 and 30-2 tests, the GHT evaluates five zones in the superior field and compares these zones to their mirrored zones in the inferior field. One of these messages will be displayed: WITHIN NORMAL LIMITS, OUTSIDE NORMAL LIMITS, or BORDERLINE. The message GENERAL REDUCTION OF SENSITIVITY is shown whenever the field is depressed to a level seen in fewer than 0.5% of the normal population in the patient’s age range. When the comparison indicates abnormally high sensitivity, the message ABNORMALLY HIGH SENSITIVITY appears.



Note: The GHT is not available with FastPac tests.

### Numerical and Graphical GPA Plots

#### Deviation from Baseline Plot

The Deviation from Baseline Plot compares the pattern deviation of a Follow-up test to the average of the pattern deviation values of two Baseline tests, and indicates changes at each tested point. See [Figure 6.3](#).

### Progression Analysis Probability Plots

The Progression Analysis Probability Plot compares the changes between the Baseline and Follow-up tests and highlights points that have worsened by an amount that exceeds the variability in all but the most variable 5% of glaucoma patients in a reference population.

- A single, solid dot • indicates a point not changing by an amount that exceeds the test-retest variability observed in a reference population.
- A small open triangle  $\triangle$  identifies a degree of deterioration expected less than 5% of the time at that location in a reference population of stable glaucoma patients; that is, deterioration at the 5% level ( $p < 0.05$ ). This symbol is used when the change was not seen on a previous Follow-up test.
- A half-filled triangle  $\blacktriangle$  identifies a point changing by an amount that is worse than all but the most variable 5% of glaucoma subjects in a reference population and that is repeated in two consecutive Follow-up tests.
- A solid triangle  $\blacktriangle$  identifies a point changing by an amount that is worse than all but the most variable 5% of glaucoma subjects in a reference population and that is repeated in three consecutive Follow-up tests.
- An **X** signifies that the data at that point was out of range for analysis.



Note: Pattern Deviation plots and GPA Progression Analysis Probability plots are not shown for severely depressed visual fields (MD less than or equal to 20 dB).

### VFI Plot

The VFI Plot graphs the VFI values of all tests included in GPA analysis as a function of the patient's age, and provides a linear regression analysis of the VFI over time (5 tests over 3 years or more are required). VFI values from Full Threshold tests are represented by open squares, and VFI values from SITA tests are represented by filled squares.

To the right of the VFI Plot is the VFI Bar, indicating the patient's current VFI value. The VFI Bar will graphically indicate the 3 to 5 year projection of the linear regression line, shown as a broken line. The length of projection is equal to the number of years of GPA data available, up to a maximum of 5 years.



Note: GPA reports also include the GPA Alert. In cases where 3 or more points show deterioration in at least 2 consecutive tests, the progression analysis indicates "Possible Progression." In cases where 3 or more points show deterioration in at least 3 consecutive tests, the progression analysis indicates "Likely Progression." When neither of the foregoing conditions applies, a message of "No Progression Detected" is displayed.

### GPA Analysis

Only SITA tests may be chosen initially for GPA analysis. You may mix any combination of SITA-Standard, SITA-Fast or SITA Faster tests to create a GPA analysis. The HFA3 will automatically choose the two oldest compatible tests to be the Baseline. Tests displaying high False Positives  $\geq 15\%$  are excluded by default from GPA analysis. You can manually change the default Baseline tests or exclude specific tests.



Note: Manual Baseline selections may override automatic selection of the two oldest compatible tests. Always review the Baseline and Follow-up test selections before performing a GPA analysis. If the Baseline tests are Full Threshold, then the Follow-up tests may be any combination of SITA Faster, SITA Fast, SITA-Standard, or Full Threshold. If the Baseline tests are any SITA test, then Full Threshold are not allowed as Follow-up tests.

### Suprathreshold Reports

The Suprathreshold test strategy determines the type of responses that are displayed on the report (Table 4-3). See “Suprathreshold Test Settings,” on page A-9 for more details on Suprathreshold test strategies.

Strategy	Response	Format
Two Zone	Point Seen	O
	Point Not Seen	■
Three Zone	Point Seen	O
	Relative Defects	X
	Absolute Defects	■
Quantify Defects	Point Seen	O
	Depth of Defect	Numbers in dB (the larger the number the greater the defect)

**Table 6-3 Test Response Formats**

Suprathreshold reports are listed in Table 4-4.

Report (Code)	Description
Suprathreshold (SCR)	Report that displays a single eye. Two page reports, one displaying the full field and one displaying the central 30 degrees, are generated for the following test patterns performed using the Quantify Defects strategy: <ul style="list-style-type: none"> <li>• Armaly Full Field</li> <li>• Full Field 81 Point</li> <li>• Full Field 120 Point</li> <li>• Full Field 135 Point</li> <li>• Full Field 246 Point</li> </ul>
Suprathreshold OU (SC_OU)	Report that displays both eyes (does not include full field patterns). This report is available for the following test patterns: <ul style="list-style-type: none"> <li>• Central 40 Point</li> <li>• Central 64 Point</li> <li>• Central 76 Point</li> <li>• Central 80 Point</li> <li>• Armaly Central</li> <li>• Peripheral 60 Point</li> </ul>

**Table 6-4 List of Suprathreshold Reports**

The type of test and test parameters are printed at the top of the report along with the patient data, test date and test time (Figure 6.5). Suprathreshold reports include the reliability indices (see “Reliability Indices,” on page 6-12).

When a Suprathreshold test uses the Threshold Related testing mode, the central (and peripheral) reference level values are determined from patient responses and appear on the report. The central reference level is the calculated threshold at the fovea. When the Age Corrected mode is used, the central (and peripheral) reference levels display values based on the patient's age.

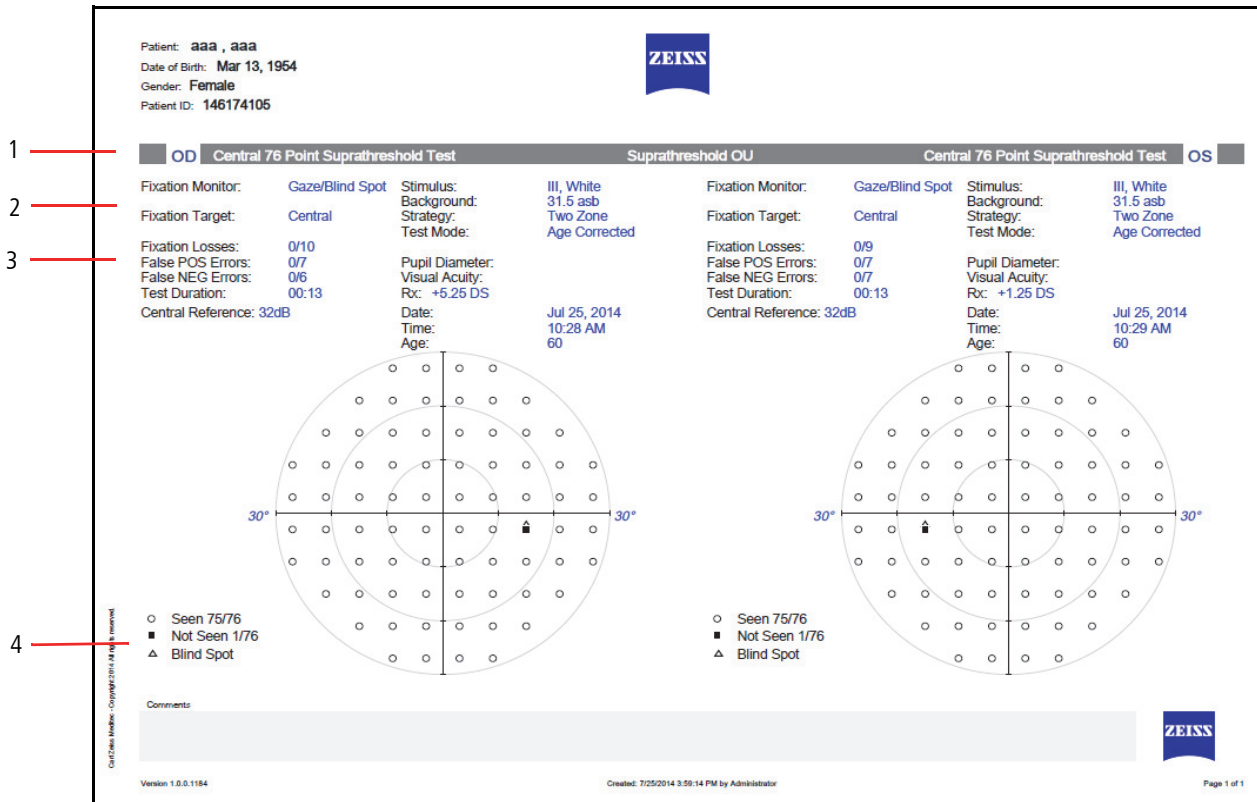

Figure 6.5 Suprathreshold OU Report

1 – Eye/Test/Report

2 – Test Details

3 – Reliability Indices

4 – Response Symbols

### Kinetic Reports

Report	Description
Kinetic 30 Degrees (KIN30)	Report for a central visual field test.
Kinetic 90 Degrees (KIN90)	Report for a full visual field test.
Kinetic Table (KINTBL)	Report that displays the locations of the starting and ending points of all stimuli presented during the kinetic test. The table also lists all Static Points and whether each point was seen or not.

Table 6-5 List of Kinetic Reports

### Kinetic 90 Degrees Report

The Kinetic full field report shows all isopters mapped out to the periphery. Some points may be hidden if they are too close together, as is likely in the central 30 degrees of the full field. The 30 degree view will display the hidden points.

Isopter points are connected to form the isopter lines. However, points that define the borders of a blind spot are not connected to each other. Occasionally an isopter point will appear on the report that is not connected to other isopter points. This situation occurs when you have retested a meridian. Only the most recent point on a meridian will be used for the isopter map.

Isopters

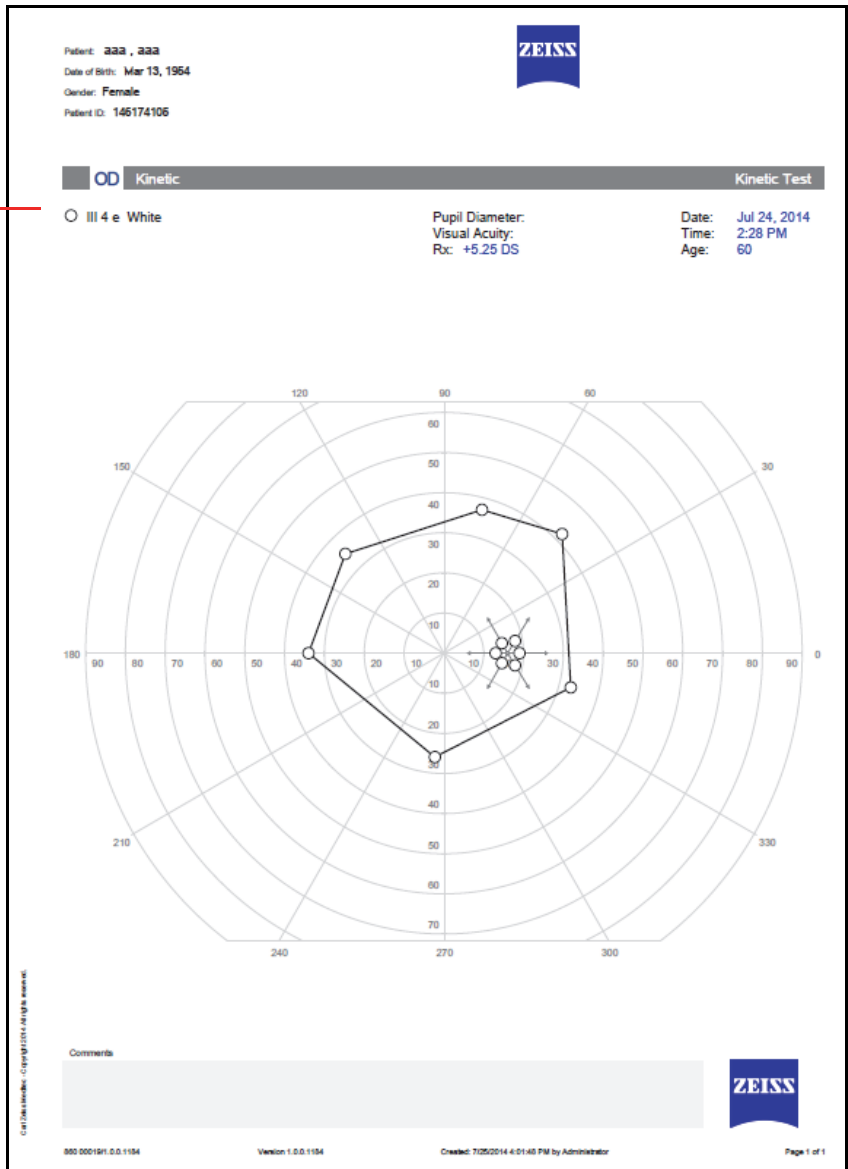

Figure 6.6 Kinetic 90 Degrees



## (7) Networking

This chapter contains instructions for:

- Networking the HFA3.
- Connecting and exporting to a shared network folder (page 7-2).
- Connecting the HFA3 instrument to FORUM (page 7-4).
- Connecting the HFA3 to a DICOM compatible EMR system (page 7-5).
- Connecting the HFA3 to a non-DICOM EMR system (page 7-5).
- Configuring the instrument to use a printer.

You must log in as a user with Administrator privileges to access network settings.



Note: Users are responsible for network setup and maintenance, including installation and configuration of all necessary hardware and software. ZEISS Customer Support is limited to testing network connectivity of the instrument. Customer Support cannot troubleshoot or repair problems with network connectivity.



Note: Consult an IT, System, or DICOM/EMR network administrator for help in entering correct configuration information. For assistance in the U.S., call ZEISS at 800-341-6968. Outside the U.S., contact a local ZEISS distributor.

### Network Capabilities

The HFA3 instrument can connect to local area networks for data storage using an Ethernet port. Enable the DICOM network setting to connect to ZEISS' FORUM or other DICOM/EMR systems.



Note: To use the instrument in local database mode, make sure that all DICOM/EMR settings are off. The HFA3 supports the following:

- Store exams and reports to FORUM, or a LAN (Local Area Network).
- Store test reports to DICOM compatible and non-DICOM EMR systems.
- Import patient scheduling and demographic information from a DICOM Modality worklist or non-DICOM EMR system.
- Print to PostScript network printers, wireless printers (via a wireless USB adapter) and PostScript printers that are directly wired to the HFA3.





Note: The HFA3 supports Internet Protocol Version 4 (TCP/IPv4), but not IPv6.

## Configuration to Pre-existing Office Network

This section explains how to configure the HFA3 to communicate via a pre-existing office network (LAN). To do this, the instrument must be connected to the office network by a standard network patch cable. Make sure to plug one end of your standard network patch cable into the HFA3 Ethernet port (see [Figure 3-5](#)). Be sure to handle the cable connector gently. It is the user's responsibility to install the necessary cables.

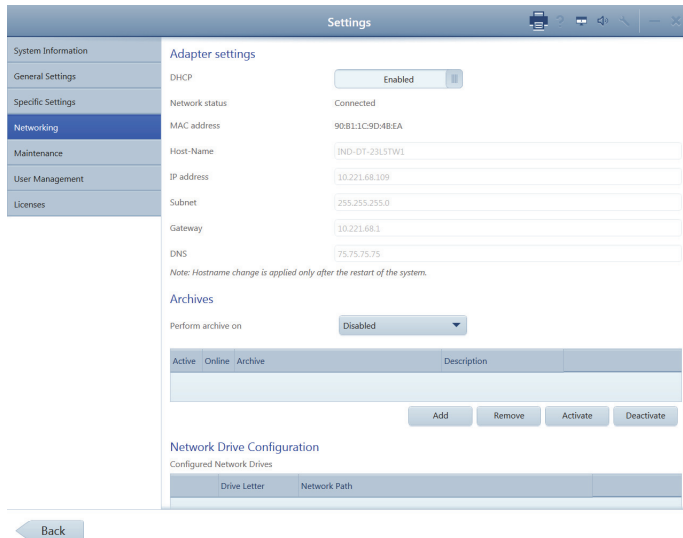
### Configure Networking Settings on the HFA3



1. Start the instrument and log in as an Administrator user. If the instrument is already on, you may log in as another user by selecting **Change user** from the **Close** button menu while in the PATIENT screen.
2. Select **Settings**  > **Networking** to display the **Networking** screen.
3. Ensure that **DHCP** (Dynamic Host Configuration Protocol) is **Enabled** to automatically assign an IP address to the instrument.
4. If the network uses static IP addresses, contact a network administrator to have the HFA3 added, or set DHCP to **Disabled** and fill in the IP Address, Subnet Mask, and Default Gateway fields.

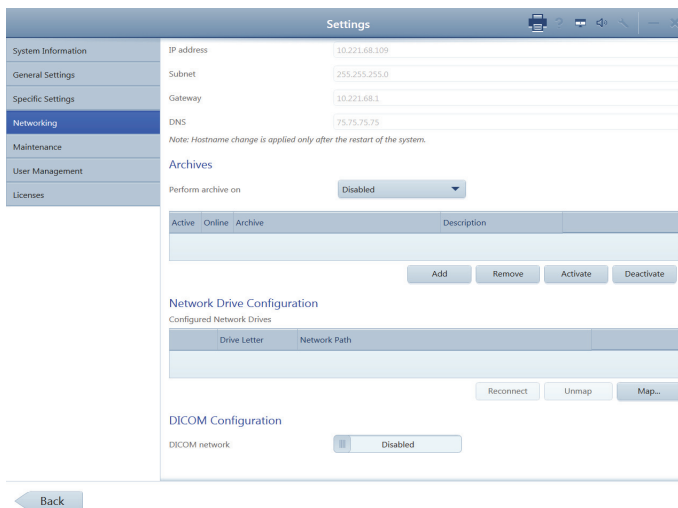

### Add Network Shared Folders



1. Make sure you are logged in as an Administrator user.
2. In the **Networking** screen select **Map network drive** under **Network drive configuration**.
3. Perform the following steps in the resulting dialog window:
4. In **Network path**, enter the **network shared folder address**. **Note:** You may only map a shared folder where the target is a root directory, or a subdirectory owned by a root directory. Attempting to map lower level folders will result in a user name and password error message. You can navigate to lower level folders to save reports using the **Printout** and **Report Output** settings. See ["Instrument Settings,"](#) on page 3-10.
5. Select an unused drive letter.
6. Enter **User name** and **Password** for the shared folder. Do not enter either if no password is required.
7. Select **Map**.
8. You will return to the **Networking** screen. Make sure that the mapped drive appears under **Available network drives**.



### Export to a Network Shared Folder

1. Select **Settings**  > **Specific Settings** to display the Specific Settings screen (see [page 13](#)).
2. Select **Report Output**.
3. In the **End of Test Settings** screen, under **Report Output Default**, select **Print**, **Export**, or **Export and Print**.
4. Under **Report Export File Type** select file types.
5. Report **Export Location** lists the current export location. Select the triple dot  button to change the export location from the **Select folder screen**:
  - A. Choose the **left folder icon** to navigate to the shared network folder. Select the mapped folder.
  - B. Choose the **right folder icon** to add a folder to the selected export location.
  - C. Choose **Select**.
6. You will return to the **End of Test Settings** screen.

### Patient Folders

You may also automatically create patient folders while exporting reports and XML files to a shared network folder or USB storage device. Turn On **Named Patient Folder** in the **End of Test Settings screen**. An automatically created patient folder name will consist of the patient's last name, first name, and date of birth. The patient ID will be added to the beginning of the folder name if the appropriate setting is enabled.

### Connect to a DICOM/EMR Server

This section contains instructions to connect the HFA3 instrument to a DICOM/EMR system including FORUM. Once connected, the instrument can display a list of patients who are scheduled for visual field exams from a worklist. When a patient is selected from this list, all demographic data are entered automatically into the local HFA3 database.

### Connection Settings

This section provides a description of the settings required to connect to a DICOM/EMR system. The majority of these settings do not affect or must be disabled when connecting to a non-DICOM EMR system (see "Connect to a Non-DICOM EMR," on [page 7-5](#)).

### Local Application Entity Settings

**Station name:** Typically a unique name for the exam lane or instrument. Enter a total of up to 16 characters and spaces.

**AE title:** Enter a unique AE title for the instrument. Each instrument must have its own unique AE title which needs to be registered with the DICOM system. Input a total of up to 16 characters (text is case-sensitive).

**Port:** Enter the Local Port number that the DICOM/EMR system connects to.

**Automatic MWL update:** Set to **Enabled** to automatically update Modality Work Lists.

**Frequency of MWL updates:** If Automatic MWL update is enabled, the Modality worklist refresh rate can be changed to the desired time period.

### Remote Application Entities

**MWL:** Enable this service to be able to import a worklist from the DICOM/EMR system.

**Storage:** Allows storage to the DICOM server.

**Query:** Enable this service to allow a patient search to FORUM.

**Retrieve:** Enable this service to automatically retrieve patient information.

Storage Commitment: Enable this service to perform a storage commitment request. This service is used to confirm that exam data have been permanently stored by the DICOM system.

### Advanced DICOM Settings

We recommend that you use the default values shown in the **Specific settings** dialog. Experienced network administrators may adjust these settings to optimize performance or allow for slow network connections.

### Configure DICOM

Select **Settings**  > **Specific settings**> **Report Output** >**DICOM** to access the Additional DICOM Settings screen.

Use these settings to adjust the configuration to your DICOM system. Consult your service provider for query settings that are specifically required by your DICOM compatible system.

**Include Today's Date:** Includes/excludes today's system date in the worklist query.

**Include AE Title:** Includes/excludes HFA3's AE title in the worklist query.

**Include Modality:** Includes/excludes OPV in the worklist query.

### DICOM Configuration Overview

The process for a complete DICOM solution includes the following steps:

1. **DICOM Server Setup:** Set up the DICOM storage to recognize the AE titles of the instruments that will be connecting to the server. Please consult your DICOM user manual or system administrator to configure your system.
2. **Network the HFA3:** Configure the HFA3 instrument to connect to the network with an Ethernet cable. See your IT administrator and "[Configure Networking Settings on the HFA3](#)," on [page 7-2](#) for more information.
3. **Configure the DICOM System:** Configure your system to communicate with the designated Storage and Modality worklist servers and perform a connection test.
4. **Use DICOM:** Query the Modality worklist server for scheduled exams, perform these exams, and export the results back to the DICOM server.

### Connect to FORUM

#### Configure Network Settings

1. Make sure you are logged in as an Administrator user.
2. Select **Settings**  > **Network** to display the Network screen.
3. Under **Connection Configuration**, set DICOM network to **Enabled** to display connection settings.
4. Enter values for Station name, AE title, and Port. Enable Automatic MWL update.
5. Configure DICOM Services automatically or manually.

#### Configure DICOM Services automatically:

1. Select the **AutoConnect...** button to display a list of detected FORUM servers.

2. Highlight the desired server and touch or click on **Select**. The DICOM system's AE title, Host-Name, and Port will automatically populate their fields.

#### Configure DICOM Services manually:

1. Check the DICOM services radio button  to configure MWL and Storage services only. The Retrieve, Query, and Storage Commitment settings will be configured from Storage. Leave the radio button unchecked if you wish to configure all services separately.
2. Highlight a service to configure from the Service list and select the **Manual connect...** button.
3. In the resulting dialog window, perform the following steps:
  - A. Enable or disable the service.
  - B. Enter the DICOM system's AE title. Input a total of up to 16 characters (text is case-sensitive).
  - C. Enter the DICOM system's Host-Name.
  - D. Enter the DICOM system's Port number.
  - E. Select **OK**.
4. Test connections to each service by using the **Test connection** button. A check mark will appear if the connection is successful.
5. Repeat steps 2., 3., and 4. for each service.

Enabled services display a check mark to the left.

#### Configure Export Settings

1. Select **Settings**  > **Specific settings**> **Report Output**.
2. In the **End of Test Settings** screen go to **DICOM Output** turn **On** FORUM Test Database to enable archiving to FORUM and subsequent deletion of exam data from the instrument. Export EPDF will be automatically disabled.

#### Connect to a DICOM Compatible EMR

Follow these recommended settings to connect to a DICOM compatible EMR system. Settings may need to be configured differently depending on your system. Consult your system manual or administrator.

#### Configure Network Settings

Follow the same procedure used to connect to FORUM. Configure DICOM services manually and make sure that MWL, Storage, and Storage Commitment are enabled. Query and Retrieve settings do not need to be configured.

#### Configure Export Settings



1. Select **Settings**  > **Specific settings**> **Report Output**.
2. In the **End of Test Settings** screen under **DICOM Output** turn **Off** FORUM Test Database.
3. Turn **On** Export EPDF to enable automatic export of EPDF at the end of testing.

#### Connect to a Non-DICOM EMR

Before configuring the HFA3 instrument:

- Make sure the EMR system is set up and running.
- Ensure that the HFA3 is connected to the network (see ["Configuration to Pre-existing Office Network,"](#) on page 7-2).
- Configure a shared network or FTP folder on the PC/Server that is accessed by the EMR system. Consult your IT administrator.

### Configuring Export to an EMR

1. Select **Settings**  > **Specific settings**> **Report Output**.
2. In the **End of Test Settings** screen, go to **DICOM Output**, and turn off **Forum Test Database**. If **Forum Test Database** is enabled, the **Reports** and **Tests** buttons will not be visible in the Patient screen.
3. Select **Settings**  > **Specific Settings** > **Non DICOM EMR Settings**.
4. Turn on EMR Mode.
5. Under **Export**, select the export settings.

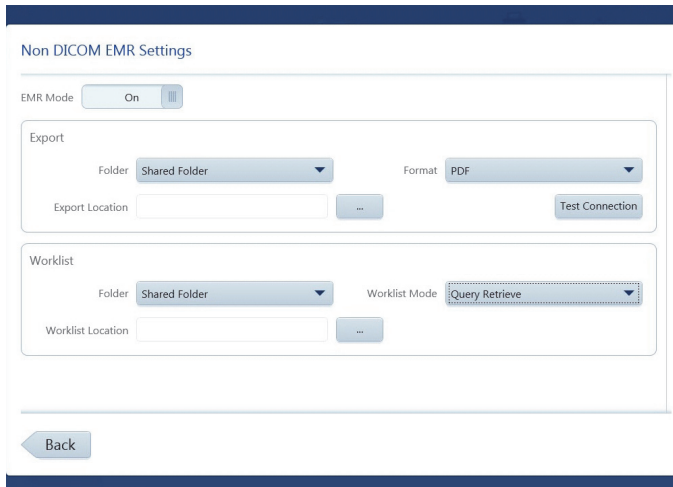

To export to a shared folder:

- A. From the Folder drop-down menu, select **Shared Folder**.
- B. In the **Network** screen, map a path to the shared folder previously set up on the PC/Server (see page 7-2). Select the mapped folder by selecting the triple dot  button.
- C. Initiate a test connection to the HFA3 on your EMR system. Select **Test Connection** on the HFA3. If you do not initiate a test on the EMR system, the connection will fail.
- D. Select the export format.

To export to an already existing FTP (File Transfer Protocol) folder:

- A. Select **FTP** from the Folder drop-down menu.
  - B. Enter the FTP server address in FTP Server. Begin the address with ftp://. Do not enter a backslash at the end, or the address will be invalid.
  - C. Enter the folder name in the Folder field.
  - D. Enter User name and Password for the FTP folder.
  - E. Initiate a test connection to the HFA3 on the EMR system. Then select **Test Connection** on the HFA3.
  - F. Select the export format.
6. Under **Worklist**, select the **Worklist Mode**. If you select **Query Retrieve** you can limit the selection by Accession Number, Last Name, First Name, and Patient ID.
  7. Map the location of the worklist, either to a shared folder or an FTP folder (see step 5).

### Configure Network Settings

1. Select **Settings**  > **Network** to display the Network screen.
2. Scroll down to **Connection Configuration** and enable DICOM network.
3. Under **Local application entity**, disable Automatic MWL update.
4. Under **Remote application entity**, manually disable Storage, Retrieve, Query, and Storage Commitment services (see steps 1, 2, and 3 in "Configure DICOM Services automatically," on page 7-4).
5. Highlight the MWL service and select **Manually connect...**

6. Enable MWL and enter these values in the next screen:
  - A. Enter **EmrSCP** under AE title.
  - B. Enter **localhost** under Host name.
  - C. Enter **2112** under Port.
  - D. Select **OK**.
7. Ensure that the EMR is integrated into the shared/FTP export and worklist folders before selecting **Test connection** on the instrument. A check mark will appear if the connection is successful.
8. Do not change the default values under **Specific settings**.

Enabled services display a check mark to the left.

### **Troubleshooting the Connection**

If the connection is unsuccessful, take the following actions:

- Check with your network administrator to verify that the instrument is connected to the network.
- Retry.
- Make sure the appropriate servers are running.
- The storage provider hard drive(s) may be full. Add more hard drives or make more space available.
- Refer to the **DICOM/EMR system manual** for a possible resolution of the problem.
- Call Customer Service.





## Connect to a Printer

This chapter contains instructions for:

- “Wireless Printers,” on page 7-8
- “Wired Printers,” on page 7-10
- “Shared Network Printers,” on page 7-10

## Wireless Printers

Connect the HFA3 to a wireless printer using a wireless adapter:

1. Ensure that both the HFA3 and printer are plugged in and turned on.
2. Open the side panel of the instrument to access the USB ports (see “The HFA3– Side Panel Opened,” on page 3-3).
3. Plug the USB wireless adapter into an HFA3 USB port.
4. Refer to the manufacturer’s printer instructions to configure the printer. For the HP Officejet Pro 251dw Wireless Color Printer use the following instructions:
  - A. On the printer screen select **Setup > Network > Wireless**. Set **Wireless** to **On**.
  - B. Use the Back button  to return to the previous screen.
  - C. Select **Wireless Direct** to access the Wireless Direct Settings. Select **On**.
  - D. Set **Security** to **On**.
  - E. Select **Security Passcode** and record the printer passcode visible on the screen. Select **OK**.
  - F. Select **Wireless Direct Name** and record the printer name. Select **OK**.
  - G. Return to the **Setup Menu** using the Back button. Select **Print Reports**.
  - H. Select **Network Configuration Page** to print the page and obtain the printer IPv4 IP address.
5. Access the Windows desktop on the HFA3:
  - A. In the Patient screen select **Change user** from the **Close** button menu . Log in as **Service** using **0000** as the password.
  - B. Select **Settings**  > **Service**.
  - C. In the Service screen select **Start service mode** and log off.
  - D. Select the **IT Administrator** login and enter **Admin@123** as the password. The Windows desktop appears.
6. Click on the network icon  located on the Task Bar in the Windows desktop.
7. Select the network connection for the wireless printer recorded in step 4.
8. Ensure that Connect automatically is checked and select **Connect**.



9. You are prompted for the network security key.



Enter the printer passcode recorded in step 4F as the Security key and select **OK**. A progress dialog box will appear.

10. Once the progress dialog box has closed and the connection has been established, restart the HFA3 by selecting the On/Off button. Cover the instrument or dim the room before restarting the HFA3.
11. Log in as **Administrator**.
12. Select **Settings**  > **General settings** and scroll down to **Printout**.
13. Select **Printer setup....** and select **Add printer**.
14. Select **Next** to move between the tabs in the following screen:

Printer setup

IP address	Paper size	Summary
<b>Name</b>	Printer connection	Connection

Please provide a name and short description to uniquely identify this printer.

Printer name

Description

Cancel Back Next Finish

**Name** - Enter a printer name (required) and optional description. Name and description are for your reference only.

**Printer connection** - Select **Directly**.

**Connection** - Printer port number should be automatically entered.

**IP Address** - Enter the printer IP address. Retrieve this address from network information on the printer (see manufacturer's instructions). Make sure that the printer IP address is within the range of the HFA3 IP address. Alternatively, select **Browse**, then either enter a server path or select **Browse** again to search for a printer. Once IP address is entered, select **Test** to test the printer connection. A green check mark will appear if the connection is good.

**Paper size** - Select paper size.

**Summary** - Displays a summary of all entered information.

15. Select **Finish** once you have entered all of the settings to add the printer to the printer list.
16. Highlight the printer in the printer list and select **Print test page** to test the printer.



Note: Any printer in the printer list can be set as the default.



**WARNING: If the instrument is externally connected to AC powered, non-medical peripheral devices (for example; printers, storage devices), the complete system must comply with the system requirements in standard IEC 60601-1. This standard requires the usage of an Isolation Transformer to power the non-medical peripheral device(s) if located within 1.5 m from the patient. If the peripheral device is located outside the patient environment (beyond 1.5 m) and is connected to the HFA, a separation device must be used or there shall be no electrical connection between the non-medical peripheral device and the HFA. The HFA3 Ethernet port already has the required separation integrated within the HFA3 instrument, and therefore can be directly connected to peripherals located beyond 1.5 meters.**

**Wired Printers**

To connect directly to a PostScript printer when an HFA3 is in local database mode:

1. Ensure that the HFA3 has not been connected to a local network.
2. Connect the appropriate cable to the Ethernet port on the instrument (see [“The HFA3– Side Panel Opened,”](#) on page 3-3) and the printer (refer to manufacturer’s instructions).
3. If not already on, turn on the printer and the HFA3 (ensure that both devices are plugged in), and log into the instrument as **Administrator**.
4. Select **Settings**  **> Network** and note the HFA3 IP address. The IP address should be in the range of 169.254.1.0 – 169.254.1.255 if the instrument has not previously been connected to a network.
5. To set up the printer on the instrument, follow steps 12.–16. in [“Wireless Printers,”](#) on page 7-8.

**Shared Network Printers**

To connect to a shared network printer:

1. Verify the IP address of both the HFA3 and the printer to ensure that they are on the same local network.
2. On the instrument, log in as **Administrator**.
3. To set up the printer on the instrument, follow steps 12.–16. in [“Wireless Printers,”](#) on page 7-8. Ensure in step 14. to select **Print server** as the **Printer connection**.



## (8) Maintenance

This chapter discusses instrument cleaning and customer-replaceable parts.

ZEISS recommends routine yearly service and maintenance of the HFA3 by a qualified ZEISS Field Service Engineer.



Only an authorized ZEISS service representative should calibrate the HFA3. Contact a ZEISS service technician if you think your instrument requires calibration.

### Cleaning the Instrument

Clean as often as is necessary. Use the methods and cleaners shown in the table below.

Surface	Cleaner	Method
Exterior Panels	Mild detergent or appliance cleaner or glass cleaner containing no ammonia.	Dampen a soft cloth with cleaner and gently wipe the surfaces. Never spray the cleaner directly on the exterior surfaces.
Bowl (Please review the two cautionary Notes that follow this table)	Dust cloth  Distilled water  70% Isopropyl alcohol in H <sub>2</sub> O (Rubbing alcohol)	Remove accumulated dust from the bowl periodically. Wipe the bowl gently with a clean, dry, soft cotton cloth. Use downward strokes that move the dust toward the front edge of the bottom of the bowl, where there is a small opening around the base of the lens holder.  If dusting the bowl is inadequate, slightly moisten the cloth with distilled water. Whether using a dry or a dampened cloth, always avoid excessive rubbing in one area, as this can create shiny spots or wear through the specially painted surface of the bowl.  For small spots on the bowl surface caused by sneezing or coughing during a test, slightly dampen a cotton-tipped applicator with isopropyl alcohol and gently remove the spot. It is best to wet the spot with the tip of the dampened swab first and let it soak briefly. Then, use the swab very gently to remove the deposit.
Touch Screen	Mild glass cleaner containing no ammonia.	Turn off the HFA before cleaning the touch screen. Wipe gently with a moistened cloth. Do not spray cleaner directly on the touch screen.
Forehead & Chin Rests	Mild detergent, alcohol wipes	After each patient, wipe gently using a dampened soft cloth.
Patient Response Button	Mild detergent, alcohol wipes	After each patient, wipe gently using a dampened soft cloth.

Table 8.1

-  Note: Be careful to avoid scratching, discoloring, or staining the bowl surface. Prior to cleaning the bowl surface, remove all jewelry as it can permanently scratch or damage the painted surface. Be especially careful of long fingernails and fingernail polish contacting the bowl surface, as these can mark or damage the painted surface permanently.
-  Note: During any bowl cleaning process, be careful to avoid getting either the distilled water or isopropyl alcohol cleaning liquid inside of the fixation target openings or on mirrored surfaces.

**Air Intake Filter**

To ensure proper cooling of the instrument, the air filter must be cleaned or replaced every three months (Part Number 2660021149222).

1. Locate the air filter cover on the side of the instrument.
  - Push down on the filter cover latch and open the cover.
  - Remove the air filter.



Note: The air filter is marked with a notch on the bottom. Observe the proper orientation of the air filter before removal and replace the air filter in the same orientation.

2. Clean or replace the air filter.
  - For cleaning, shake the air filter a few times to dislodge trapped dust.
  - The filter may be rinsed with water, but make sure the filter is completely dry before installing.
  - To replace the air filter, call the Carl Zeiss Meditec Parts Department and order a "Fan Filter" (PN 2660021149222).
3. Return the new air filter or the clean and dry air filter to its proper location.
4. Close and latch the air filter cover.

**Replacing the Stimulus Projection Lamp**

This lamp is responsible for projecting the standard white stimulus. With the aid of color filters, it is also used to create red and blue stimuli for color testing. If needed, order a new lamp by calling the Carl Zeiss Meditec Parts Department and asking for PN 2660021148110 (Projection Lamp).

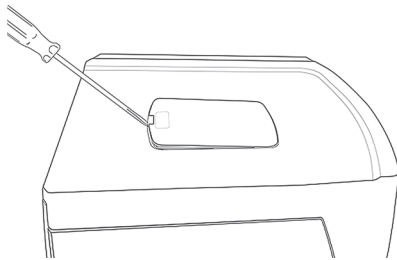

1. Turn off the HFA3 and lower the table. Open and remove the top access panel using an implement to release the catch mechanism.

2. Standing in front of the bowl opening, the projection lamp is located inside the open case top, at the 12 o'clock position. Allow the lamp to cool completely (approximately five minutes) before handling it. Do NOT touch the two disk-shaped filters.

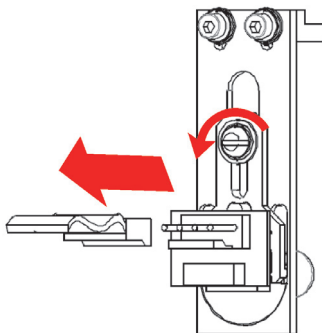

3. Remove the connector cable by pulling its connector straight upward. Then use a screwdriver to loosen the screw.

4. Now, slide the wishbone-shaped plate that holds the lamp assembly in place away from you.

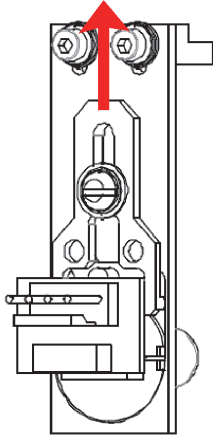

5. Remove the old expended lamp assembly. Insert the replacement lamp into the housing. Note the notch in the base of the lamp housing lines up with the pin to the right of the assembly. Do NOT touch the glass part of the lamp with your fingers, as this will shorten the life expectancy of the lamp. If your finger touches the glass portion of the lamp, wipe the lamp clean with a soft cloth.

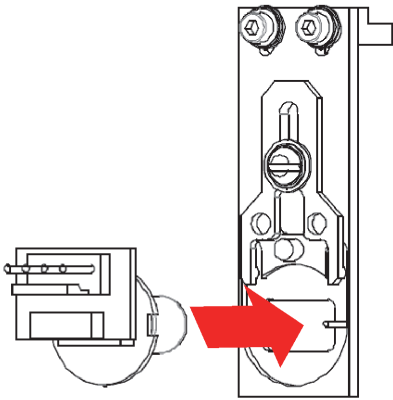

6. Slide plate back into position, tighten screw and replace connector cable.

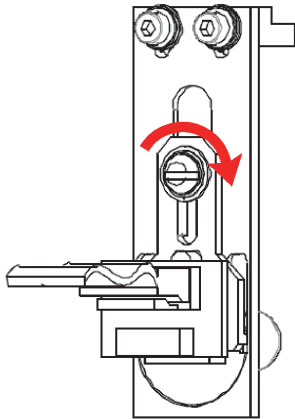

7. To replace the top access panel, insert the panel into the opening.

### Background Illumination Lamps

The lamps responsible for illuminating the bowl surface are a fluorescent type (not incandescent) and have a long life expectancy. If you get a bowl illumination error, darken the room and restart the instrument to see if this corrects the problem. If the bowl illumination error continues, do NOT attempt to replace the lamp. These highly specialized lamps are to be replaced only by a ZEISS Field Service Engineer. Contact ZEISS Customer Service to arrange for a service call.

### Patient Response Button

Should the response button malfunction, disconnect it and replace it with a new response button. The part number (PN) for the Patient Response Button is 2660100029575 and can be ordered from the Carl Zeiss Meditec Parts Department.

### Liquid Trial Lens Care

#### Check Liquid Trial Lens Using a Lens Analyzer

The Liquid Trial Lens calibration can be verified on a lensometer used to check spectacle lenses.



Note: The Liquid Trial Lens does not require periodic maintenance.

Use gloves during the procedure to avoid soiling the lens surface. Be careful not to touch the inside of the bowl with your hand or the lens holder.

1. Add a test patient to the HFA3 while in the **Patient screen** (see “Add New Patient,” on page 4-2).
2. Set the Liquid Trial Lens to the desired spherical correction. See “Enter Distance Prescription and Trial Lens Data (Optional),” on page 4-3. The full range of the Liquid Trial Lens is  $-8.00$  to  $+8.00$  D.
3. Wait 5 seconds for the Liquid Trial Lens to position itself.
4. Remove the Liquid Trial Lens from the HFA3 (see page 4-3).
5. Holding the Liquid Trial Lens by hand, place the lens so that the surface nearest to the patient’s eye during a perimetry test is in contact with the lensometer read head. Make sure that the lens surface is flat and in contact with the read head.

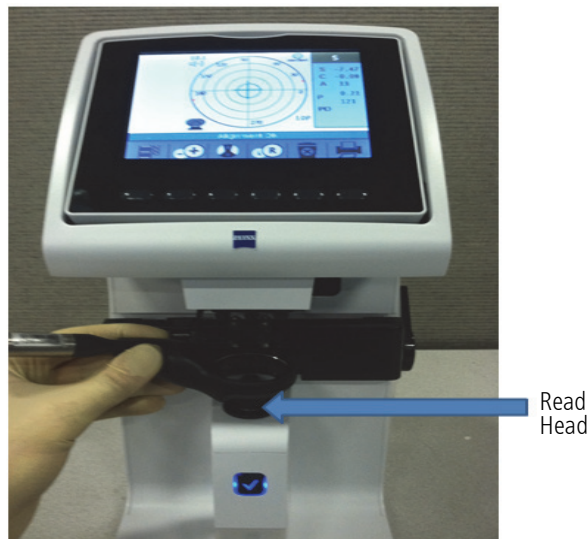

6. Center the lens following the lensometer protocol. Most lensometers will show a cross representing the lens center and a target. The lens center should be aligned to the center of the target.
7. If a cylinder is present, calculate the spherical equivalent power as  $SEP = Sph + 0.5Cyl$ .
8. The measured spherical equivalent power of the Liquid Trial Lens should be within  $\pm 0.25$  Diopters of the set value. The measured cylinder should be less than  $\pm 0.25$  Diopters from  $-5.00$  to  $+5.00$  Diopters and less than  $\pm 0.375$  Diopters outside of that range.

**Cleaning the Liquid Trial Lens**

Clean the lens with a soft cloth or tissue and one of the following cleaners: 70% isopropyl alcohol in water (rubbing alcohol), or mild glass cleaner containing no ammonia.

**Accessories and Supplies List**

Part Number (PN)	Description
2660021148110	Projection Lamp
2660021149222	Air Filter, Rear Fan
2660100014176	Anti-static Wipes (10)
2660021146660	HFA3 Dust Cover
2660100008025	Eye Patch
2660100029575	Patient Response Button
2660021150432	Liquid Trial Lens
2660021154571	Manual Trial Lens

**Table 8.2**

Note: Item part numbers and descriptions are subject to change.

To order parts, call ZEISS Customer Care at 1-800-341-6968. Outside the U.S., contact your local ZEISS distributor.



## (9) Data Transfer

This chapter describes how to move tests from an older Humphrey Field Analyzer model (either the HFA II or an HFA II-*i*) to an HFA3 in local database mode. Transfer data by using the instrument's network connection, a USB device, or by connecting a serial cable to the Data Transfer ports of two HFA instruments. Serial connections can be: HW COM port, COM-USB adapter or COM-Network adapter. The HFA3 is able to combine HFA II, HFA II-*i* and HFA3 data to create reports.

To transfer data from an HFA II or HFA II-*i* to the FORUM server see the *Humphrey® HFA™ Connect Software Installation Instructions*. Data on the server can then be accessed by an HFA3 in FORUM connected mode.

### Set Up a Serial Transfer from an HFA II or HFA II-*i*

Setup for Data Transfer

1. Connect the Serial cable to the originating HFA serial transfer port.
2. Connect the other end of the serial cable to the receiving HFA3 USB port.
3. The "Communication" field below will display a number when the connection is live.

COM

4. Confirm that the originating HFA instrument's settings are set to these values:

Baud Rate = 9600	<b>HFA II and II-i Settings Instructions:</b> Go to System Setup screen and select one of the following setup options depending on the HFA model: 1. HFA II: Save/Transmit Option > RS-232 Option
Parity = Even	
Data Bits = 7	
Stop Bits = 1	

To set up a data transfer from an HFA II or HFA II-*i*:

1. Go to **Settings**  > **Specific Settings** > **HFA Data Transfer**.
2. Follow the detailed instructions on the screen to set up a serial transfer between an HFA II or HFA II-*i* and an HFA3.
3. Select **Next** once the two instruments are connected.

Confirmation: Patient ID # Addition and Name Splitting

1. Confirm Patient ID # Addition  
 The HFA 3 database requires an ID number for each patient record. If a record from an older HFA has an empty field for ID number, the HFA 3 Data Transfer program will automatically add an ID number. If an ID number already exists, then no change will be made. This selection must be confirmed prior to proceeding. See the user manual for the method used to assign an ID number.  
 **Off** Patient ID # Addition during data transfer
2. Confirm Name Splitting  
 The Patient Name fields in earlier versions of HFA II and HFA II-*i* may have used a single name format, whereas the HFA 3 uses a multiple-field name format. This application can automatically split the HFA II or HFA II-*i* name format into the HFA 3 name format. See the user manual for the method used to split the name fields.  
 **Off** Name Splitting during data transfer

4. In the next screen, choose **On** to add a patient ID number during data transfer. This feature is required for data import. **Note:** A unique 29-character Patient ID will be automatically created for the patient from the patient's name and date of birth.

5. Name splitting is a mandatory feature automatically set to **On**. **Note:** HFA II and HFA II-*i* (software versions before 5.0) used one name field for patient records. To generate a report using patient data on the HFA3, you must change the patient record to include a separate first and last name. See "Name Splitting," on page 9-2.

6. Select **Next** to proceed to the next screen.

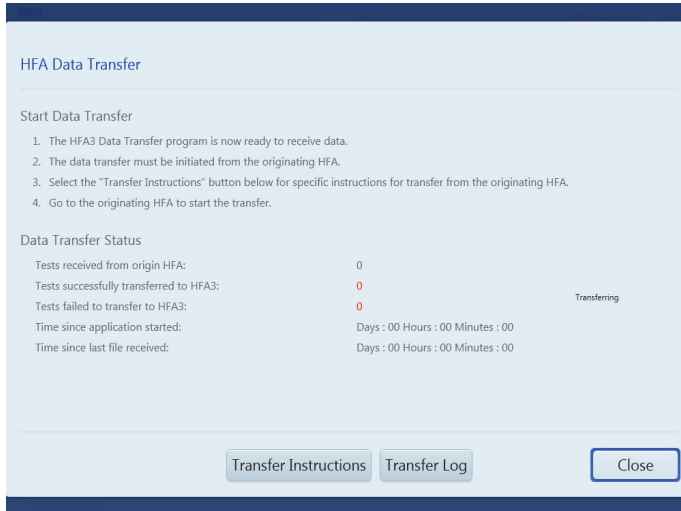

7. Follow the detailed instructions on the screen.
8. Select **Transfer Instructions** for specific instructions on initiating manual data transfer from an HFA II or HFA II-*i*.
9. Select **Transfer Log** to view a summary of the data transfer.
10. Select **Close** to close the screen.

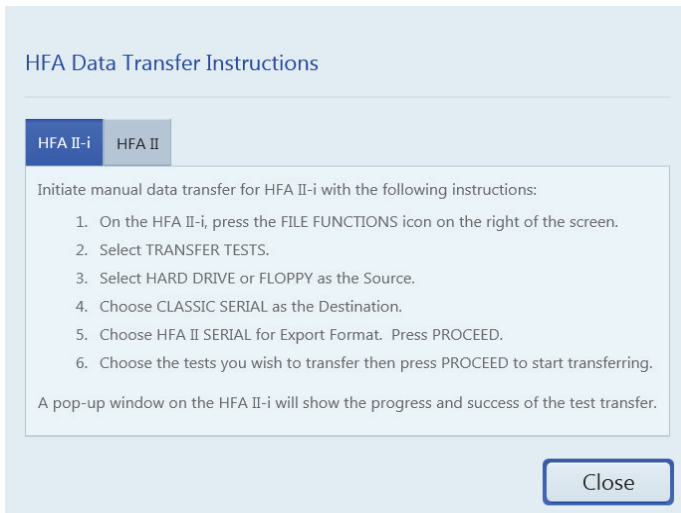

11. Follow the detailed instructions on the HFA DATA TRANSFER INSTRUCTIONS screen.
12. Select **Close** to return to the previous screen to monitor the transfer process on the HFA3.

**Note:** Reports generated on the HFA3 after importing kinetic data from an HFA II or HFA II-*i* may be different from reports generated on the HFA II or HFA II-*i* using the same data. These differences are due to retested points not being displayed on the HFA3.

### Name Splitting

When patient records, created in HFA II or HFA II-*i* (software versions before 5.0), are transferred to the HFA3, the entire patient name will appear in the **Last Name field** when the Name Splitting feature is off. To avoid this, the **Name Splitting** feature is set to **On** per default during data transfer.

The preprogrammed rules for name splitting are:

1. Read from the end of the name to the first delimiter (comma, space, or caret character) and assign those characters to the **Last Name** field on the HFA3.
2. Continue reading from right to left and assign all remaining characters to the **First Name** field.
3. If no delimiter is found, all characters will be assigned to the **Last Name** field.
4. No information is added or removed in the process of Name Splitting.
5. In HFA software version 5.0 or higher, names will be split according to DICOM conventions.



## **(10) Data Synchronization**

HFA3 Data Synchronization is a function that allows network connected HFA3 instruments to share all the tests in their database so that all HFA3 instruments have a synchronized complete set of HFA tests. In addition, HFA II-i (version 5.0 or 5.1) instruments can be connected to the HFA3 instruments to contribute new tests as they are taken on the HFA II-i. The result of this configuration is that patients can be tested on any of the connected HFA3 instruments with access to the most recent patient record and the reports are generated using the full test history of the patient.

Important HFA3 Data Synchronization elements are:

- Function is built into the HFA3, no external database or software is required.
- HFA3 instruments synchronize the test database.
- HFA II-i only contributes new tests to the HFA3 database, which is then synchronized with other HFA3 instruments.
- All HFA3's retain existing configured EMR, Export, and Print output connections.
- HFA3 automatically generates reports and sends them to the designated output locations, even when the test came from the HFA II-i.
- If a report is needed after a test has already been completed, this report must be generated from an HFA3, not the HFA II-i.
- HFA II-i should NOT be used to Export or Print reports.
- Patient records must be edited and merged on an HFA3. These edits will be synchronized to all connected HFA3's.
- If changes to a patient record are made on an HFA II-i, those changes will NOT be communicated to the HFA3.
- EMR connectivity is not affected by Data Synchronization. Modality Worklists are communicated to all connected HFA3 and HFA II-i instruments. Reports will be returned to the EMR as designed.

## Installation & Configuration of Data Synchronization Function

### Summary of Data Synchronization Set-up Steps

Step	Time Required	Status of Instrument
Upgrade all HFA II-i to version 5.0 or 5.1 and connect to the same network.	0.5 - 1 hour	HFA II-i cannot be used during software upgrade.
Upgrade all the HFA3 to version 1.5 and connect to the same network.	0.5 - 1 hour	HFA3 cannot be used during software upgrade.
Configure HFA II-i to <b>Data Synchronization</b> mode with HFA3 (if applicable).	15 - 30 minutes	HFA3 and HFA II-i cannot be used.
HFA II-i Data Transfer to HFA3 (if applicable).	1 - 10 hours	HFA II-i cannot be used.
Configure all HFA3 to <b>Data Synchronization</b> mode.	5 - 10 minutes	HFA3 cannot be used.
HFA3 synchronizes all tests between HFA3 instruments.	2 - 48 hours	HFA3 instruments can be used but only have access to patients and tests on that instrument's database.
Synchronization complete. Restart all HFA3 instruments.	10 minutes	After restart, all HFA3 are in full synchronized <b>Data Synchronization</b> mode.

Table 10-1 Summary of Data Synchronization Set Up Steps

### Detailed Data Synchronization Set-up Steps

- [“Scenario 1: Turn ON Data Synchronization Functionality for Two or More HFA3,” on page 10-2](#) describes Data Synchronization for **two or more** HFA3 instruments and explains how to turn on the Data Synchronization function in each HFA3 instrument.
- [“Scenario 2: HFA II-i \(one or more\) and HFA3 \(one or more\) Data Synchronization,” on page 10-6](#) describes Data Synchronization for **one or more** HFAII-i and HFA3 instruments and explains how to turn on the Data Synchronization function and transfer the data. Scenario 1: Two or more HFA3 - Data Synchronization

Step	Description
<b>Scenario 1: Turn ON Data Synchronization Functionality for Two or More HFA3</b>	
1. Meet precondition requirements.	Upgrade all the HFA3 instruments to version 1.5 and ensure each is connected to the same network with DHCP.

Table 10-2 Scenario 1: Turn ON Data Synchronization Functionality in HFA3



Step	Description
<p>2. Log in to Service</p>	<p>From main <b>Patient</b> screen, select the <b>Change user</b> from the Close button menu.                      Use drop down menu to select login option <b>Service</b>.                      Password is <b>0000</b> (four zero's)</p> <p style="text-align: center;">Enter user credentials to start.</p>  <p><b>Note:</b> The Synchronization function is only available through the <b>Service</b> login.</p>
<p>3. Select Settings</p>	<p>Select <b>Settings &gt; Service</b>                      Go to <b>Synchronization &gt; Start/Stop Synchronization &gt; select Enabled</b></p>  <p>Click on <b>Back</b>.                      The circle arrow icon indicates that the HFA3 needs to be restarted after this selection.</p>  <p>Confirm the restart by selecting OK. After shutdown the HFA3 needs to be restarted.</p>  <p>Login as <b>Administrator</b>.</p> <p style="text-align: center;">Enter user credentials to start.</p> 

Table 10-2 Scenario 1: Turn ON Data Synchronization Functionality in HFA3

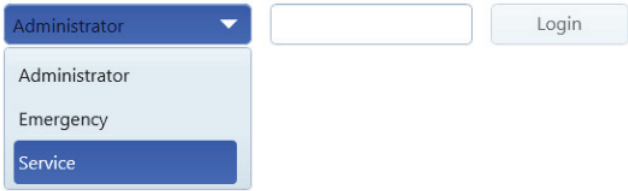
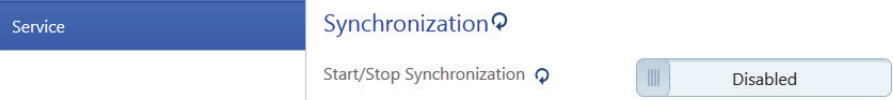
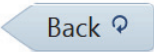
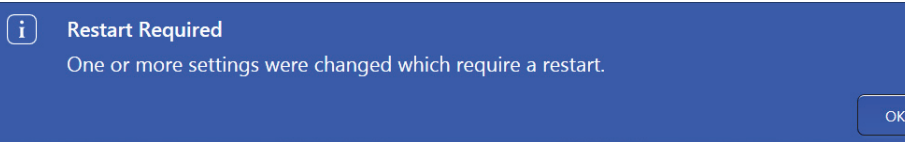

Step	Description																									
<p>4. Confirm all HFA3 instruments are connected.</p>	<p>Go to <b>Settings &gt; Networking &gt; Synchronization Configuration</b>. The <b>Available Instruments</b> now shows the HFA3 instruments detected.</p>  <p><b>Settings</b></p> <p>Network Drive Configuration</p> <p>Configured Network Drives</p> <table border="1"> <thead> <tr> <th>Drive Letter</th> <th>Network Path</th> </tr> </thead> <tbody> <tr> <td>✓ S:</td> <td>\\sforum_win7x6\SC Backups</td> </tr> </tbody> </table> <p>Reconnect Unmap Map...</p> <p>Synchronization Configuration</p> <p>Synchronization Group <input type="text" value="HFA3DEVICE"/></p> <p>Available instruments</p> <table border="1"> <thead> <tr> <th></th> <th>Hostname</th> <th>IP Address</th> <th>Product Name</th> <th>Software Vers...</th> <th>Build Version</th> <th>Repl</th> </tr> </thead> <tbody> <tr> <td>✓</td> <td>860-00050</td> <td>10.174.24.20</td> <td>Humphrey Fi...</td> <td>1.5.0.715</td> <td>1.5.0.715</td> <td>HFA</td> </tr> <tr> <td>✓</td> <td>830-10056</td> <td>10.174.24.21</td> <td>Humphrey Fi...</td> <td>1.5.0.715</td> <td>1.5.0.715</td> <td>HFA</td> </tr> </tbody> </table> <p>Add Remove Refresh</p> <p>DICOM Configuration</p> <p>Back</p> <p>Green check = connected.            Red circle with white line = not connected.            Add = manually add an instrument not found by entering the host name or IP address.            Remove = remove a manually added instrument. This will not remove an instrument that was automatically found.            Refresh = try to connect.</p> <p>Confirm that all HFA3 instruments that you intend to synchronize are named exactly the same in the <b>Synchronization Group</b>. The default name for all HFA3 instruments is <b>HFA3DEVICE</b>.  <b>Note:</b> If the Synchronization Group name is changed, you will need to restart the instrument to take affect.</p> <p>Perform the same set up process on all HFA3 instruments that are to be synchronized. <b>Available Instruments</b> shows the HFA3 instruments detected in the network.  <b>Note:</b> Do NOT change any other settings on the Network page. EMR connections are not to be affected by Synchronization and you should NOT need to re-configure anything.</p>	Drive Letter	Network Path	✓ S:	\\sforum_win7x6\SC Backups		Hostname	IP Address	Product Name	Software Vers...	Build Version	Repl	✓	860-00050	10.174.24.20	Humphrey Fi...	1.5.0.715	1.5.0.715	HFA	✓	830-10056	10.174.24.21	Humphrey Fi...	1.5.0.715	1.5.0.715	HFA
Drive Letter	Network Path																									
✓ S:	\\sforum_win7x6\SC Backups																									
	Hostname	IP Address	Product Name	Software Vers...	Build Version	Repl																				
✓	860-00050	10.174.24.20	Humphrey Fi...	1.5.0.715	1.5.0.715	HFA																				
✓	830-10056	10.174.24.21	Humphrey Fi...	1.5.0.715	1.5.0.715	HFA																				
<p>5. Synchronize all databases.</p>	<p>The main screen header shows the Database icon with rotating arrows, indicating: <b>Data Synchronization in progress</b>.</p>  <p><b>Note:</b> Synchronization of all databases may take up to 48 hours (depending on number of tests in HFA database). During this time, new tests can be run on each HFA3 and reports are generated using the test data available on that one instrument’s database. However, it will not have access to all tests until full synchronization is completed.</p>																									

Table 10-2 Scenario 1: Turn ON Data Synchronization Functionality in HFA3

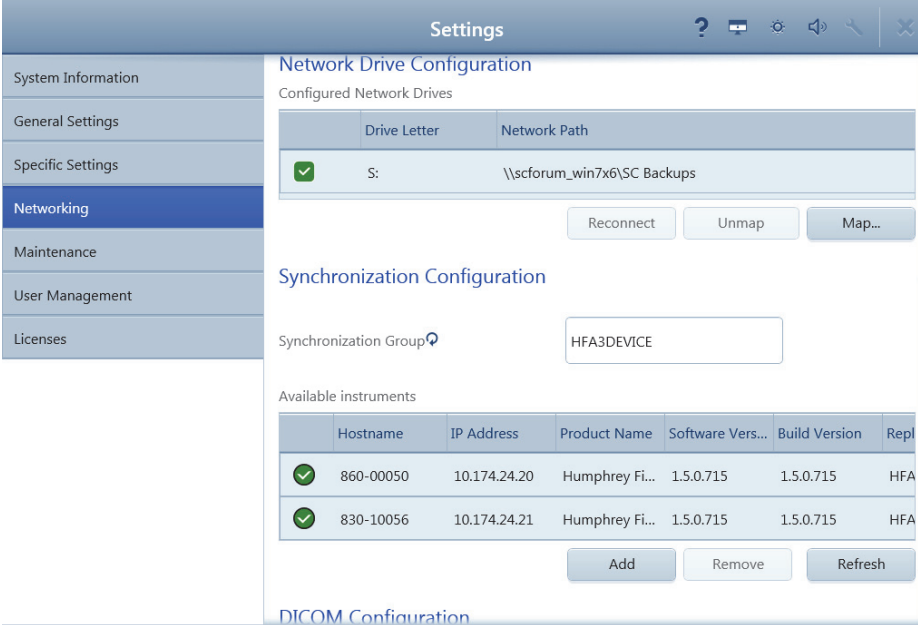

Step	Description
6. Complete synchronization.	<p>The main screen header shows the database icon with check mark, indicating: <b>Synchronization Complete.</b></p>  <p>The HFA3 has completed synchronization and is ready for final restart to complete the process to screen for duplicate patient records.</p> <p>Selecting <b>OK</b> initiates the process to screen for duplicate patient records. This step takes 5-10 minutes and the instrument is not available for use during this time.</p> <p>Selecting <b>Cancel</b> keeps the process from starting. This message is repeated at next start up until this step is completed by clicking <b>OK</b>.</p>
7. Run duplicate check.	 <p>You receive the message: Synchronization Complete - Your HFA3s are now synchronized. Please backup your database as soon as possible. HFA3 can now identify duplicate patients in your database. Do you want to perform this check now? Click <b>Yes</b> to perform, or click <b>No</b> to perform the check later. For more details see Duplicate Patients under "<a href="#">Specific Settings</a>," on page 3-13.</p> <p>Select <b>Yes</b> to perform the check.</p> <p>Once this screening is completed, all HFA3 instruments are now ready for use in full Data Synchronization mode. All test data is synchronized and available to all instruments. When new tests are run, they are automatically synchronized between HFA3 instruments. The duplicate record screen is automatically performed. You do not need to initiate any action.</p>
8. Verify completion.	<p>You can verify the completion of the Data Synchronization go to <b>Settings &gt; System Information &gt; Database</b> and view the <b>Total Patient Records</b> and <b>Total Tests</b>.</p>
9. Check flagged duplicates.	 <p><b>Duplicate record indicator</b></p> <p>After the Data Synchronization and Duplicate Patient check are complete, you may see patient records identified as possible duplicates with the icon next to a patient name in the search results list. This flag helps you in your data management because the patient records from all instruments are now synchronized and the HFA3 has automatically detected possible duplicates. This can occur when records were independently created on different instruments and may have differences in the way the name, ID#, or Date of Birth were entered. The HFA3 identifies and flags these records that are possible duplicates. When the operator sees a record that is flagged, they should evaluate the possible duplicates and either merge records, or leave them as separate records, as appropriate.</p> <p>See "<a href="#">Potential Duplicate Patients</a>," on page 3-14 for more information.</p>

Table 10-2 Scenario 1: Turn ON Data Synchronization Functionality in HFA3

## Scenario 2: HFA II-i (one or more) and HFA3 (one or more) Data Synchronization

Step	Description
<b>Scenario 2: Turn ON Data Synchronization for One or More Data Synchronization HFA II-i and HFA3</b>	
1. Meet precondition requirements.	<ul style="list-style-type: none"> <li>• Ensure that all the HFA II-i instruments are version 5.0 or 5.1 and connected to the same network.</li> <li>• Ensure that all the HFA3 instruments are version 1.5 and connected to the same network.</li> </ul> <p><b>Note:</b> One HFA3 will be identified for connection for each HFA II-i. More than one HFA II-i can be connected to one HFA3. If there are two or more HFA3 instruments, choose one to connect the HFA II-i. The HFA3 instruments are synchronized and include the HFA II-i test in the synchronization.</p>
2. Allocate static IP address.	Allocate a Static IP address for each HFA3 instrument that will be connected to an HFA II-i.
3. Disable DHCP and enter static IP address.	<p>For the HFA3 that will be connected to the HFA II-i, change the HFA3 to Static IP:</p> <ul style="list-style-type: none"> <li>• On HFA3, go to <b>Settings &gt; Network</b></li> <li>• Go to: <b>DHCP &gt;</b> use slider to select: <b>Disabled</b></li> <li>• Enter the Static IP address assigned to the HFA3.</li> </ul> <p><b>Note:</b> The HFA3 instruments NOT connected to an HFA II-i can remain as DHCP.</p>

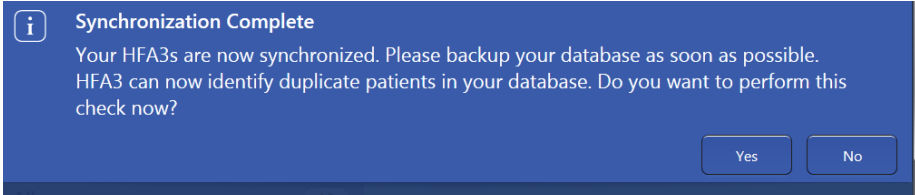
Table 10-3 Turn ON Data Synchronization Functionality in HFA II-i and HFA3

## Configuration for Data Synchronization

There are two choices depending on the model:

- [HFA II-i \(USB drive\) - Configuration for Data Synchronization](#), OR;
- [HFA II-i \(Floppy drive\) Configuration for Data Synchronization - Manual Configuration](#)

Step	Description
<b>HFA II-i (USB drive) - Configuration for Data Synchronization</b>	
1. On the HFA II-i	Go to: <b>System Setup &gt; Additional Setup &gt; Backup Configuration</b> A dialog appears prompting you to select a USB storage device. Do the following steps: A. Insert a USB storage device into a USB port on the HFA. B. Select the desired <b>USB storage device</b> by pressing the button with its <b>device name</b> . C. When the message: <b>Configuration Backup is complete</b> appears, press <b>OK</b> to return to the <b>Additional Setup</b> screen. D. Remove USB drive when backup is completed.
2. On the HFA3	Go to: <b>Settings &gt; Specific Settings &gt; HFA II-i Configuration</b> . Take the USB drive to the HFA3. Do the following steps: A. Insert USB drive into USB port. B. Enter <b>HFA II-i Serial Number</b> . C. Select <b>Update configuration</b> . D. Remove USB drive when update is completed.
3. On the HFA II-i	Take the USB drive back to the HFA II-i and do the following steps: A. Select <b>System Setup &gt; Additional Setup &gt; Restore Configuration</b> B. Insert USB drive into USB port. C. Select the <b>appropriate media</b> by pressing the button with its <b>device name</b> . D. When the message: <b>Configuration update is complete</b> appears, press <b>OK</b> . E. After a 15 second pause, your HFA II-i will restart automatically.
<b>HFA II-i (Floppy drive) Configuration for Data Synchronization - Manual Configuration</b>	
1. On the HFA3	Go to: <b>Settings &gt; Specific Settings &gt; HFA II-i Configuration</b> A. Enter the <b>HFA II-i serial number</b> . B. Select button: <b>Manual Settings</b> . C. Print out the instructions from the HFA3. D. Go to the HFA II-i and follow the instructions.

**Test Connection and Patients**

Next step is to test the connection from HFA II-i to the HFA3 and test the patients with the HFAII-i in Data Synchronization Mode.

Step	Description
<b>Test Connection HFA II-i to HFA3</b>	
1. On the HFA II-i	Test the exam transfer. A. Set the HFA II-i into <b>Simulated mode</b> . B. Create a <b>demo patient</b> and run a test.
2. On the HFA3	Check on the HFA3 for the patient and the test after it is completed.
3. On the HFA II-i	Test connection is completed. Proceed with next step: <b>HFA II-i Test Transfer to HFA3</b>
<b>HFA II-i Data Transfer to HFA3</b>	
1. On the HFA3	<b>Note:</b> The HFA3 will store all the HFA II-i tests, combine them with HFA3 tests, and use them to generate reports going forward. The first step is to transfer all the existing HFA II-i tests to the HFA3. After this, each new test run on the HFA II-i will be automatically stored on the HFA3.
2. On the HFA II-i	Go to: <b>File Functions &gt; Transfer Tests</b> Select: A. Source = Hard Drive B. Destination = DICOM Archive C. Export Format = Exam data D. Current Range = All files E. Proceed F. Enter G. Select All H. Proceed  <b>Note:</b> This will initiate a copy of all tests in the HFA II-i database to the HFA3. The tests will still be on the HFA II-i database. The transfer takes about 1 hour per 10,000 tests. For example, a test database with 50,000 tests will take about 5 hours to transfer. This should be started when convenient for having the HFA II-i unavailable for this time. (Recommended is after completion of a test day.)
<b>Testing Patients with the HFA II-i in Data Synchronization Mode</b>	
1. On the HFA II-i	<b>Note:</b> To use the HFA II-i for testing patients, you can search for a patient in the database (DICOM Archive) or select from a worklist (Worklist). <b>Note:</b> New patients that are added in the HFA II-i will be transferred to the HFA3 for storage after the test is run.
2. On the HFA II-i	Select a test. A. Select: <b>Recall Patient Data</b> B. Source: • DICOM Archive (if NOT using an EMR worklist) • Worklist (if using an EMR worklist) C. Enter <b>Patient name</b> or <b>ID</b> D. Proceed



## (11) Data Backup

This chapter describes how to protect the patient database.

### Data Backup on Shutdown and Data Restore

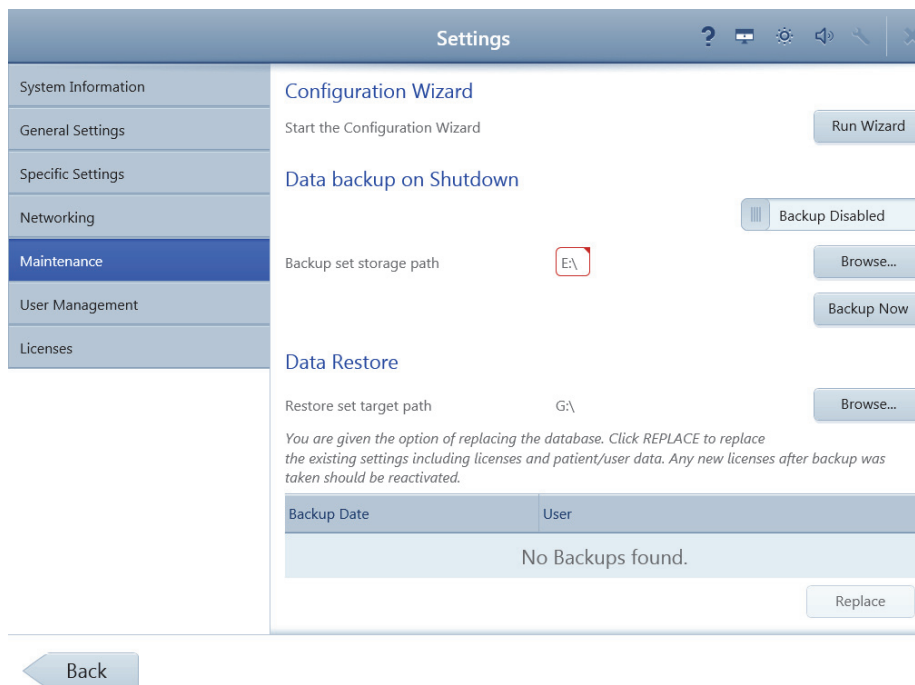

Button	Function
Data backup on Shutdown	Use the slider to <b>Enable</b> or <b>Disable</b> the data backup. It is strongly encouraged to set up the backup by enabling and setting a path to a back up location.
Backup set storage path	Use <b>Browse...</b> to select a backup location. Ideally this is a network folder. Alternatively, it can be a USB drive in one of the HFA3 USB ports. Backup Now: Starts data backup immediately to the specified location.

Button	Function
Data Restore	Used to restore the database from a saved backup. The restore function replaces any existing data with the backup data.
Restore set target path	Use <b>Browse...</b> to select the drive where backup files are located. Backup list: The most current backup is listed by date and time. To restore the database, refer to Restoring the Database. <b>To restore the database:</b> <ol style="list-style-type: none"><li>1. Browse... to select the drive where backup files are located</li><li>2. Select the backup from the list under Restoring data.</li><li>3. Select Replace.</li><li>4. Confirm your selection.</li><li>5. When the restore operation is complete, a confirmation displays.</li><li>6. Select Restart to restart the instrument.</li></ol>

## (12) Specifications

### HFA3 Instrument

#### Stimulus

- Maximum Intensity: 10,000 ASB
- Duration: 200 msec, 500 msec for Esterman tests, continuous for kinetic tests
- Wave Length: Broadband visible light

#### Visual Field Testing Distance

- 30 cm

#### Bowl Illumination

- 31.5 ASB

#### Maximum Temporal Range

- 90 degrees (90°)

#### Dynamic Range

- 50 dB

#### Computer

- Operating System: Windows 7 or 10 – 64 bit
- Intel® Core i7-610E
- Internal storage: 500 GB
- 6 external USB ports, Type A, USB 2.0 specification
- Ethernet Port (4KV isolated GbE)
- DisplayPort video output
- 12V  power outlet
- USB Keyboard & Mouse
- LCD Display with integrated touch screen

#### Physical

- Dimensions: 46 L x 52 W x 58 H (cm)
- Weight: 28.7 kg (63 lbs.)

#### Electrical Requirements

##### Electrical Rating

- 100–120V~, 50/60Hz, 4.0A
- 230V~, 50/60Hz, 1.8A

#### Environmental Conditions

##### Transport (Packaged)

- Temperature: –40 to +70°C
- Humidity: 10% to 95%
- Atmospheric Pressure: 500 to 1060 hPa
- Vibration, sinusoidal: 10 Hz to 500 Hz: 0,5 g
- Shock: 30 g, duration 6 ms
- Bump: 10g, duration 6 ms

**Storage (Unpacked)**

- Temperature: –10 to +55°C
- Humidity: 10% to 95%
- Atmospheric Pressure: 700 to 1060 hPa

**Operation**

- Temperature: +10 to +40°C
- Relative Humidity: 30% to 90%, excluding condensation
- Atmospheric Pressure: 700 to 1060 hPa
- Altitude: Up to 3000 m above sea level
- Max. wet bulb: 78°F (26°C)



**WARNING: If any part of the system is reconfigured or replaced or if any external devices are connected to the instrument, the operator must ensure that the complete system continues to comply with the requirements defined in IEC 60601-1.**

### (A) Test Patterns & Parameters

This appendix describes the Threshold and Suprathreshold test parameters and test patterns.

#### Threshold Test Patterns

Default pattern is shown in bold.

Test Pattern	Extent of Visual Field Tested / Number of Points Tested	Application
Central 30-2	30 degrees/76 point grid	Glaucoma, retinal, neurological, general
<b>Central 24-2</b>	24 degrees/54 point grid	Glaucoma, general, neurological
Central 10-2	10 degrees/68 point grid	Macula, retinal, neurological, advanced glaucoma
Central 24-2C	24 degrees/64 point grid	Glaucoma, general, neurological
Peripheral 60-4	30 to 60 degrees/60 points	Retinal, glaucoma
Macula	5 degrees/16 points, 2 degrees spacing	Macula
Nasal Step	50 degrees/14 points	Glaucoma

Table A-1

#### Threshold Test Pattern Diagrams

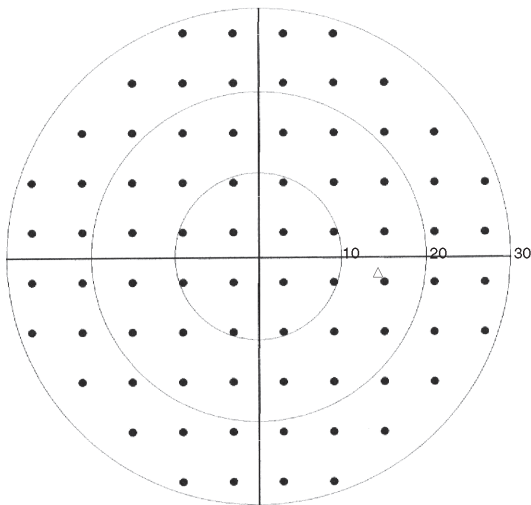

Figure A-1 Central 30-2 Test Pattern, Right Eye

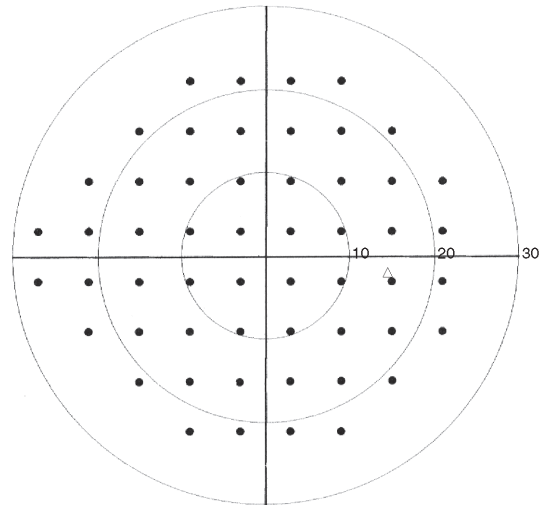

Figure A-2 Central 24-2 Test Pattern, Right Eye

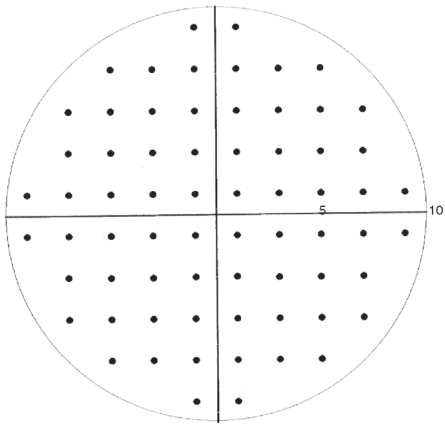

Figure A-3 Central 10-2 Test Pattern

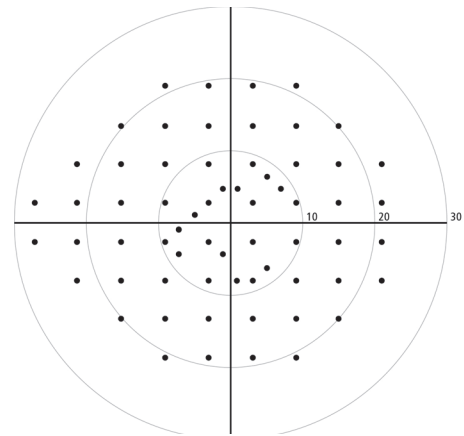

Figure A-4 Central 24-2C Test Pattern, Right Eye

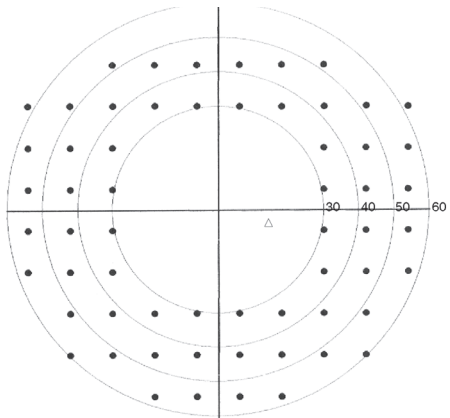

Figure A-5 Peripheral 60-4 Test Pattern, Right Eye

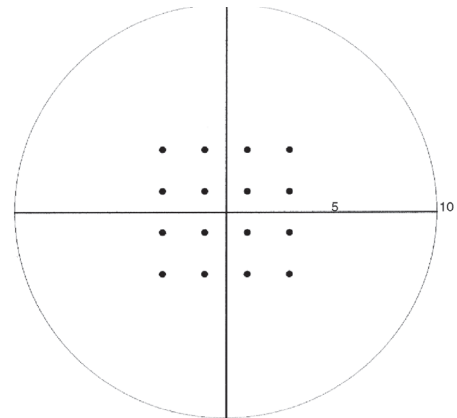

Figure A-6 Macula Test Pattern

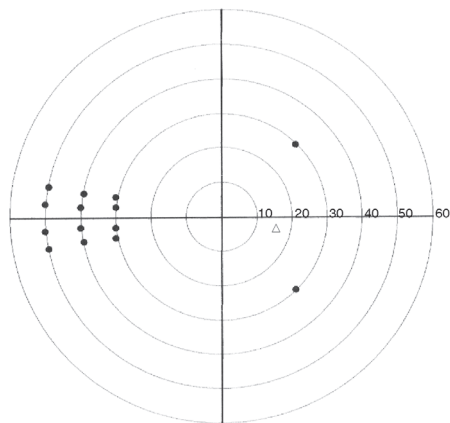

Figure A-7 Nasal Step Test Pattern, Right Eye

**Suprathreshold Test Patterns**

Default pattern is shown in bold.

Test Pattern	Extent of Visual Field Tested / Number of Points Tested	Application
Central 40 Point	30 degrees/40 points	General screening
Central 64 Point	30 degrees/64 points	General, glaucoma, neurological
<b>Central 76 Point</b>	30 degrees/76 points	General, glaucoma, neurological
Central 80 Point	30 degrees/ 80 points	General Screening
Armaly Central	30 degrees/84 points	Glaucoma
Nasal Step	50 degrees/14 points	Glaucoma
Peripheral 60 Point	30 to 60 degrees/60 points	General, neurological with central exam, retinal, glaucoma
Full Field 81 Point	55 degrees/81 points	General, retinal, glaucoma, neurological
Full Field 120 Point	55 degrees/120 points	General, retinal, glaucoma, neurological
Full Field 135 Point	87 degrees/135 points 87 degrees temporally	Full Field Screening
Full Field 246 Point	60 degrees/246 points	Full Field Screening
Armaly Full Field	50 degrees/98 points	Glaucoma
Superior 36 Point	60 degrees, superior hemifield/36 points	Superior Field Screening, Ptosis
Superior 64 Point	60 degrees, superior hemifield/64 points	Superior Field Screening, Ptosis
Esterman Monocular	75 degrees temporal 60 degrees nasal/100 points	Functional disability
Esterman Binocular	150 degrees bitemporal/ 120 points	Functional disability
Blindengeldgutachten	50 degrees/68 points	German Disability Test
Fuehrerscheingutachten	80 degrees temporal, 60 degrees nasal/105 points	German Drivers License Test

Table A-2

**Suprathreshold Test Pattern Diagrams**

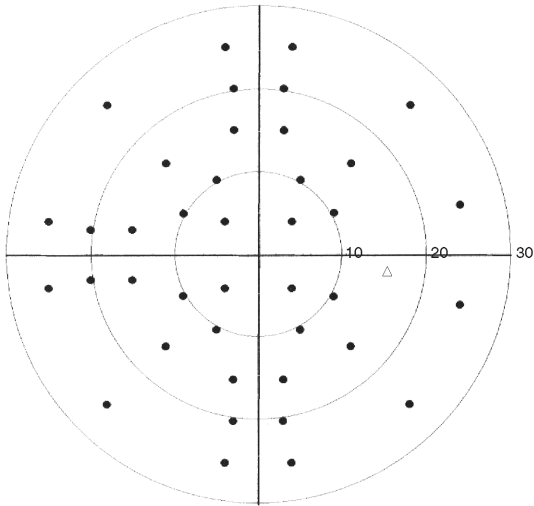

Figure A-8 Central 40-Point Test Pattern, Right Eye

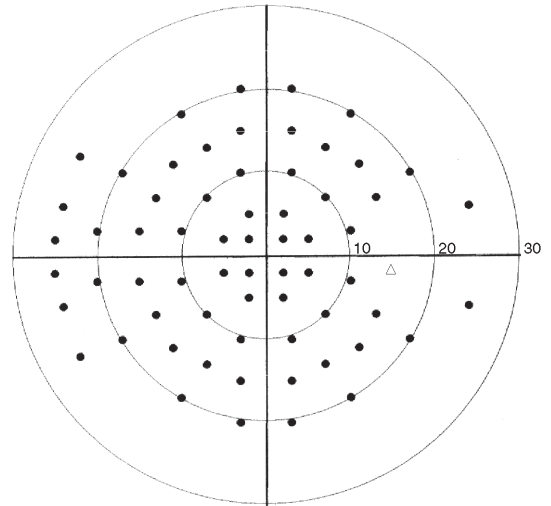

Figure A-9 Central 64-Point Test Pattern, Right Eye

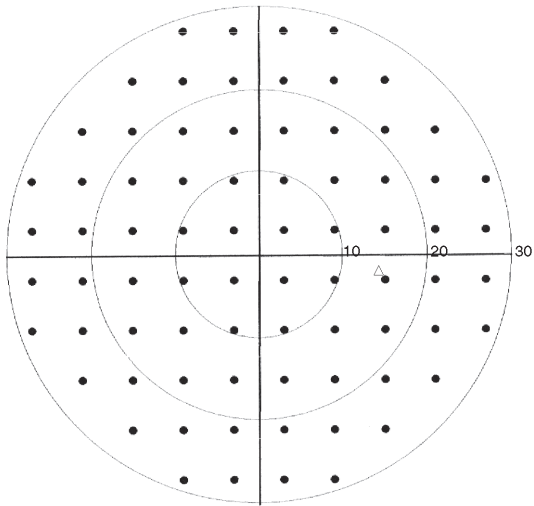

Figure A-10 Central 76-Point Test Pattern, Right Eye  
(This is the same pattern as the 30-2 Threshold test)

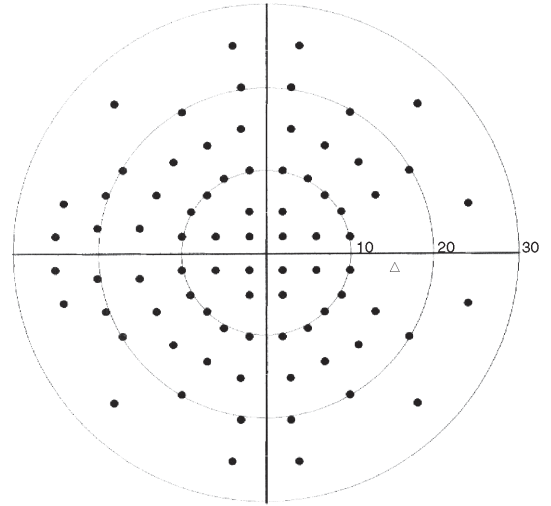

Figure A-11 Central 80-Point Test Pattern, Right Eye



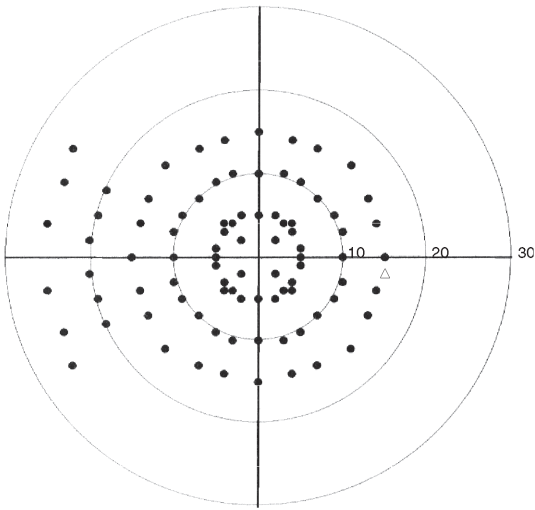

Figure A-12 Central Armaly Test Pattern, Right Eye

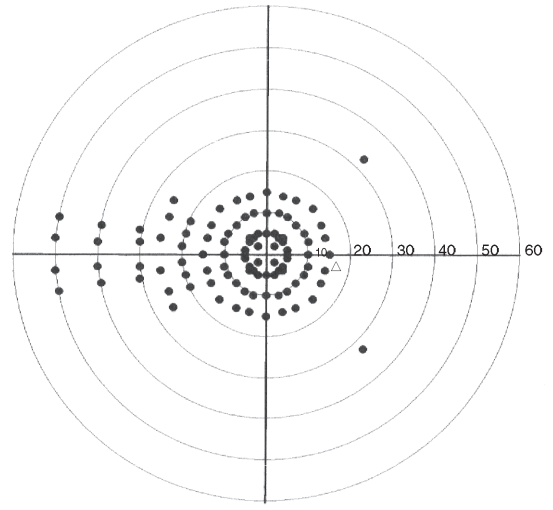

Figure A-13 Full Field Armaly Test Pattern, Right Eye

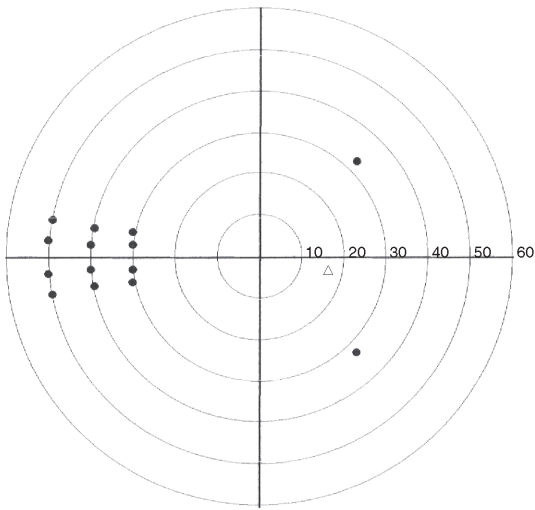

Figure A-14 Nasal Step Test Pattern, Right Eye

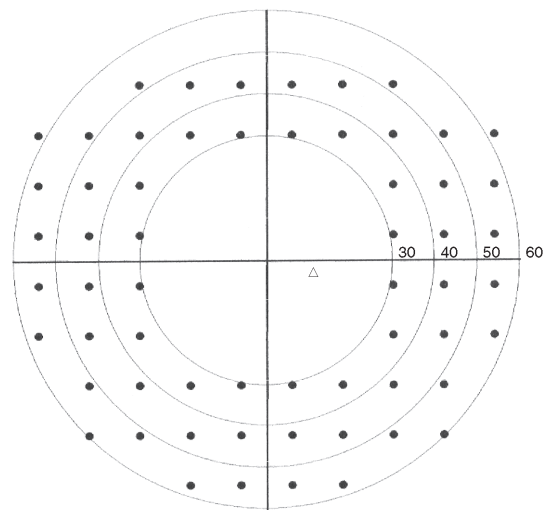

Figure A-15 Peripheral 60 Test Pattern, Right Eye

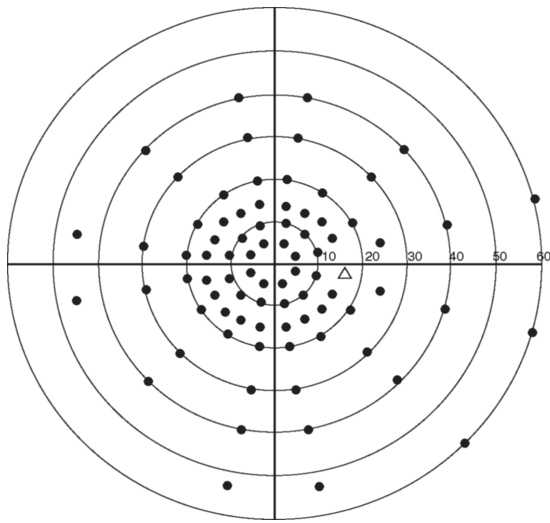

Figure A-16 Full Field 81 Test Pattern, Right Eye

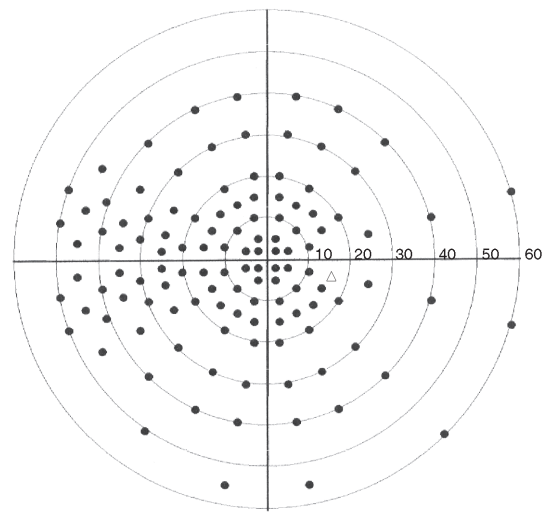

Figure A-17 Full Field 120 Test Pattern, Right Eye

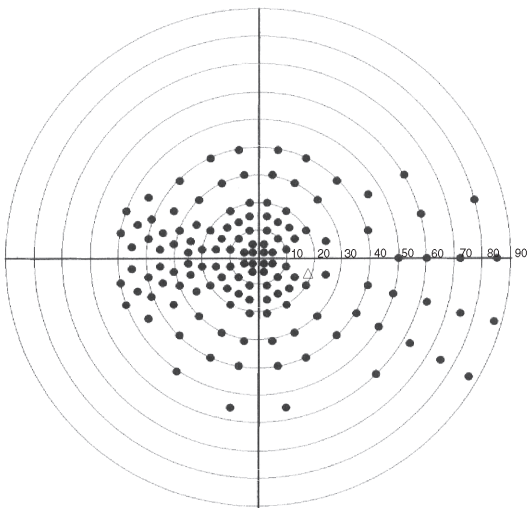

Figure A-18 Full Field 135 Test Pattern, Right Eye

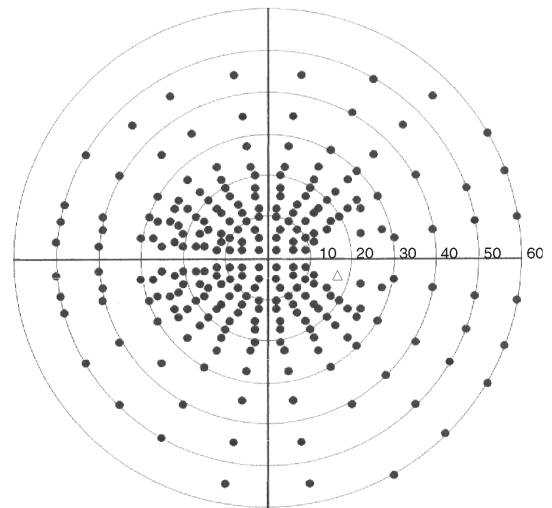

Figure A-19 Full Field 246 Test Pattern, Right Eye

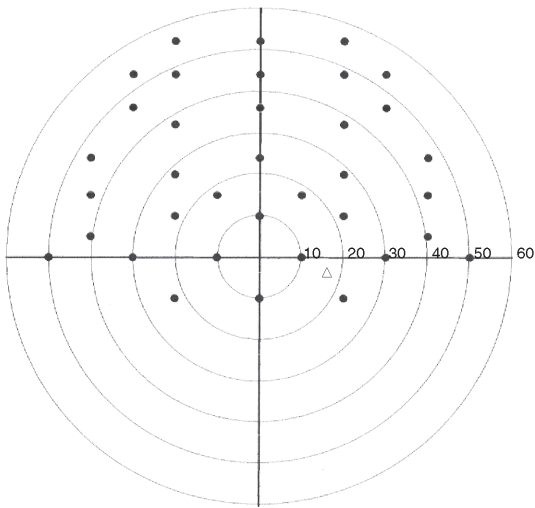

Figure A-20 Superior 36 Test Pattern, Right Eye

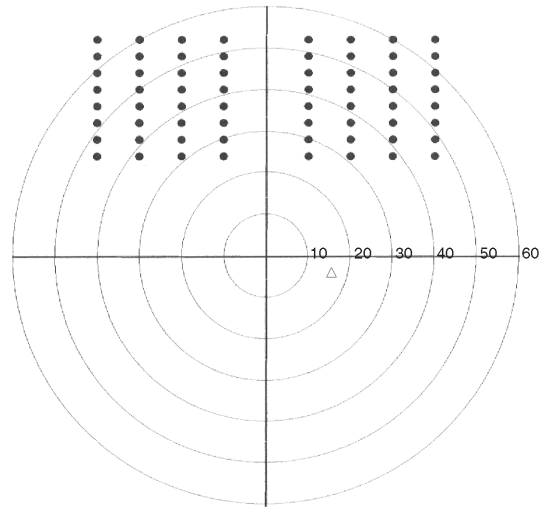

Figure A-21 Superior 64 Test Pattern, Right Eye

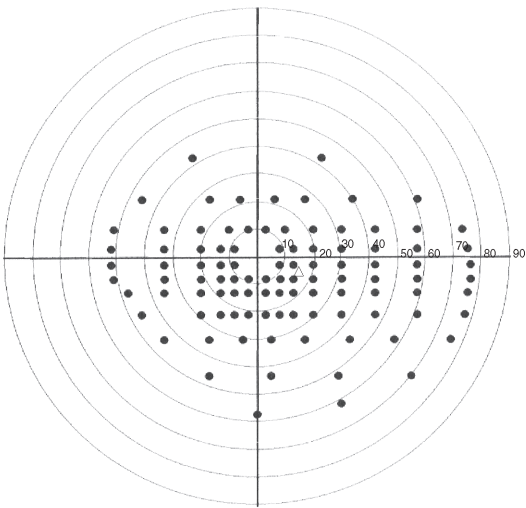

Figure A-22 Esterman Monocular Test Pattern, Right Eye

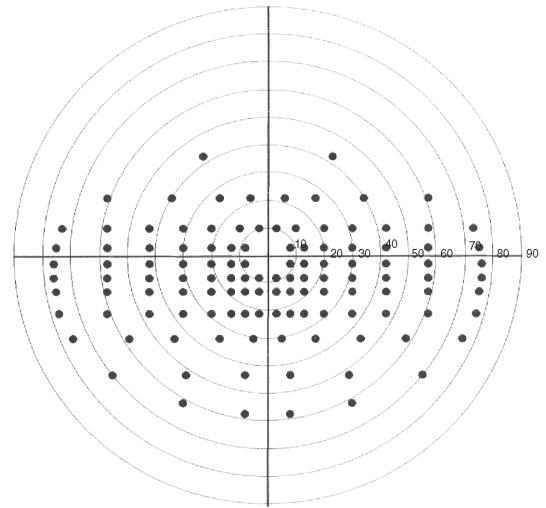

Figure A-23 Esterman Binocular Test Pattern

## Test Parameters

### Threshold Test Settings

The following table displays parameter settings available only when Static Threshold Testing is chosen. Default values are shown in bold.

Parameter	Parameter Settings	Description
Test Strategy	<b>SITA-Faster</b>	SITA Faster reduces test time approximately 30% faster than SITA Fast and 50% faster than SITA Standard for the same patient tests. It is available with the Central 24-2 pattern only. SITA Faster allows to add selected central locations back to the 24-2 test pattern to create an enhanced test pattern that can complete, on average, in the same time (or less) as a legacy 24-2 SITA Fast visual field. Resulting in a choice between running a quicker SITA Faster 24-2 visual field or a SITA Faster enhanced test pattern with the additional points. The Combined test pattern (24-2C) will be run using SITA Faster test strategy only.
	SITA-Fast	This is a faster version of SITA. SITA-Fast cuts testing time in half relative to the FastPac testing strategy, and is available for use with the Central 30-2, Central 24-2, Central 10-2, and Peripheral 60-4 test patterns.
	SITA-Standard	SITA-Standard cuts testing time in half relative to the Full Threshold strategy, and is available for use with the Central 30-2, Central 24-2, Central 10-2, and Peripheral 60-4 test patterns.
	SITA-SWAP (Models 850 and 860)	This strategy uses SITA with Blue-Yellow testing (see page A-9). SITA-SWAP testing is only available for use with the Central 24-2 test pattern.
	Full Threshold	The test strategy used prior to the adoption of SITA. Use with all Threshold test patterns. In Full Threshold testing, an initial stimulus is presented at a level the patient is expected to see. If seen, the stimulus intensity is decreased in 4 dB steps (0.4 log units) until the patient no longer sees the stimulus; if not seen, it is increased in 4 dB steps until seen. The instrument then changes direction, moving in 2 dB steps until a change in patient response occurs. The last stimulus seen by the patient is recognized as the threshold for that point.
	FastPac	FastPac is similar to the Full Threshold strategy, but decreases test time by about 40%. Use with all Threshold test patterns. It follows a similar stair-stepping technique as in Full Threshold, but uses 3 dB increments instead of 4 dB and crosses the threshold only once.
Foveal Threshold (Models 840, 850, and 860)	<b>Off</b>	A threshold value for the fovea will not be measured.
	On	A threshold value for the fovea will be determined at the beginning of the test. The foveal threshold test presents stimuli inside the Small Diamond fixation target; the Small Diamond will automatically be illuminated.
Fluctuation	<b>Off</b>	Threshold values for preselected points will not be determined twice. Some points may be retested even if fluctuation is turned off.
	On	Threshold values for ten (10) preselected points are retested to determine the variability of the patient's responses. Threshold values for the retested points are printed on the numeric printout and appear in parentheses directly below the first test result. Fluctuation values which differ significantly from normal are flagged with appropriate "p" (probability) values. Available for Full Threshold and FastPac tests only.

Table A-3

**Suprathreshold Test Settings**

The following table displays parameter settings available only when Suprathreshold Testing is chosen. Default values are shown in bold.

Parameter	Parameter Settings	Description
Test Strategy	<b>Two Zone</b>	For each point in the test pattern, a stimulus is presented 6 dB brighter than the expected threshold. Since testing is done with an intensity 6 dB brighter than the expected threshold, Points Not Seen are known to be at least 6 dB deep. Use with all Suprathreshold test patterns. Esterman tests use only the Two Zone test strategy.
	Three Zone	Same as Two Zone, except each missed point is measured again at a maximum intensity of 10,000 apostilbs (0 dB) to determine if the defect is absolute. Use with all Suprathreshold test patterns except the Esterman tests.
	Quantify Defects	Same as Two Zone, except the sensitivity at each missed point is measured relative to the expected threshold. Use with all Suprathreshold test patterns except the Esterman tests.
Test Mode	<b>Age Corrected</b>	Vision is most acute at the fovea and decreases toward the periphery of the retina resulting in a hill of vision with the peak occurring at the fovea. A hill of vision is assigned to the patient based on the patient's age. Age Corrected mode is used only with Size III, White stimuli, and can be used with all Suprathreshold test patterns except the Esterman tests.
	Threshold Related	A hill of vision is assigned only after threshold values for 4 primary points are determined. Use with all Suprathreshold test patterns except the Esterman tests.
	Single Intensity	Available only with the Two Zone test strategy. Esterman tests use only the Single Intensity test mode. The HFA uses a default intensity level of 10 dB to test the entire visual field. The default can be changed except with the Esterman tests.

Table A-4

**Shared Settings**

The following table displays parameter settings available for both Static Threshold and Suprathreshold testing. Default values are shown in bold.

Parameter	Parameter Settings	Description
Blue-Yellow/Short-Wave length Automated Perimetry or SWAP (Models 850 and 860)	<b>Off/On</b>	Blue-Yellow testing uses a blue stimulus presented on a yellow background.
Stimulus Color	<b>White</b> (all models)	White stimulus projected onto white bowl background. White is used only for the SITA-Standard, SITA-Fast, and Suprathreshold Age Corrected test strategies, as well as the Esterman test patterns.
	Red (Models 840, 850, and 860)	Red stimulus projected onto white bowl background.
	Blue (Models 850 and 860)	Blue stimulus projected onto white bowl background. Background is yellow, if Blue-Yellow is <b>On</b> .
Stimulus Size	I, II, <b>III</b> , IV, V	Five stimulus sizes (diameters) are available, ranging from Size I (smallest) to Size V (largest). SITA-Standard, SITA-Fast, and Suprathreshold Age Corrected test strategies, as well as the Esterman test patterns use only Size III. SITA-SWAP uses only Size V.
Fixation Monitoring	<b>Gaze/Blind Spot</b>	The Blind Spot and Gaze Tracking system are both activated.

Table A-5

Parameter	Parameter Settings	Description
	Gaze Tracking (Models 840, 850, and 860)	The Gaze Tracking system automatically measures gaze direction at the time of stimulus presentation. <b>Note:</b> Gaze Tracking is the default for SITA Faster.
	Blind Spot	The test program periodically presents a stimulus in the patient's blind spot. If the patient is fixating well, he or she should not see the blind spot check stimulus. The blind spot check stimulus always matches the test stimulus size.
	Off	Disables all fixation monitoring. The operator should monitor fixation with the video eye monitor.
Fixation Target	<b>Central</b>	Yellow light in the center of the bowl. This is the only option available for the Threshold Peripheral 60-4, and the Suprathreshold Esterman tests.
	Small Diamond	The Small Diamond is located below the Central target, and should be used when a patient cannot see the central fixation light (e.g. macular degeneration). The patient should look in the center of the diamond formed by the four lights.
	Large Diamond	The Large Diamond is located below the Central target and is useful for patients with central scotoma who cannot see either the Central fixation light or the Small Diamond.
	Bottom LED	Some tests have points in the superior visual field that require a lower fixation light than the central target. The target used is the Bottom LED of the Large Diamond. When testing with the Superior 64 or Superior 36 Suprathreshold tests, the Bottom LED is the default fixation target. It is illuminated automatically at the start of a test.
Test Speed	<b>Normal</b>	Two stimulus presentation speeds are available.
	Slow	The test speed may be changed while a test is in progress to allow the patient some additional time to respond.

Table A-5

## (B) Determine Trial Lens

If you are not using the automatic trial lens calculation refer to the following guidelines for selecting manual trial lenses.

### Guidelines for Trial Lens Selection

1. Ignore cylinders of 0.25 D or less.
2. For cylinder errors of up to 1.75 D use the spherical equivalent. Use the full cylinder correction for cylinder errors of 1.75 D or more.
3. Refer to [Table B-1](#) for hyperopic or emmetropic patients, or [Table B-2](#) for myopic patients, to determine the power of the spherical trial lens needed.
4. Verify that the patient can see the fixation light clearly through the trial lens before beginning testing. Young myopes may need additional minus power if the target appears blurry to them, prior to beginning testing. Many 30–40 year olds may not need the full trial lens correction.

### How to Calculate the Spherical Equivalent

The spherical equivalent is equal to half of the power of the cylinder (DC) correction. For example, the spherical equivalent of +1.00 DC is +0.50 D. The spherical equivalent of –0.50 DC is –0.25 D. Add the spherical equivalent of the cylinder power to the original spherical power to get the overall spherical equivalent.

Age	Hyperopic Distance R <sub>x</sub> is Greater than Zero	Emmetropic Distance R <sub>x</sub> is Zero (Plano)
Under 30	Distance R <sub>x</sub> only	No correction
30–39	(Dist. R <sub>x</sub> ) + (1.00 D) = trial lens	+1.00 D trial lens
40–44	(Dist. R <sub>x</sub> ) + (1.50 D) = trial lens	+1.50 D trial lens
45–49	(Dist. R <sub>x</sub> ) + (2.00 D) = trial lens	+2.00 D trial lens
50–54	(Dist. R <sub>x</sub> ) + (2.50 D) = trial lens	+2.50 D trial lens
55–59	(Dist. R <sub>x</sub> ) + (3.00 D) = trial lens	+3.00 D trial lens
60 & Over	(Dist. R <sub>x</sub> ) + (3.25 D) = trial lens	+3.25 D trial lens

**Table B-1 Spherical Trial Lens Correction for Central Visual Field Testing of Hyperopic and Emmetropic Patients**

Age	Distance R <sub>x</sub> — 0.50	Distance R <sub>x</sub> —1.00	Distance R <sub>x</sub> —1.50	Distance R <sub>x</sub> —2.00	Distance R <sub>x</sub> —2.50	Distance R <sub>x</sub> —3.00	Distance R <sub>x</sub> over —3.00
Under 30	No trial lens needed	No trial lens needed	No trial lens needed	No trial lens needed	No trial lens needed	No trial lens needed	(Dist. R <sub>x</sub> ) + (+3.25 D) for trial lens
30–39	+0.50 D	No trial lens needed	No trial lens needed	No trial lens needed	No trial lens needed	No trial lens needed	(Dist. R <sub>x</sub> ) + (+3.25 D) for trial lens
40–44	+1.00 D	+0.50 D	No trial lens needed	No trial lens needed	No trial lens needed	No trial lens needed	(Dist. R <sub>x</sub> ) + (+3.25 D) for trial lens
45–49	+1.50 D	+1.00 D	+0.50 D	No trial lens needed	No trial lens needed	No trial lens needed	(Dist. R <sub>x</sub> ) + (+3.25 D) for trial lens
50–54	+2.00 D	+1.50 D	+1.00 D	+0.50 D	No trial lens needed	No trial lens needed	(Dist. R <sub>x</sub> ) + (+3.25 D) for trial lens
55–59	+2.50 D	+2.00 D	+1.50 D	+1.00 D	+0.50 D	No trial lens needed	(Dist. R <sub>x</sub> ) + (+3.25 D) for trial lens
60 & Over	+2.75 D	+2.25 D	+1.75 D	+1.25 D	+0.75 D	No trial lens needed	(Dist. R <sub>x</sub> ) + (+3.25 D) for trial lens

Table B-2 Spherical Trial Lens Correction for Central Visual Field Testing of Myopic Patients



Note: If the patient is aphakic or needs a high refractive power such as +8.00 D, contact lenses may provide the best visual field testing conditions.



## (C) Troubleshooting

In the case of malfunction, error messages or operational problems, call ZEISS Customer Care: In the U.S., call 800-341-6968. Outside the U.S., contact your local ZEISS distributor. Know the HFA3 model, serial number, and current software revision before calling Customer Service.

The HFA3 model and serial numbers are found on the rear panel of the instrument. Software revision is located under "System Information," on page 3-10. To provide a copy of the log files see "Networking," on page 3-19.

Record these numbers here for future reference:

Model Number: \_\_\_\_\_

Serial Number: \_\_\_\_\_

### Error Alerts

Error messages will appear on the HFA3 in response to certain issues. Follow the directions stated in the alert text.

Alert Title	Alert Text
System Initialization Not Completed.	An unexpected error occurred during initialization. Reboot device, if problem persists service may be required.
	Instrument may need calibration. Reboot device, if problem persists service may be required.
	Bowl light is too high. Please dim room lights and retry.
	Aperture alignment check failed. Reboot device, if problem persists service may be required.
	Required projector lamp intensity could not be achieved. Power down device and replace projection lamp, if problem persists service may be required.
	Projector lamp unplugged. Power down device and ensure projector lamp connection is secure. If problem persists, service may be required.
	Shutter alignment check failed. Reboot device, if problem persists service may be required.
	Calibration data error. Reboot device, if problem persists service may be required.

Table C-1

Alert Title	Alert Text
Test Failed	System Encountered a Serious Error. Reboot device, if problem persists service may be required.
	Failed to Run Kinetic Test. You may retry the test and/or reboot device. If problem persists service may be required.
	Failed to Initialize Kinetic Test. You may retry the test and/or reboot device. If problem persists service may be required.
	Failed to Initialize Isopter. You may retry the test and/or reboot device. If problem persists service may be required.
	Failed to run a scan. You may retry the test and/or reboot device. If problem persists service may be required.
	Patient switch unplugged. Verify switch is properly connected and reboot device. If problem persists service may be required.
	Patient switch not functioning. Replace patient switch.
Test Initialization Failed	An error occurred while preparing for test. You may retry the test and/or reboot device. If problem persists service may be required.
	Ambient light is too high. Please dim room lights and retry.
TLC (Trial Lens Correction) Error	TLC is not fully inserted. Please remove and re-insert the TLC again.
	Manual TLC unspecified error. Please remove and re-insert the Manual TLC again.
	TLC is not functioning. Please remove the TLC and use a different trial lens holder.
	Auto TLC unspecified error. Please remove and re-insert the Auto TLC again.
	TLC unspecified error. Please remove and re-insert the TLC again.

Table C-1

**Troubleshooting Table**

Not all potential situations are listed in **Table C-2**, nor are all of the possible solutions.

**Table C-2**

Startup Difficulties	
HFA3 will not turn on.	<ul style="list-style-type: none"> <li>• Check power cord connections to HFA3 and wall outlet.</li> <li>• Check power switch on optional power table.</li> </ul>
HFA3 turns on but initial screen never appears.	<ul style="list-style-type: none"> <li>• Call Customer Service and mention the error code.</li> </ul>
Touch Screen	
Wrong button activated when pressed.	<ul style="list-style-type: none"> <li>• Make sure finger is perpendicular to the touch screen.</li> </ul>
Patient Response Button	
Does not beep when pressed.	<ul style="list-style-type: none"> <li>• Check patient response button connection to HFA3.</li> <li>• Verify patient is properly pressing and releasing response button.</li> </ul>
Time and Date	
Time/date display on screen is incorrect.	<ul style="list-style-type: none"> <li>• Correct by changing time and date under <a href="#">“General Settings,”</a> on page 3-11.</li> </ul>
Printer	
Does not print.	<ul style="list-style-type: none"> <li>• No power to printer (no lights visible on front panel). <ul style="list-style-type: none"> <li>- Check to ensure power cord is attached and check power switch.</li> </ul> </li> <li>• No paper in printer.</li> </ul>
No signal from HFA3.	<ul style="list-style-type: none"> <li>• Check printer cable connection.</li> <li>• Check cable is correct and not damaged.</li> <li>• Check to ensure correct printer is selected under <a href="#">“General Settings,”</a> on page 3-11.</li> <li>• No printout selected to print.</li> <li>• Consult specific printer manuals.</li> </ul>
Improper printout.	<ul style="list-style-type: none"> <li>• Random characters or multiple pages printed. <ul style="list-style-type: none"> <li>- Check to ensure correct printer is selected under <a href="#">“General Settings,”</a> on page 3-11.</li> </ul> </li> </ul>
System hangs during printer configuration.	<ul style="list-style-type: none"> <li>• Invalid printer name or IP address entered. <ul style="list-style-type: none"> <li>- Press the <b>Esc</b> button on the keyboard to exit the locked printer setup screen or restart the instrument. Enter a valid printer name and/or IP address.</li> </ul> </li> <li>• Editing printer settings particularly if the printer has documents in the queue. <ul style="list-style-type: none"> <li>- Restart the instrument. To edit a printer, create a new printer and use the IP address of the existing printer. You may then delete the old printer.</li> </ul> </li> </ul>
New printer cannot be set up.	<ul style="list-style-type: none"> <li>• Occurs if you are using the same name as a deleted printer. Deleting a printer does not always delete the port it used. <ul style="list-style-type: none"> <li>- Use another printer name or manually delete the port in Windows.</li> </ul> </li> </ul>
Failed Wireless Communication	
Failed Wireless Communication	<ul style="list-style-type: none"> <li>• Restart the printer.</li> <li>• Connect printer with network cable instead of wireless.</li> <li>• Replace the DLINK Wireless Adapter.</li> <li>• Replace the printer.</li> </ul>
Report Problems	
No SFA report.	<ul style="list-style-type: none"> <li>• Test pattern not eligible for STATPAC analysis.</li> <li>• One or more test parameters not valid for STATPAC.</li> </ul>
Quad totals not shown.	<ul style="list-style-type: none"> <li>• Available on Three in One printout only.</li> </ul>
No SF or CPSD values on threshold report.	<ul style="list-style-type: none"> <li>• SF and CPSD are not displayed when SITA test strategy is used.</li> <li>• Fluctuation was turned off for the test (CPSD is not calculated when fluctuation is off).</li> </ul>
Glaucoma Hemifield Test (GHT) results not displayed.	<ul style="list-style-type: none"> <li>• FastPac test strategy used (GHT not available with FastPac).</li> <li>• Test not eligible for STATPAC analysis.</li> </ul>
Report does not include all eligible tests for a patient when printing Overview or GPA printout.	<ul style="list-style-type: none"> <li>• Some test parameters not valid for STATPAC or GPA.</li> <li>• Patient name or date of birth incorrect on some tests. Correct patient data.</li> </ul>

Table C-2

Inconsistent labeling on the SFA GPA report.	<ul style="list-style-type: none"> <li>Only occurs on 30-2 tests generated on the HFA3. If GPA analysis is based on prior 24-2 tests, pattern label for the Progression Analysis Probability Plot should be 24-2 but is displayed as 30-2.</li> </ul>
<b>Blind Spot Monitor</b>	
Cannot change Blind Spot size.	<ul style="list-style-type: none"> <li>HFA3 uses same stimulus size for testing and Blind Spot check.</li> </ul>
Cannot locate blind spot.	<ul style="list-style-type: none"> <li>Realign patient.</li> <li>Verify that proper eye is being tested.</li> <li>Check to make sure the patient's non-testing eye is occluded.</li> <li>Make sure patient is fixating on fixation light.</li> <li>Select <b>Restart</b> in the Gaze Initialization box to restart the test.</li> <li>Turn off Blind Spot Monitoring.</li> </ul>
<b>Gaze Tracking</b>	
Gaze Tracking will not initialize.	<ul style="list-style-type: none"> <li>HFA3 is Model 830.</li> <li>Make sure that three distinct corneal reflections are visible when using no lenses or a manual trial lens. Two reflections should be visible with the Liquid Trial Lens.</li> <li>Make sure that the center of the pupil is aligned with the monitor or the center of the lens and that the edges of the pupil are clearly visible.</li> <li>Avoid spurious reflections near the pupil by adjusting patient alignment and/or trial lens.</li> <li>High power trial lens being used may cause large corneal reflections. Try moving the lens away from the eye by 3mm. To avoid trial lens artifacts do not move too far back.</li> <li>Droopy eyelid - ask patient to open eye wider during initialization.</li> <li>Interfering eyelashes - ask patient to open eye wider during initialization.</li> <li>Small pupils.</li> <li>Excessive eye movement or blinking.</li> <li>Excessively large or dilated pupils.</li> <li>Dry eyes, cloudy media or dark iris.</li> <li>Deep-set eyes.</li> </ul>
Large Gaze Tracking errors or Not Detected marks.	<ul style="list-style-type: none"> <li>Gaze errors on the HFA3 graph look larger than those on older HFA models.</li> <li>Patient not fixated properly at the central location during gaze initialization.</li> <li>Eye position has drifted away from the original position. Realign the patient.</li> <li>Make sure that three distinct corneal reflections are visible when using no lenses or a manual trial lens. Two reflections should be visible with the Liquid Trial Lens.</li> <li>Make sure that the center of the pupil is aligned with the monitor or the center of the lens and that the edges of the pupil are clearly visible.</li> <li>Avoid spurious reflections near the pupil by adjusting patient alignment and/or trial lens.</li> <li>Droopy eyelid - ask patient to open eye wider.</li> <li>Interfering eyelashes - ask patient to open eye wider.</li> <li>Small pupils.</li> <li>Excessive eye movement or blinking.</li> <li>Excessively large or dilated pupils.</li> <li>Dry eyes, cloudy media or dark iris.</li> <li>Deep-set eyes.</li> </ul>
<b>Head Tracking</b>	
Head Tracking does not work.	<ul style="list-style-type: none"> <li>HFA3 not Models 840, 850, or 860.</li> <li>Head Tracking not turned on.</li> <li>Trial lens holder not in up position.</li> <li>Gaze Tracking was not initialized at the start of the test.</li> </ul>
Head Tracking alarm activates too often.	<ul style="list-style-type: none"> <li>Patient's chin not moving with the chin rest - re-instruct patient.</li> <li>Reset Head Tracking.</li> <li>Turn off Head Tracking.</li> </ul>

Table C-2

Vertex Monitoring	
Vertex Monitoring does not work.	<ul style="list-style-type: none"> <li>• HFA3 not Models 850 or 860.</li> <li>• Vertex Monitoring not turned on.</li> <li>• Trial lens holder not in up position.</li> <li>• Gaze Tracking was not initialized at the start of the test.</li> </ul>
Vertex Monitoring alarm beep goes off too often.	<ul style="list-style-type: none"> <li>• Patient moving away from trial lens - reposition patient.</li> <li>• Vertex Monitoring needs to be reset.</li> <li>• Turn off Vertex Monitoring.</li> </ul>
Pupil Size	
Not being automatically displayed on printout or on screen.	<ul style="list-style-type: none"> <li>• HFA3 not Models 840, 850, or 860.</li> <li>• Gaze Tracking was not initialized.</li> <li>• Auto pupil turned off.</li> </ul>
Liquid Trial Lens	
Error messages occurring.	<ul style="list-style-type: none"> <li>• Do not move the Liquid Trial Lens when it is being adjusted (icon flashing red). <ul style="list-style-type: none"> <li>- To resolve error messages, lower then raise the lens. If errors persist, remove the Liquid Trial Lens holder completely and then reattach it.</li> </ul> </li> </ul>
External Keyboard	
Does not work.	<ul style="list-style-type: none"> <li>• May not be compatible with HFA3. <ul style="list-style-type: none"> <li>- Try another keyboard.</li> </ul> </li> <li>• Not plugged in properly.</li> </ul>
Trackpad, Trackball or Mouse	
Does not work.	<ul style="list-style-type: none"> <li>• May not be compatible with HFA3. <ul style="list-style-type: none"> <li>- Try a different trackball/mouse.</li> </ul> </li> </ul>
SWAP (Short-Wavelength Automated Perimetry)	
SITA-SWAP not available with Blue-Yellow switched to on.	<ul style="list-style-type: none"> <li>• Wrong test pattern used. <ul style="list-style-type: none"> <li>- Choose a 24-2 Threshold test, then turn Blue-Yellow on.</li> </ul> </li> </ul>
Grayscale looks very dark.	<ul style="list-style-type: none"> <li>• May be normal for Blue-Yellow. The eye is less sensitive to the blue stimulus. <ul style="list-style-type: none"> <li>- Gray scale is the same one used for White-on-White.</li> <li>- Use Total and Pattern Deviation plots for diagnosis.</li> </ul> </li> <li>• Patient had difficult time recognizing when to respond. <ul style="list-style-type: none"> <li>- Re-instruct the patient and repeat the test.</li> </ul> </li> </ul>
Blind spot monitor reports many Fixation Losses.	<ul style="list-style-type: none"> <li>• Size V blind spot check size may be too easy to see at blind spot. <ul style="list-style-type: none"> <li>- Consider using Gaze Track only and turn off Blind Spot.</li> </ul> </li> </ul>
Blue stimulus is on but bowl is not yellow.	<ul style="list-style-type: none"> <li>• Blue stimulus color was chosen instead of Blue-Yellow parameter. <ul style="list-style-type: none"> <li>- Blue Yellow parameter set to <b>On</b> will give yellow bowl and Blue Size V stimulus.</li> </ul> </li> </ul>
Illumination from yellow lamp at top of bowl annoying to patient.	<ul style="list-style-type: none"> <li>• Visor not extended during testing procedure.</li> </ul>
Testing Problems	
Test completes immediately after <b>Start</b> button is pressed.	<ul style="list-style-type: none"> <li>• Simulation Mode is on. <ul style="list-style-type: none"> <li>- Turn Simulation Mode off.</li> </ul> </li> </ul>
Full field test stops before complete.	<ul style="list-style-type: none"> <li>• Trial lens holder in up position for peripheral portion of test. <ul style="list-style-type: none"> <li>- Test peripheral field without a trial lens and put holder down.</li> </ul> </li> </ul>
Hard Disk Problems	
Message indicates hard disk failure.	<ul style="list-style-type: none"> <li>• Call Customer Service and mention the error code.</li> </ul>
Patient names exist in database without test data.	<ul style="list-style-type: none"> <li>• Test results not saved with patient information. <ul style="list-style-type: none"> <li>- Delete patient record.</li> </ul> </li> </ul>

Table C-2

USB Media Problems	
USB device does not show up on the HFA3, or a USB media error is indicated.	<ul style="list-style-type: none"> <li>The USB device may be incompatible with the HFA.</li> </ul>
Data Transfer Problems	
Transfer of files from HFA II/HFA II - i to HFA3 via serial cable does not work.	<ul style="list-style-type: none"> <li>Check cable attachments.</li> <li>RS-232 port settings are incorrect.</li> </ul>
Tests missing after data transfer.	<ul style="list-style-type: none"> <li>Tests were ineligible to be transferred. See <a href="#">"Set Up a Serial Transfer from an HFA II or HFA II-i,"</a> on page 9-1.</li> </ul>
Data transfer to file server does not work.	<ul style="list-style-type: none"> <li>Transfer fails due to network error.               <ul style="list-style-type: none"> <li>Re-establish the connection. Interrupted data transfer should restart. To print reports when disconnected from the file server, print reports directly from the instrument.</li> </ul> </li> </ul>
Routine Cleaning	
Air Intake Filter.	<ul style="list-style-type: none"> <li>Clean every 3 months or when dirty.</li> </ul>
Cleaning other components.	<ul style="list-style-type: none"> <li>See <a href="#">Chapter (8), "Maintenance"</a>.</li> </ul>

## **(D) Legal Notices**

### **Software Copyright**

The software program ("Software") included with your HFA3 is a proprietary product of ZEISS and in certain instances contains material proprietary to Microsoft Corporation and other third-party licensors, suppliers and vendors. These proprietary products are protected by copyright laws and international treaty. You must treat the software like any other copyrighted material. Copyright ©2017 Carl Zeiss Meditec, Inc. All rights reserved.

### **End User Software License Agreement**

This End User Software License Agreement ("Agreement") is a legal contract between the Purchaser ("You", "Your" "Licensee") and ZEISS governing Your use of the Software. Opening the sealed package indicates Your acceptance of the terms and conditions of this License. If You have any questions concerning this License, contact Carl Zeiss Meditec, Attention Customer Service, 5160 Hacienda Drive, Dublin, CA 94568. Telephone 800-341-6968.

### **License Terms and Conditions**

This End User Software License Agreement ("**Agreement**") is between you (both the individual installing the Software and any single legal entity on behalf of which such individual is acting) ("**You**" or "**Your**") and Carl Zeiss Meditec, Inc. ("**ZEISS**").

BY INSTALLING NEW SOFTWARE ON YOUR EXISTING HFA3, OR BY CREATING DATA ON A NEW HFA3 THAT ALREADY CONTAINS NEW SOFTWARE, YOU ALSO AGREE TO BE BOUND BY THIS AGREEMENT. IF YOU DO NOT AGREE WITH ALL THE TERMS OF THIS AGREEMENT AND DO NOT AGREE TO BE BOUND BY THIS AGREEMENT, THEN DO NOT INSTALL NEW SOFTWARE ON ANY EXISTING HFA3 YOU MAY OWN, NOR OPERATE ANY NEW HFA3 YOU MAY OWN THAT ALREADY CONTAINS NEW SOFTWARE. IF YOU DO NOT ACCEPT THIS AGREEMENT, YOU WILL NOT HAVE THE RIGHT TO USE OR ACCESS THE PROGRAMS.

In consideration of the mutual promises contained herein, and other good and valuable consideration, the receipt and adequacy of which are hereby acknowledged by each party, the parties mutually agreed as follows:

#### **1. DEFINITIONS**

1.1 "**Documentation**" means the user guides for installation and use of the Software (including read-me files, notice files, and installation details) or the hardware on which the Software operates.

1.2 "**Software**" means the software provided by ZEISS and ZEISS' third party licensors ("**Third Party Licensors**") for use in connection with HFA3, in object code form or, only if provided as part of the Third Party Licensor's standard shipment of the Software in source code form, including any operating systems and integrated software, and the media, Documentation and any updates and upgrades provided by ZEISS or the Third Party Licensors to which You are granted a license from ZEISS pursuant to this Agreement.

## 2. SOFTWARE LICENSE

2.1 **Limited License.** Provided that You comply with the restrictions set forth herein, ZEISS hereby grants to You a limited, non-exclusive, non-transferable license (without the right to sublicense) (the “**Limited License**”) to:

(a) use a single copy of the Software on, solely in conjunction with the applicable software package and for Your own internal business operations on the HFA3 on which the Software was first installed for production operation or, on a temporary basis, on a backup system if such equipment is inoperative, consistent with the limitations specified or referenced in this Agreement and the Documentation. If the HFA3 on which You use the Software is a multi-user system, this Limited License covers all users on that single system; and

(b) use the Documentation provided with the Software in support of Your authorized use of the Software.

2.2 **Restrictions.** You will not, and will not permit any third party to, copy or use the Software (including the Documentation) except as expressly permitted by this Agreement. In addition, You will not, and will not permit any third party to:

(a) Relicense, sublicense, rent or lease the Software or use the Software for rental, timesharing, subscription service, hosting or outsourcing;

(b) Modify, reverse engineer (except to the extent expressly permitted by applicable law, and then only after You have notified ZEISS in writing of Your intended activities), disassemble or decompile the Software, including, but not limited to, review of data structures or similar materials produced by the Software;

(c) Copy the Software;

(d) Assign, give or transfer the Software to any third party except as expressly permitted by Section 7.4, and You agree that in the event You grant a security interest in the Software, the secured party will have no right to use or transfer to Software;

(e) Remove or modify any Software markings (or any markings from the hardware on which the Software operates), or any notice of ZEISS or Third Party Licensors’ proprietary rights;

(f) Publish the results of any benchmark tests performed on the Software or the hardware on which the Software operates; or

(g) Use any source code that is provided with the Software.

2.3 **Ownership.** ZEISS or its licensors, suppliers and vendors (“**Third Party Licensors**”) will retain all right, title and interest in and to the patent, copyright, trademark, trade secret and any other intellectual property rights in the Software and any derivative works thereof, subject only to the Limited Licenses granted in this Agreement. Notwithstanding the foregoing, You acknowledge that the printing of ZEISS’ trademarks on output produced by the Software does not give rise to any rights in ZEISS’ trademarks in You. You do not acquire any rights, express or implied, in the Software other than those rights expressly granted under this Agreement. You will retain all right, title and interest in and to data created by Your operation of the Software (“**Data**”) except as



otherwise agreed to in writing between You and ZEISS. You (a) will provide ZEISS with access to such Data and (b) hereby grant and will grant to ZEISS the right to use such Data, in each case (a) and (b) solely for the purpose of providing maintenance and support services in connection with the Software. For the avoidance of doubt, You own the physical media, HFA3, on which the Software is originally or subsequently recorded or fixed, but You understand and agree that ZEISS and Third Party Licensors retain title and ownership to the Software and all subsequent copies Software thereof.

**2.4 No Support.** ZEISS has no obligation to provide support, maintenance, corrective updates, upgrades, modifications or new releases of the Software under this Agreement. ZEISS may create updated or upgraded versions of the Software, which You may purchase separately.

**2.5 No Obligations.** Third Party Licensors are not required to perform any obligations or incur any liability pursuant to this Agreement that have not been previously agreed to between ZEISS and the Third Party Licensor.

**2.6 Other Third Party Software.** In addition to the Software licensed under this Agreement, certain software provided by Third Party Licensors (including open source and off-the-shelf software) may be appropriate or necessary for use with the Software or the hardware on which the Software operate, and are licensed to You under separate terms and conditions, as specified in [Addendum A Additional Terms for Off-the-Shelf Software](#) or in the Documentation (such software, the “**Other Third Party Software**”). You may only use the Other Third Party Software with the applicable software package as set forth in the terms and conditions under which such software is licensed. To the extent that the terms and conditions of such license are inconsistent with or contrary to the terms and conditions of this Agreement (including the licenses granted under this Agreement and any limitations or restrictions on those licenses, disclaimers of warranties and indemnification obligations), then the terms and conditions of the applicable license for the Other Third Party Software will prevail and control, but solely with respect to the Other Third Party Software. You acknowledge that the any license agreement for Other Third Party Software is solely between You and the applicable Third Party Licensor and You will comply with the terms of any such license.

**Additional Terms for Oracle Programs.** In addition to the terms set forth in the body of this Agreement, certain additional terms apply to the use of software, hardware and services provided by Oracle America, Inc. (“**Oracle**”). Such additional terms are set forth in [Addendum B Additional Terms for Oracle Software, Hardware and Services](#).

### **3. AUDIT.**

ZEISS may (i) audit Your use of the Software and (ii) require You to provide reasonable assistance and access to information in the course of such audit and permit ZEISS to report the audit results to Third Party Licensors, or to assign ZEISS’ right to audit Your use of the Software to such Third Party Licensor. Where ZEISS assigns its right to audit to a Third Party Licensor, the Third Party Licensor will not be responsible for any of ZEISS’ or Your costs incurred in cooperating with the audit.

### **4. NO WARRANTIES**

ZEISS AND THE THIRD PARTY LICENSORS MAKE NO REPRESENTATIONS OR WARRANTIES, EITHER EXPRESS OR IMPLIED, OF ANY KIND WITH RESPECT TO THE SOFTWARE PROVIDED UNDER THIS AGREEMENT OR THE HARDWARE ON WHICH THE SOFTWARE OPERATES. SUCH SOFTWARE AND

HARDWARE ARE PROVIDED "AS IS" WITH NO WARRANTY. YOU AGREE THAT YOUR USE OF THE SOFTWARE AND HARDWARE IS AT YOUR SOLE RISK. TO THE FULLEST EXTENT PERMISSIBLE UNDER APPLICABLE LAW, ZEISS AND THE THIRD PARTY LICENSORS EXPRESSLY DISCLAIM ALL WARRANTIES OF ANY KIND, EXPRESS OR IMPLIED, WITH RESPECT TO THE SOFTWARE AND HARDWARE, INCLUDING WARRANTIES OF MERCHANTABILITY, FITNESS FOR A PARTICULAR PURPOSE, SATISFACTORY QUALITY, ACCURACY, TITLE AND NON-INFRINGEMENT, AND ANY WARRANTIES THAT MAY ARISE OUT OF COURSE OF PERFORMANCE, COURSE OF DEALING OR USAGE OF TRADE. ZEISS does not warrant that the Software or hardware will operate in combination with any software, hardware, systems or data not provided by ZEISS or with any operating system for which it was not designed, except as expressly specified in the Documentation, and ZEISS and the Third Party Licensors do not warrant that the operation of the Software or hardware will be uninterrupted or error-free.

#### 5. LIMITATION OF LIABILITY

In no event will ZEISS, or any of the Third Party Licensors, be liable for any direct, indirect, incidental, special, consequential or punitive damages, or damages for loss of profits, revenue, business, savings, data or data use, use or cost of substitute procurement, incurred by You or any third party, whether in an action in contract or tort, even if ZEISS has been advised of the possibility of such damages or if such damages are foreseeable. Without limiting the foregoing, if for any reason the foregoing limitation is not fully enforced, in no event will ZEISS' liability for damages hereunder exceed the amounts actually paid by You to ZEISS for HFA3. The parties acknowledge that the limitation of liability in this Section 5 and in the other provisions of this Agreement and the allocation of risk herein are an essential element of the bargain between the parties, without which ZEISS would not have entered into this Agreement. ZEISS' pricing reflects this allocation of risk and the limitation of liability specified herein.

#### 6. TERMINATION

This Agreement is effective until terminated. ZEISS may terminate this Agreement at any time upon Your breach of any of the provisions hereof. Upon termination of this Agreement, You will cease all use of the Software, return to ZEISS or destroy the Software and all Documentation and related materials in Your possession, and so certify to ZEISS. Except for the license granted herein and as expressly provided herein, the terms of this Agreement will survive termination.

#### 7. GENERAL TERMS

7.1 **Governing Law.** This Agreement will be interpreted under the substantive laws of the State of New York. The 1980 United Nations Convention on Contracts for the International Sale of Goods ("CISG") and any reference thereto and the Uniform Computer Information Transactions Act (UCITA) are explicitly excluded.

7.2 **Waiver of Jury Trial.** EACH PARTY HEREBY WAIVES ITS RIGHT TO A TRIAL BY JURY FOR DISPUTES ARISING OUT OF OR RELATED TO THIS AGREEMENT, INCLUDING WITHOUT LIMITATION COUNTERCLAIMS REGARDING SUCH DISPUTES, CLAIMS RELATED TO THE PARTIES' NEGOTIATIONS AND INDUCEMENTS TO ENTER INTO THIS AGREEMENT, AND OTHER CHALLENGES TO THE VALIDITY OR ENFORCEABILITY OF THIS AGREEMENT. THE WAIVER IN THE PRECEDING SENTENCE APPLIES REGARDLESS OF THE TYPE OF DISPUTE, WHETHER PROCEEDING UNDER CLAIMS OF CONTRACT OR TORT (INCLUDING WITHOUT LIMITATION NEGLIGENCE) OR ANY OTHER THEORY.

7.3 **Severability.** If for any reason a court of competent jurisdiction finds any provision of this Agreement invalid or unenforceable, that provision of the Agreement will be enforced to the maximum extent permissible and the other provisions of this Agreement will remain in full force and effect.

7.4 **Waiver.** If either party fails to exercise a right or insist on strict performance under this Agreement on one (1) occasion, that party will not be precluded from exercising that right, or insisting on performance of that obligation on any other occasion; nor will this Agreement be modified in any way by such failure to exercise a right or insist on strict performance under this Agreement.

7.5 **No Assignment.** You will not assign or transfer any rights, duties or obligations under this Agreement, in full or in part, by operation of law or otherwise, without ZEISS' prior written consent. ZEISS may freely assign this Agreement.

7.6 **Third Party Beneficiaries.** You hereby acknowledge that the Third Party Licensors are intended third party beneficiaries of this Agreement and have the right to bring legal action in their own name against You with respect to the Software.

7.7 **Export Administration.** You will comply fully with all relevant export laws and regulations of the United States and other applicable export and import laws, including, without limitation, the U.S. Export Administration Regulations (collectively "Export Controls"). Without limiting the generality of the foregoing, You will not, and You will require Your representatives not to, export, direct or transfer the Software, or any direct product thereof, to any destination, person or entity restricted or prohibited by the Export Controls.

7.8 **Use Restriction.** The Software, including any integrated Third Party Software, are not specifically designed, manufactured or intended for use as parts, components or assemblies for the planning, construction, maintenance or operation of a nuclear facility. You may not use the Software for these purposes.

7.9 **Entire Agreement.** This Agreement, including any addenda, constitutes the entire agreement between the parties and, other than any ZEISS standard form customer agreement signed by the parties, supersedes all prior or contemporaneous agreements or representations, written or oral, concerning the subject matter of this Agreement. In the event of a conflict between the terms of this Agreement and a signed ZEISS standard form customer Agreement, this Agreement will control, but solely with respect to the Software. This Agreement may not be modified or amended except in a writing signed by a duly authorized representative of each party; no other act, document, usage or custom will be deemed to amend or modify this Agreement. It is expressly agreed that the terms of this Agreement will supersede the terms in any of Your purchase orders or other ordering documents.

7.10 **Notice to United States Government End Users.** The Software and Documentation delivered to U.S. Government end users are "commercial computer software" as defined in the Federal Acquisition Regulation (FAR). As such, use, duplication, disclosure, modification and adaptation of the Software and Documentation will be subject to the license and license restrictions set forth in this Agreement.

7.11 **Additional Information.** For Your future reference a copy of this End User License Agreement will be accessible after You configure the Software. If You have any questions

regarding this Agreement or if You wish to request any information from ZEISS, please use the address information enclosed with HFA3 to contact the local ZEISS office serving Your country, or write to Customer Service, Carl Zeiss Meditec, Inc., 5160 Hacienda Drive, Dublin, CA 94568.

### Addendum A Additional Terms for Off-the-Shelf Software

Certain off-the-shelf (OTS) software packages are included in the Software and are licensed to You under the terms set forth below.

#### 1. MIT License

**a. The following OTS software components are licensed under the MIT license.**

- AngularJS JavaScript Library (Used by DevExpress)
- AutoFac
- Globalize JavaScript Library (Used by DevExpress)
- jQuery JavaScript Library (Used by DevExpress)
- Knockout JavaScript Library (Used by DevExpress)
- Some components of Microsoft .NET Framework 4.5.2
- Newtonsoft.Json

**b. Text of the MIT License:**

Copyright (c) 2007 James Newton-King

Permission is hereby granted, free of charge, to any person obtaining a copy of this software and associated documentation files (the "OTS Software"), to deal in the OTS Software without restriction, including without limitation the rights to use, copy, modify, merge, publish, distribute, sublicense, and/or sell copies of the OTS Software, and to permit persons to whom the OTS Software is furnished to do so, subject to the following conditions:

The above copyright notice and this permission notice shall be included in all copies or substantial portions of the OTS Software.

THE OTS SOFTWARE IS PROVIDED "AS IS", WITHOUT WARRANTY OF ANY KIND, EXPRESS OR IMPLIED, INCLUDING BUT NOT LIMITED TO THE WARRANTIES OF MERCHANTABILITY, FITNESS FOR A PARTICULAR PURPOSE AND NONINFRINGEMENT. IN NO EVENT SHALL THE AUTHORS OR COPYRIGHT HOLDERS BE LIABLE FOR ANY CLAIM, DAMAGES OR OTHER LIABILITY, WHETHER IN AN ACTION OF CONTRACT, TORT OR OTHERWISE, ARISING FROM, OUT OF OR IN CONNECTION WITH THE OTS SOFTWARE OR THE USE OR OTHER DEALINGS IN THE OTS SOFTWARE.

#### 2. BSD License

**a. The following OTS software components are licensed under the BSD license:**

- Some components of Microsoft .NET Framework 4.5.2

**b. Text of the BSD License:**

Copyright (c) <year>, <copyright holder>

All rights reserved.

Redistribution and use in source and binary forms, with or without modification, are permitted provided that the following conditions are met:

1. Redistributions of source code must retain the above copyright notice, this list of conditions and the following disclaimer.

2. Redistributions in binary form must reproduce the above copyright notice, this list of conditions and the following disclaimer in the documentation and/or other materials provided with the distribution.

3. All advertising materials mentioning features or use of this software must display the following acknowledgment: This product includes software developed by the <organization>.

4. Neither the name of the <organization> nor the names of its contributors may be used to endorse or promote products derived from this software without specific prior written permission.

THIS SOFTWARE IS PROVIDED BY <COPYRIGHT HOLDER> "AS IS" AND ANY EXPRESS OR IMPLIED WARRANTIES, INCLUDING, BUT NOT LIMITED TO, THE IMPLIED WARRANTIES OF MERCHANTABILITY AND FITNESS FOR A PARTICULAR PURPOSE ARE DISCLAIMED. IN NO EVENT SHALL <COPYRIGHT HOLDER> BE LIABLE FOR ANY DIRECT, INDIRECT, INCIDENTAL, SPECIAL, EXEMPLARY, OR CONSEQUENTIAL DAMAGES (INCLUDING, BUT NOT LIMITED TO, PROCUREMENT OF SUBSTITUTE GOODS OR SERVICES; LOSS OF USE, DATA, OR PROFITS; OR BUSINESS INTERRUPTION) HOWEVER CAUSED AND ON ANY THEORY OF LIABILITY, WHETHER IN CONTRACT, STRICT LIABILITY, OR TORT (INCLUDING NEGLIGENCE OR OTHERWISE) ARISING IN ANY WAY OUT OF THE USE OF THIS SOFTWARE, EVEN IF ADVISED OF THE POSSIBILITY OF SUCH DAMAGE.

**3. OpenCV License****a. The OpenCV software is licensed under the OpenCV license below:**

*By downloading, copying, installing or using the software you agree to this license. If you do not agree to this license, do not download, install, copy or use the software.*

License Agreement

For Open Source Computer Vision Library

(3-clause BSD License)

Redistribution and use in source and binary forms, with or without modification, are permitted provided that the following conditions are met:

- Redistributions of source code must retain the above copyright notice, this list of conditions and the following disclaimer.
- Redistributions in binary form must reproduce the above copyright notice, this list of conditions and the following disclaimer in the documentation and/or other materials provided with the distribution.
- Neither the names of the copyright holders nor the names of the contributors may be used to endorse or promote products derived from this software without specific prior written permission.

This software is provided by the copyright holders and contributors "as is" and any express or implied warranties, including, but not limited to, the implied warranties of merchantability and fitness for a particular purpose are disclaimed. In no event shall copyright holders or contributors be liable for any direct, indirect, incidental, special, exemplary, or consequential damages (including, but not limited to, procurement of substitute goods or services; loss of use, data, or profits; or business interruption) however caused and on any theory of liability, whether in contract, strict liability, or tort (including negligence or otherwise) arising in any way out of the use of this software, even if advised of the possibility of such damage.

#### 4. LGPL2

- a. **The following OTS software is licensed under the LGPL2 (GNU Lesser General Public License) license:**
  - AForge .NET Framework
  - NHibernate

- b. **Text of the LGPL2 (GNU Lesser General Public License) License:**

GNU LESSER GENERAL PUBLIC LICENSE  
Version 3, 29 June 2007

Copyright (C) 2007 Free Software Foundation, Inc. <<http://fsf.org/>>  
Everyone is permitted to copy and distribute verbatim copies of this license document, but changing it is not allowed.

This version of the GNU Lesser General Public License incorporates the terms and conditions of version 3 of the GNU General Public License, supplemented by the additional permissions listed below.

#### 0. Additional Definitions.

As used herein, "this License" refers to version 3 of the GNU Lesser General Public License, and the "GNU GPL" refers to version 3 of the GNU General Public License.

"The Library" refers to a covered work governed by this License, other than an Application or a Combined Work as defined below.

An "Application" is any work that makes use of an interface provided by the Library, but which is not otherwise based on the Library. Defining a subclass of a class defined by the Library is deemed a mode of using an interface provided by the Library.

A "Combined Work" is a work produced by combining or linking an Application with the Library. The particular version of the Library with which the Combined Work was made is also called the "Linked Version".

The "Minimal Corresponding Source" for a Combined Work means the Corresponding Source for the Combined Work, excluding any source code for portions of the Combined Work that, considered in isolation, are based on the Application, and not on the Linked Version.

The "Corresponding Application Code" for a Combined Work means the object code and/or source code for the Application, including any data and utility programs needed for reproducing the Combined Work from the Application, but excluding the System Libraries of the Combined Work.

#### 1. Exception to Section 3 of the GNU GPL.

You may convey a covered work under sections 3 and 4 of this License without being bound by section 3 of the GNU GPL.

#### 2. Conveying Modified Versions.

If you modify a copy of the Library, and, in your modifications, a facility refers to a function or data to be supplied by an Application that uses the facility (other than as an argument passed when the facility is invoked), then you may convey a copy of the modified version:

- a) under this License, provided that you make a good faith effort to ensure that, in the event an Application does not supply the function or data, the facility still operates, and performs whatever part of its purpose remains meaningful, or
- b) under the GNU GPL, with none of the additional permissions of this License applicable to that copy.

#### 3. Object Code Incorporating Material from Library Header Files.

The object code form of an Application may incorporate material from a header file that is part of the Library. You may convey such object code under terms of your choice, provided that, if the incorporated material is not limited to numerical parameters, data structure layouts and accessors, or small macros, in-line functions and templates (ten or fewer lines in length), you do both of the following:

- a) Give prominent notice with each copy of the object code that the Library is used in it and that the Library and its use are covered by this License.

b) Accompany the object code with a copy of the GNU GPL and this license document.

#### 4. Combined Works.

You may convey a Combined Work under terms of your choice that, taken together, effectively do not restrict modification of the portions of the Library contained in the Combined Work and reverse engineering for debugging such modifications, if you also do each of the following:

a) Give prominent notice with each copy of the Combined Work that the Library is used in it and that the Library and its use are covered by this License.

b) Accompany the Combined Work with a copy of the GNU GPL and this license document.

c) For a Combined Work that displays copyright notices during execution, include the copyright notice for the Library among these notices, as well as a reference directing the user to the copies of the GNU GPL and this license document.

d) Do one of the following:

0) Convey the Minimal Corresponding Source under the terms of this License, and the Corresponding Application Code in a form suitable for, and under terms that permit, the user to recombine or relink the Application with a modified version of the Linked Version to produce a modified Combined Work, in the manner specified by section 6 of the GNU GPL for conveying Corresponding Source.

1) Use a suitable shared library mechanism for linking with the Library. A suitable mechanism is one that (a) uses at run time a copy of the Library already present on the user's computer system, and (b) will operate properly with a modified version of the Library that is interface-compatible with the Linked Version.

e) Provide Installation Information, but only if you would otherwise be required to provide such information under section 6 of the GNU GPL, and only to the extent that such information is necessary to install and execute a modified version of the Combined Work produced by recombining or relinking the Application with a modified version of the Linked Version. (If you use option 4d0, the Installation Information must accompany the Minimal Corresponding Source and Corresponding Application Code. If you use option 4d1, you must provide the Installation Information in the manner specified by section 6 of the GNU GPL for conveying Corresponding Source.)

#### 5. Combined Libraries.

You may place library facilities that are a work based on the Library side by side in a single library together with other library facilities that are not Applications and are not covered by this License, and convey such a combined library under terms of your choice, if you do both of the following:



a) Accompany the combined library with a copy of the same work based on the Library, uncombined with any other library facilities, conveyed under the terms of this License.

b) Give prominent notice with the combined library that part of it is a work based on the Library, and explaining where to find the accompanying uncombined form of the same work.

#### 6. Revised Versions of the GNU Lesser General Public License.

The Free Software Foundation may publish revised and/or new versions of the GNU Lesser General Public License from time to time. Such new versions will be similar in spirit to the present version, but may differ in detail to address new problems or concerns.

Each version is given a distinguishing version number. If the Library as you received it specifies that a certain numbered version of the GNU Lesser General Public License "or any later version" applies to it, you have the option of following the terms and conditions either of that published version or of any later version published by the Free Software Foundation. If the Library as you received it does not specify a version number of the GNU Lesser General Public License, you may choose any version of the GNU Lesser General Public License ever published by the Free Software Foundation.

If the Library as you received it specifies that a proxy can decide whether future versions of the GNU Lesser General Public License shall apply, that proxy's public statement of acceptance of any version is permanent authorization for you to choose that version for the Library.

### Addendum B

#### Additional Terms for Oracle Software, Hardware and Services

Where the Software includes software, including any operating system, provided by Oracle (the “Oracle Programs”), or where any hardware or services are provided by Oracle, the following terms will apply in addition to the terms contained in the body of the Agreement:

1. Your use of the Oracle Programs delivered with any hardware is restricted to the terms of the Agreement, and such Oracle Programs may only be used as incorporated in, and as part, of such hardware.
2. Ancillary programs are those third party materials specified in the applicable Documentation which may only be used for the purposes of installing or operating the programs with which the ancillary programs are delivered.
3. If You decide to finance Your acquisition of the Oracle Programs, or any hardware or services provided by Oracle, You will follow Oracle’s policies regarding financing, which are available at <http://oracle.com/contracts>.
4. Any additional programs that Oracle may include with the Oracle Programs or the hardware provided by Oracle may be used for trial, non-production purposes only. You may not use such additional programs to provide training or attend training provided by ZEISS or a third party on the content and/or functionality of the programs. You will have thirty (30) days from the delivery date of the additional programs to evaluate such programs, subject to the terms of the Agreement. If You decide to use the additional programs after the thirty (30) day trial period, You must obtain a license for such programs from ZEISS. If You decide not to obtain a license for the additional programs after the thirty (30) day trial period, You will cease using and will delete any such programs from Your computer systems. Additional programs included with any order are provided “as is” and Oracle does not provide technical support or offer any warranties for these programs.
5. Any third party firms retained by You to provide computer consulting services are independent of Oracle and are not Oracle’s agents. Oracle is not liable for nor bound by any acts of such third party firm.
6. Hardware, if purchased from Oracle, includes Oracle’s hardware warranty in effect at the time the hardware is purchased. Oracle’s hardware warranty can be accessed at <http://www.oracle.com/support/policies.html>.
7. You have not relied on the future availability of any Oracle Programs, hardware or updates in entering into the Agreement. However, (a) if You order technical support from Oracle, the preceding sentence will not relieve Oracle of its obligation to provide updates under such order, if-and-when available, in accordance with Oracle’s then-current technical support policies and (b) the preceding sentence will not change the rights granted under the Agreement for any Oracle Program licensed under the Agreement, per the terms of the Agreement.

#### Acknowledgment

You acknowledge that you have read all the provisions in this Chapter, including this License and Limited Warranty, understand them, and agree to be bound by their terms and conditions.



FORUM, FORUM Glaucoma Workplace  0297

 **Carl Zeiss Meditec AG**

Goeschwitzer Strasse 51-52  
07745 Jena  
Germany  
Phone: +49 36 41 22 03 33  
Fax: +49 36 41 22 01 12  
[info.meditec@zeiss.com](mailto:info.meditec@zeiss.com)  
[www.zeiss.com/med](http://www.zeiss.com/med)



Humphrey Field Analyzer 3 (HFA3)  0297

 **Carl Zeiss Meditec, Inc.**

5160 Hacienda Drive  
Dublin, CA 94568  
USA  
Toll Free: 1 800 341 6968  
Phone: +1 925 557 4100  
Fax: +1 925 557 4101  
[info.meditec.us@zeiss.com](mailto:info.meditec.us@zeiss.com)  
[www.zeiss.com/med](http://www.zeiss.com/med)

 **Carl Zeiss Meditec AG**

Goeschwitzer Strasse 51-52  
07745 Jena  
Germany  
Phone: +49 36 41 22 03 33  
Fax: +49 36 41 22 01 12  
[info.meditec@zeiss.com](mailto:info.meditec@zeiss.com)  
[www.zeiss.com/med](http://www.zeiss.com/med)

2660021166131 Rev. A 2018-11  
HFA3 Models 830, 840, 850, 860 Instructions for Use  
Specifications subject to change without notice