

CARESCAPE Monitors B850 and B650

User's Manual

Software version 2

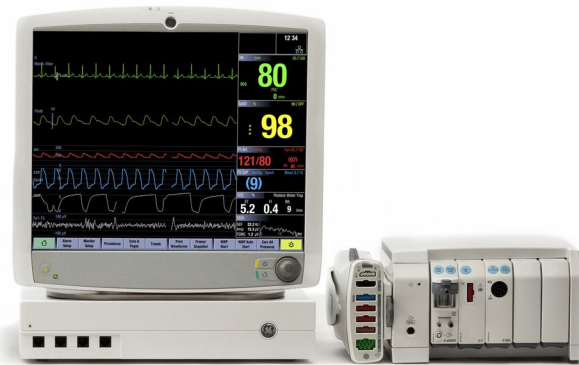

The information in this manual applies to the software version listed on the first page of the manual. Due to continuing product innovation, specifications in this manual are subject to change without notice.

For technical documentation purposes, the abbreviation GE is used for the legal entity names, GE Medical Systems *Information Technologies*, Inc. and GE Healthcare Finland Oy.

Contents

1	About this manual	39
	Intended use of this manual.....	39
	Intended markets of this manual.....	39
	Intended audience of this manual.....	39
	Training requirements	39
	Manual conventions	39
	Monitor naming conventions	40
	Acquisition module naming conventions	40
	Illustrations and names	41
	Related documents.....	41
	Ordering manuals	41
	Trademarks	41
	Third party trademarks.....	41
	Manufacturer responsibility	42
2	Safety	43
	Safety message signal words.....	43
	System safety	43
	System warning safety messages	43
	Accessories warnings	43
	Cables warnings.....	44
	Defibrillation warnings.....	44
	Electrical warnings.....	44
	Equipment warnings.....	45
	Site requirement warnings	46
	System caution safety messages	46
	Loss of data	46
	Electrical caution.....	46
	Site requirement cautions	47
	Notice safety messages	47
	Safety symbols	47
	Indications for use.....	48

B850 indications for use	48
B650 indications for use	49
Indications for use safety precautions	49
Indications for use warnings	49
Indications for use cautions	50
Training requirements	50
Electromagnetic compatibility	50
EMC warnings.....	50
EMC cautions.....	50
ESD safety precautions.....	51
3 System introduction	53
Monitor and module compatibility limitations	53
System safety precautions.....	53
System warnings.....	53
System caution.....	54
B850 system components.....	55
B850 processing unit front view.....	56
B850 processing unit back view.....	56
B850 module frames F7 and F5	57
B850 Tram-Rac frames 2A and 4A.....	58
B650 system components.....	58
B650 monitor front panel	59
B650 monitor side views.....	60
B650 monitor back panel	60
B650 pivoting module frame.....	61
Monitor battery	62
Inserting and removing the B650 monitor battery	63
Checking the battery charge with monitor software.....	63
Monitor battery charge symbols on screen.....	64
Battery test button	64
Alarm light	65
Displays.....	65
Acquisition modules.....	66
PSMP front view.....	66

PDM front view	67
TRAM module front view	68
Single-parameter Tram-Rac front view	68
Modules and parameters	69
Barcode reader	73
Keyboard	73
Mouse	73
Remote control and keypad	74
Recorders and laser printers	74
About the Unity Network Interface Device (ID).....	74
CIC Pro Clinical Information Center.....	75
iCentral	75
Remote alarm box (nurse call).....	76
iPanel software application	76
Equipment symbols	77
User interface symbols.....	84
4 Monitoring basics	89
Module compatibility limitations.....	89
Identical modules.....	89
Connecting and removing modules: B850.....	90
Connecting a PDM or PSM to a frame.....	90
Removing a PDM or PSM from a frame	90
Connecting other E-modules than the PSM to a frame.....	90
Removing other E-modules than PSM from a frame	91
Connecting TRAM modules to a Tram-Rac housing	91
Removing TRAM modules from a Tram-Rac housing	91
Connecting and removing modules: B650.....	92
Connecting a PDM or PSM to the B650.....	92
Removing a PSM or PDM from the B650.....	92
Connecting other E-modules than PSM to the B650	92
Removing other E-modules than PSM from the B650	93
Main keys.....	93
Main screen layout.....	95
An example of a menu.....	96

Menu options.....	97
Selecting menu options with a touchscreen	97
Selecting menu options with the Trim Knob control.....	98
Selecting menu options with a mouse.....	98
Data field entries.....	98
Entering data with the on-screen keyboard.....	98
Entering data with a keyboard.....	98
Putting the monitor into operation	98
Operation warnings	98
Operation caution	99
Monitor installation points to note.....	99
Turning on the monitor.....	99
Performance check.....	100
Message about PDM service	100
Pre-monitoring checklist.....	100
Supply mains interruption	100
Power failure alarm.....	100
5 Setting up the monitor before use.....	103
Normal screen and other pages	103
Selecting the normal screen (main page)	103
Selecting pages	103
Adjusting sound volumes	104
Brightness settings	104
B850 display brightness.....	104
Adjusting the display brightness automatically	104
Adjusting the display brightness manually.....	104
Adjusting the alarm light brightness.....	105
Setting the keyboard light to turn on automatically	105
Turning the keyboard light on manually.....	105
Screen setup modifications.....	105
Parameter windows.....	105
Selecting parameters to the screen.....	106
Waveform field safety precautions.....	106
Selecting the display mode for IP waveforms	107

Setting up a split screen.....	107
Locked alarm and parameter settings	107
Color selections	108
Parameter configurations.....	108
Setting up printing options	108
Checking the PDM battery status	108
Checking the monitor battery status.....	109
Setting the touchscreen off.....	109
B850 with several screens.....	109
Other setup changes	109
6 Starting and ending monitoring	111
Monitor and module compatibility.....	111
Software packages and terminology.....	111
About the user default settings.....	111
Invasive pressure labels and PDM or TRAM.....	111
Starting monitoring.....	112
About the combination monitoring mode.....	113
Entering patient data.....	114
Entering patient data with the monitor	114
Entering patient data with a barcode reader.....	115
About the roving functionality.....	115
Roving between units.....	116
Roving between beds.....	116
Adding new units and beds (manual roving).....	116
Entering administrative information.....	117
Loading patient information from the CARESCAPE Network (ADT server).....	117
Loading patient data and trend data from the S/5 Network.....	117
About standby	118
Starting standby.....	118
End of standby.....	119
About continuing monitoring	119
How to continue monitoring when a case is not active/patient is discharged.....	119

How to continue monitoring when a case is active/patient is admitted	120
About case reset/patient discharge	121
Pending software or setting activation.....	121
Residual physiological data.....	121
Resetting a case/discharging a patient.....	121
Resetting a case/discharging a patient in combination monitoring mode.....	122
7 Alarms	123
Alarm warnings.....	123
Alarm cautions.....	125
Alarm overview	125
Alarm types.....	125
Alarm conditions	125
Alarm priority levels.....	126
Alarm priority escalation.....	126
Physiological alarms' activation criteria	126
Broadcast only alarms.....	127
Checking alarm function.....	129
Alarm indications	129
Alarm icons on the screen	129
Description of alarm and information messages.....	130
Setting the alarm light brightness.....	130
Audible alarm signals.....	131
Audible and visual alarm signals.....	131
Auditory information signals	132
Audible alarms off behavior	132
Pause audio behaviors	133
Pausing alarms for 5 minutes.....	134
Activating all audible alarms	134
Technical alarms' deactivation with the pause audio key	134
Apnea alarms' deactivation with the pause audio key.....	135
Pause audio with combination monitoring	135
Breakthrough alarms.....	135

Latched alarms	135
Setting parameter alarm limits	136
Alarm locks	136
Alarm guard limits	136
Setting arrhythmia alarms	136
Selecting parameter alarm priority levels	137
Setting alarm limits automatically	138
Default auto alarm limits	138
Returning the default alarm limits	139
Turning off all local alarm indicators (sleep mode)	139
Remote management of alarms	139
Alarm settings after a power loss	140
Alarm data stored in Clinical logs	140
Stored alarm data during a power cycle or power loss	140
8 ECG	141
ECG compatibility limitations	141
ECG safety precautions	141
ECG warnings	141
ECG cautions	143
ECG measurement limitations	143
ECG points to note	143
ECG measurement setup	144
ECG equipment to patient connection	144
Preparing the patient's electrode sites	144
Applying the electrodes to the patient	144
3-lead or 5-lead ECG electrode placement	145
6-lead ECG electrode placement	145
10-lead ECG electrode placement for cardiac monitoring	146
Standard resting 10-lead ECG electrode placement	147
Checking the ECG measurement	148
About the ECG analog output signal	148
About the combination monitoring mode	149
Selecting the ECG source	150
Using the ECG measurement	150

The first three displayed ECG leads.....	150
Selecting the Va ECG lead.....	151
Combination monitoring and Va/Vb lead selections with 6-lead cable.....	151
Selecting the Vb ECG lead.....	152
Changing to an ECG cable with fewer leadwires	152
Deactivating the ECG leads off alarm	152
Selecting the beat source	152
Setting the beat volume.....	153
Setting the beep tone during bradycardia and HR low alarms.....	153
Variable beat tone.....	153
Aspect ratio and different display sizes	153
Selecting the ECG waveform size	154
Selecting the hemodynamic waveform sweep speed.....	154
Printing all ECG waveforms	154
Selecting the ECG waveform filter.....	154
Setting the QRS width	155
Selecting the leads for ECG analysis	155
Relearning the patient's QRS pattern.....	156
Setting the primary HR source	156
Showing a second HR value in the HR parameter window.....	156
Showing ST in the HR parameter window	157
Showing PVC in the HR parameter window	157
Showing QT in the HR parameter window.....	157
Displaying the ECG grid.....	157
ECG alarm limits	157
Selecting the HR alarm range	159
ECG alarm priorities	159
ECG measurement practicalities.....	159
Alternate pulse rate source	159
PDM IntelliRate algorithm	159
TRAM, E-modules, and telemetry transmitters Auto algorithm.....	159
ECG troubleshooting	160
12 lead analysis.....	160

Intended use of 12RL Interpolated 12 lead ECG analysis	160
Intended use of 12SL ECG analysis	161
Intended use of ACI-TIPI.....	161
12 lead ECG analysis points to note.....	161
Entering data for a 12 lead ECG analysis	161
Entering data for an ACI-TIPI 12 lead ECG analysis	162
Enabling and disabling the 12SL ACS.....	162
Entering the Location ID for 12SL.....	163
Setting automatic 12 lead ECG analysis measurements.....	163
Setting the 12 lead ECG analysis display format.....	163
Generating a 12 lead ECG analysis report during an ST alarm condition	163
Performing a 12 lead ECG analysis	164
A 12 lead report and the MUSE database	164
Sending a 12 lead ECG report to the MUSE database	164
Viewing or printing saved 12 lead ECG reports.....	164
About the 12 lead ECG analysis program.....	165
About the 12RL ECG analysis program	166
12 lead ECG analysis troubleshooting	166
Pacemaker detection.....	166
Pacemaker detection warnings	166
Pacemaker detection points to note.....	167
Selecting the pacemaker detection	167
Pacemaker detection troubleshooting	168
Arrhythmia monitoring	169
Arrhythmia monitoring warnings.....	169
Arrhythmia measurement limitations.....	170
Setting the arrhythmia category to alarm.....	171
Combination monitoring and arrhythmia alarm categories.....	171
Setting arrhythmia alarms.....	171
Setting the alarm pause interval.....	172
Setting the SVT length.....	172
Setting HR for SVT	172
Arrhythmia alarm messages	172

About the arrhythmia detection.....	175
Arrhythmia troubleshooting	175
ST detection.....	177
About the ST analysis.....	177
ST detection measurement limitations.....	177
ST detection points to note.....	177
Starting the ST detection	177
Selecting leads to the ST window.....	178
Changing the displayed ST leads	178
Adjusting the ST point manually.....	178
Adjusting the isoelectric measurement (ISO) point.....	178
Adjusting the J point	179
About the realtime QRS/ST complexes	179
About the reference QRS	179
Saving a reference QRS manually	179
Automatic saving of reference QRS complexes	179
Selecting a saved reference QRS complex for display.....	180
Erasing a reference QRS	180
Printing a realtime QRS/ST report	180
Viewing QRS and ST in a split screen	180
Selecting the ST time scale	181
ST trend display	181
Displaying QRS complexes and ST trends for other leads.....	181
Reviewing ST trends.....	181
Printing an ST trend report	181
Ischemic burden.....	182
ST alarm limits	183
QT detection	183
9 Impedance respiration.....	185
Impedance respiration compatibility limitations	185
Respiration safety precautions	185
Respiration warnings	185
Respiration cautions	186
Respiration measurement limitations.....	186

Respiration points to note	186
Respiration measurement setup.....	187
Respiration equipment to patient connection.....	187
Preparing the patient's respiration electrode sites	187
Respiration lead and breath detection	187
Respiration lead I electrode placement.....	188
Respiration lead II electrode placement.....	189
Respiration lead RL-LL electrode placement.....	189
Respiration measurement checks.....	190
Respiration measurement on the monitor screen.....	190
Using the respiration measurement.....	190
Turning on the respiration measurement.....	190
Selecting the respiration lead.....	190
Selecting the respiration waveform size manually	190
Selecting the respiration waveform size automatically.....	190
Selecting the waveform speed.....	191
Selecting the waveform sensitivity	191
Relearning the respiration pattern.....	191
Turning on or off the respiration rate alarm.....	191
Setting the respiration alarm limits.....	191
Setting the apnea alarm delay.....	192
Apnea alarms' deactivation with the pause audio key.....	192
Enabling the respiration cardiac artifact alarm	192
Respiration alarm priorities	192
Turning off the respiration measurement	192
Respiration measurement description	193
Respiration measurement with PSM.....	193
Respiration measurement with PDM and TRAM	193
How to interpret the respiration values.....	193
Respiration troubleshooting.....	193
10 Pulse oximetry.....	195
SpO ₂ compatibility limitations.....	195
SpO ₂ safety precautions.....	195
SpO ₂ warnings.....	195

SpO ₂ cautions	198
SpO ₂ measurement limitations	198
SpO ₂ points to note	198
SpO ₂ measurement guidelines.....	199
GE Ohmeda technology and sensor measurement guidelines.....	199
Masimo SET technology and sensor measurement guidelines.....	199
Nellcor OxiMax technology and sensor measurement guidelines.....	200
SpO ₂ measurement setup	201
SpO ₂ equipment to patient connection	201
Preparing the SpO ₂ connection.....	201
Checking the SpO ₂ measurement.....	201
Using the SpO ₂ measurement.....	202
Primary and secondary SpO ₂ measurement sources.....	202
Changing the SpO ₂ waveform size.....	202
Changing the SpO ₂ waveform scale	203
Selecting the SpO ₂ hemodynamic sweep speed.....	203
Selecting the SpO ₂ as the primary heart rate source	203
Showing the SpO ₂ pulse rate.....	203
Adjusting the SpO ₂ pulse beep tone volume	203
Variable beat tone.....	204
Masimo SET data averaging and updating	204
Selecting the SpO ₂ averaging time	204
Selecting the Masimo SpO ₂ sensor sensitivity level	204
Nellcor OxiMax data averaging and updating	205
Selecting the SpO ₂ response time	205
Nellcor OxiMax Saturation Seconds alarm management.....	205
Setting the SpO ₂ alarms and alarm limits.....	207
Deactivating the SpO ₂ probe off alarm	207
SpO ₂ alarm priorities	207
Stopping the SpO ₂ measurement	207
How to interpret the SpO ₂ values.....	208
SpO ₂ signal strength	208
SpO ₂ waveform quality	208

SpO ₂ waveform stability	208
SpO ₂ wavelengths and optical output power	209
SpO ₂ measurement and interference.....	209
SpO ₂ troubleshooting.....	210
11 Non-invasive blood pressure.....	213
NIBP compatibility limitations	213
NIBP safety precautions	213
NIBP warnings	213
NIBP cautions	214
NIBP measurement limitations	215
NIBP points to note	215
NIBP measurement setup.....	216
NIBP equipment to patient connection.....	216
NIBP module keys.....	216
Preparing the NIBP patient connection	216
Checking the NIBP measurement	216
NIBP measurement on screen	217
Manual NIBP measurements.....	217
Starting or stopping a single NIBP measurement from the main menu.....	217
Starting or stopping a single NIBP measurement from the NIBP Setup menu.....	217
Starting or stopping a single NIBP measurement with the PSM module key	217
Automatic NIBP measurements.....	218
Automatic NIBP measurements and monitor clock synchronization.....	218
Setting the cycle time between NIBP measurements.....	218
NIBP Auto mode	218
STAT mode	219
Venous stasis.....	219
NIBP cuffs	220
NIBP cuff selection and placement.....	220
Selecting NIBP cuff size.....	220
Initial NIBP cuff inflation pressure	221

Selecting the cuff inflation limits	221
NIBP volume and display settings.....	221
Adjusting the NIBP measurement completion tone volume	221
Setting the NIBP display format	222
NIBP alarms.....	222
Setting NIBP alarms	222
Silenced NIBP alarms	222
NIBP recheck after alarm violation	222
NIBP measurement description	222
NIBP measurement technologies.....	223
TRAM modules' NIBP technology	224
PDM modules' NIBP technology	225
PSM modules' NIBP technology.....	225
NIBP calibration.....	226
NIBP troubleshooting.....	227
12 Invasive pressures	229
Invasive pressures compatibility limitations	229
Invasive pressure safety precautions	229
Invasive pressure warnings	229
Invasive pressure measurement limitations	229
Invasive pressure points to note	230
Invasive pressure measurement setup	230
Invasive pressure equipment to patient connection	230
Invasive pressure module keys	231
Connecting the invasive pressure transducer and cable	231
Checking the invasive pressure measurement	231
Invasive pressure measurement on the monitor screen.....	231
Selecting the display mode for IP waveforms	232
Using the invasive pressure measurement.....	232
Invasive pressure measurement mapping.....	232
Invasive pressure analog output.....	233
About zeroing the invasive pressure transducers.....	233
Zeroing the invasive pressure transducers	234
Selecting an invasive pressure channel label.....	234

Selecting the size of the invasive pressure waveform	234
Optimizing the invasive pressure waveform scale.....	234
Selecting the hemodynamic waveform sweep speed.....	235
Selecting the invasive pressure noise reduction filter.....	235
Selecting the displayed invasive pressure format.....	235
Selecting invasive pressure as the primary heart rate source.....	235
Variable beat tone.....	236
Selecting the ventilation mode.....	236
Showing the pulse rate in the invasive pressure parameter window	236
Showing the CPP value in the ICP parameter window.....	236
Selecting Smart BP.....	237
Compensating for intra-aortic balloon pump (IABP) waveform irregularities.....	237
Selecting the invasive pressure response time	237
Using the IP channel standby.....	237
Using the invasive pressure waveform cursor	238
Setting an arterial invasive pressure disconnection alarm	238
Setting invasive pressure alarm limits	238
Invasive pressures alarm priorities	239
Systolic pressure variation and pulse pressure variation.....	239
Changing the SPV source	239
Measuring SPV manually.....	239
PA catheter insertion	240
Selecting the PA catheter insertion mode	240
Pulmonary capillary wedge pressure (PCWP) measurement.....	240
Showing the PCWP value in the PA window.....	241
Taking a manual PA wedge measurement.....	241
Taking an automated PA wedge measurement.....	241
Starting a new PA wedge measurement	242
Other selections in the Wedge menu.....	242
Calibrating the invasive pressure measurement with PDM and TRAM.....	242
Invasive pressure calibration with E-modules	243
Invasive pressure practicalities	243

Invasive pressure parameters.....	243
Intra-aortic balloon pump	243
Invasive pressure troubleshooting.....	246
13 Temperature.....	249
Temperature compatibility limitations.....	249
Temperature safety precautions.....	249
Temperature warnings	249
Temperature measurement limitations.....	249
Temperature points to note.....	249
Temperature measurement setup.....	250
Temperature equipment to patient connection.....	250
Preparing the patient for temperature measurement.....	250
Checking the temperature measurement	251
Temperature measurement on the monitor screen	251
Using the temperature measurement.....	251
Temperature mappings	251
Starting the temperature measurement	252
Changing the temperature site label	252
Displaying the delta value between two temperature channels	252
Setting temperature alarms	252
Stopping the temperature measurement.....	253
Temperature practicalities	253
Temperature troubleshooting	253
14 Cardiac output	255
C.O. safety precautions.....	255
C.O. warnings.....	255
C.O./CCO cautions	255
C.O. measurement limitations	255
C.O. points to note.....	255
C.O. measurement setup	256
C.O. equipment to patient connection with an in-line probe.....	256
C.O. equipment to patient connection with a bath probe	257
C.O. module key	257
Preparing the C.O. measurement.....	257

Checking the C.O. measurement.....	258
Using the C.O. measurement.....	258
Entering patient data for the C.I. value	258
C.O. measurement modes	258
C.O. trial measurements.....	260
Editing the C.O. average.....	260
Canceling a C.O. measurement.....	260
C.O. catheter selections	260
Selecting the C.O. injectate probe type	261
Setting a C.O. right ventricular ejection fraction (REF) measurement.....	261
Selecting the C.O. scale.....	261
Selecting what to show with C.O.	262
Setting the Tblood alarm	262
Adjusting the SvO ₂ from the cardiac output menu	262
Editing calculations.....	262
Adjusting the wedge from the cardiac output menu.....	263
Stopping the cardiac output measurement.....	263
C.O. practicalities.....	263
Cardiac output washout curve.....	263
How to improve the C.O. accuracy.....	263
C.O. troubleshooting.....	264
15 Mixed venous oxygen saturation (SvO₂).....	267
SvO ₂ compatibility limitations	267
SvO ₂ safety precautions	267
SvO ₂ warnings	267
SvO ₂ measurement limitations	267
SvO ₂ points to note	268
SvO ₂ measurement setup	268
SvO ₂ equipment to patient connection.....	268
Checking the SvO ₂ measurement	268
SvO ₂ measurement on screen.....	268
Using the SvO ₂ measurement.....	269
SvO ₂ calibration in vitro	269

Calibrating SvO ₂ in vivo.....	270
Updating the Hb value for SvO ₂ measurement.....	270
Setting the SvO ₂ alarms.....	270
Stopping the SvO ₂ measurement.....	270
SvO ₂ measurement description.....	271
SvO ₂ troubleshooting.....	271
16 Airway gases.....	273
Airway gases compatibility limitations.....	273
Airway gases safety precautions.....	273
Airway gases warnings.....	273
Airway gases cautions.....	275
Airway gases measurement limitations.....	275
Airway gases points to note.....	275
Airway gases measurement setup.....	276
Airway gases equipment to patient connections with CARESCAPE respiratory modules.....	276
Airway gases equipment to patient connections with compact airway modules, anesthesia setup.....	277
Airway gases equipment to patient connections with compact airway modules, critical care setup.....	277
Airway gases equipment to patient connections with E-miniC, critical care setup.....	278
Airway gases measurement setup.....	278
CARESCAPE respiratory module connectors.....	279
Compact airway module connectors.....	279
E-miniC module connectors.....	280
E-miniC indications for use.....	280
Airway gases alternative patient connections.....	280
Checking the airway gases measurement.....	281
Airway gases parameters.....	282
Using the E-modules for CO ₂ measurement.....	284
Available menu selections.....	284
Selecting the CO ₂ scale.....	284
Selecting the CO ₂ sweep speed.....	284
Setting CO ₂ limit alarms.....	284

Deactivating the apnea alarm	284
Apnea alarms' deactivation with the pause audio key.....	285
Selecting what to show with EtCO ₂	285
Selecting the FiO ₂ level.....	285
Selecting the N ₂ O level.....	285
Using the CARESCAPE respiratory modules and compact airway modules for O ₂ measurement.....	286
Selecting the O ₂ scale	286
Selecting the O ₂ sweep speed	286
Setting O ₂ alarms	286
Using the CARESCAPE respiratory modules and compact airway modules for AA and N ₂ O measurement	286
Selecting the agent scale.....	286
Selecting the agent sweep speed	286
Setting agent limit alarms	287
Gases alarm priorities.....	287
Preventing operating room pollution.....	287
Scavenging through the ventilator reservoir.....	287
Scavenging through the anesthesia gas scavenging system.....	287
Connecting directly to the scavenging system	287
Stopping the airway gases measurement	288
Calibrating airway gases.....	288
Basics of airway gases measurement.....	289
Airway gases measurement description, CARESCAPE respiratory modules and compact airway modules	289
Airway gases measurement description, E-miniC	289
Sidestream gas sampling	290
Minimum Alveolar Concentration (MAC).....	290
MAC and MACage.....	290
References used for MAC and MACage values.....	291
MAC values of different anesthetics in oxygen	291
MAC values of different anesthetics in 65% N ₂ O	292
ET balance gas, CARESCAPE respiratory modules and compact airway modules	292

Automatic agent identification with E-sCAiO, E-sCAiOV, E-CAiO, E-CAiOV and E-CAiOVX modules	293
Basics of CO ₂ measurement.....	293
Normal CO ₂ waveform.....	293
The origin of the CO ₂ waveform	293
Dips in capnogram.....	294
Oxygen measurement interpretation, CARESCAPE respiratory modules and compact airway modules.....	295
Airway gases practicalities.....	295
Ventilation management.....	295
Prevention of the breathing system contamination	296
How to prevent effects of humidity.....	296
Oxygen delivery, CARESCAPE respiratory modules and compact airway modules.....	296
Level of anesthesia: E-sCAiO, E-sCAiOV, E-CAiO, E-CAiOV, E-CAiOVX.....	297
Airway gases troubleshooting.....	297
17 CO₂ with CAPNOSTAT Mainstream, CapnoFlex LF, and Dual CO₂ modules.....	299
CO ₂ compatibility limitations	299
CO ₂ safety precautions.....	299
CO ₂ warnings.....	299
CO ₂ cautions.....	301
CO ₂ points to note.....	301
CO ₂ measurement setup	301
Equipment connection with CAPNOSTAT Mainstream module	301
Preparing the setup for CAPNOSTAT Mainstream module.....	302
Calibrating the CAPNOSTAT Mainstream sensor	302
Calibrating the CAPNOSTAT Mainstream adapter	303
Equipment connection with CapnoFlex LF module.....	303
Preparing the setup for CapnoFlex LF module.....	304
Calibrating the CapnoFlex LF adapter	304
Equipment connection with Dual CO ₂ module	304
Preparing the sidestream setup with Dual CO ₂ module	305
Calibrating the Dual CO ₂ sensor	306

Calibrating the Dual CO ₂ adapter	306
Using the CO ₂ measurement.....	307
Available menu selections	307
Selecting the CO ₂ scale	307
Selecting the CO ₂ sweep speed.....	307
Setting CO ₂ limit alarms	307
Deactivating the apnea alarm	307
Apnea alarms' deactivation with the pause audio key.....	308
Selecting CO ₂ average	308
Selecting the FiO ₂ level.....	308
Selecting the N ₂ O level.....	308
Selecting the pump on or off	308
Selecting apnea alarm limit.....	309
Preventing operating room pollution with CAPNOSTAT Mainstream, Dual CO ₂ , and CapnoFlex LF modules.....	309
Scavenging to scavenging systems.....	309
Stopping the CO ₂ measurement	309
Basics of CO ₂ measurement.....	309
Normal CO ₂ waveform.....	309
The origin of the CO ₂ waveform	310
Dips in capnogram.....	310
CO ₂ measurement practicalities	311
Ventilation management.....	311
Prevention of the breathing system contamination	312
How to prevent effects of humidity.....	312
AquaKnot with the Dual CO ₂	312
CAPNOSTAT Mainstream and Dual CO ₂ sensor placement.....	312
CO ₂ troubleshooting.....	312
18 Patient Spirometry.....	315
Patient Spirometry compatibility.....	315
Patient Spirometry safety precautions	315
Patient Spirometry warnings.....	315
Patient Spirometry cautions	315
Patient Spirometry limitations.....	315

Patient Spirometry points to note	316
Patient Spirometry measurement setup	316
Patient Spirometry equipment to patient connection	316
Patient Spirometry module keys	316
Preparing the Patient Spirometry measurement	317
Checking the Patient Spirometry measurement	317
Using the Patient Spirometry measurement	317
Selecting the Patient Spirometry sensor type	317
Selecting the Patient Spirometry scaling type	317
Selecting the Patient Spirometry scaling speed	318
Selecting the Patient Spirometry scales	318
Selecting the Patient Spirometry sweep speeds	318
Selecting the displayed Patient Spirometry volume type	318
Changing the Patient Spirometry loop type	319
Saving Patient Spirometry reference loops	319
Selecting a Patient Spirometry reference loop	319
Erasing a Patient Spirometry reference loop	319
Printing a Patient Spirometry loop	319
Setting Paw alarm limits	320
Setting MV/Vent alarm limits	320
Patient Spirometry measurement basics	320
Patient Spirometry measurement description	320
D-lite(+)/Pedi-lite(+) flow sensor	321
Patient Spirometry parameters	321
Patient Spirometry loops and waveforms	326
Patient Spirometry practicalities	328
Patient Spirometry troubleshooting	329
19 Gas exchange	331
Gas exchange compatibility limitations	331
Gas exchange safety precautions	331
Gas exchange warnings	331
Gas exchange cautions	332
Gas exchange measurement limitations	332
Gas exchange points to note	332

Gas exchange measurement setup.....	333
Gas exchange equipment to patient connection.....	333
Checking the gas exchange measurement.....	334
Using the gas exchange measurement	334
Selecting the gas exchange sensor type.....	334
Selecting EE and RQ averaging time.....	334
Weighted VO ₂ and VCO ₂	334
Stopping the gas exchange measurement	335
Gas exchange measurement basics	335
Gas exchange measurement description	335
How to interpret the gas exchange values	335
Gas exchange practicalities	338
Gas exchange troubleshooting.....	339
20 Entropy.....	341
Entropy compatibility.....	341
Entropy safety precautions	341
Entropy warnings	341
Entropy cautions	342
Entropy indications for use.....	342
Entropy measurement limitations	342
Entropy points to note	343
Entropy measurement setup.....	343
Entropy equipment to patient connection.....	343
Entropy module keys.....	344
Preparing the patient for Entropy measurement.....	344
Checking the Entropy measurement	344
Using the Entropy measurement.....	345
Selecting the display format for Entropy	345
Selecting the Entropy scale	345
Selecting the EEG sweep speed	345
Showing Entropy microtrend.....	345
Selecting the Entropy trend length.....	346
Using the manual Entropy sensor check.....	346
Using the automatic Entropy sensor check.....	346

Bypassing the Entropy sensor check	346
Setting Entropy alarm limits	346
Stopping the Entropy measurement.....	347
Entropy measurement basics	347
Entropy measurement description	347
Entropy parameters	347
Entropy frequency and display ranges	347
How to interpret the Entropy values	347
Relation of Entropy values to EEG and patient status.....	348
Entropy range guidelines.....	349
Burst suppression ratio (BSR).....	349
Entropy practicalities	349
Entropy troubleshooting.....	350
Entropy reference studies.....	351
Entropy reference studies supporting reduction of drugs.....	351
Entropy reference studies supporting titration of drugs	351
Reference studies regarding pediatric use of Entropy.....	352
21 Neuromuscular transmission.....	353
NMT compatibility	353
NMT safety precautions.....	353
NMT warnings.....	353
NMT cautions.....	354
NMT measurement limitations.....	354
NMT points to note.....	354
Checking the NMT measurement	354
NMT measurement setup	355
NMT equipment to patient connection.....	355
NMT module keys	355
Preparing the patient for NMT measurement	355
NMT alternative connections.....	356
NMT graphical trends on the monitor screen	357
Using the NMT measurement	357
Starting the NMT measurement.....	357
Changing the NMT stimulus current	357

Changing the NMT cycle time.....	358
Changing the NMT pulse width	358
Adjusting the NMT beep volume	358
Using the NMT recovery note	358
Measuring deep relaxation.....	358
Continuing the NMT measurement.....	358
Restarting the NMT measurement in OR after induction	359
Stopping the NMT measurement	359
NMT alternative uses	359
Local nerve and plexus localization	359
NMT measurement basics.....	360
NMT measurement description.....	360
How to interpret the NMT values.....	361
NMT practicalities.....	362
NMT troubleshooting	362
22 EEG and auditory evoked potentials	365
EEG compatibility	365
EEG safety precautions.....	365
EEG warnings.....	365
EEG cautions.....	366
EEG indications for use	366
EEG measurement limitations.....	366
EEG points to note.....	366
EEG measurement setup	367
EEG equipment to patient connection	367
EEG module keys	367
EEG electrode sites.....	367
Connecting the EEG leadset	368
Attaching EEG electrodes within hair area	368
Attaching EEG electrodes outside hair area	368
Attaching EEG needle electrodes	369
Preconfigured EEG leadsets.....	369
BASIC montage.....	369
GENERAL montage.....	370

Checking the EEG measurement.....	370
EEG measurement on the monitor screen	370
Using the EEG measurement	371
Starting the EEG measurement.....	371
Selecting your own EEG montage.....	371
Selecting the EEG scale.....	371
Selecting the EEG sweep speed	371
Selecting EEG numeric parameters	371
Selecting the SEF%.....	372
Selecting the EEG frequency scale.....	372
Selecting the EEG impedance cycle time.....	372
Selecting the CSA view.....	372
Selecting the time scale for CSA.....	372
Selecting the EEG numerical view	372
Checking EEG electrodes	373
Defining an EEG montage.....	373
Printing EEG	373
Stopping the EEG measurement	373
EEG practicalities.....	374
EEG measurement description.....	374
EEG frequency bands.....	374
Compressed spectral array (CSA).....	375
How to interpret the EEG values.....	375
Normal EEG frequencies	376
Abnormal EEG characteristics.....	376
EEG reactivity.....	376
Examples of typical EEG patterns	376
Technical artifact and EEG.....	377
EEG troubleshooting	378
Measuring auditory evoked potentials (AEP).....	379
Preparing the patient for AEP measurement	379
AEP montage.....	380
Using the AEP measurement.....	380
Starting the AEP measurement.....	380

Selecting the AEP channels	380
Selecting the number of AEP responses	380
Selecting the AEP stimulus frequency.....	380
Selecting the AEP stimulus intensity	381
Selecting the AEP sweep length	381
Selecting the AEP filter	381
Selecting the AEP cycle	381
Selecting the AEP size	381
Saving AEP responses	382
Selecting a reference AEP	382
Erasing an AEP reference.....	382
Printing an AEP report.....	382
Stopping the AEP measurement	382
AEP practicalities.....	383
AEP measurement description	383
Main peak categories (AEP).....	383
Examples of typical AEP patterns.....	383
AEP troubleshooting.....	384
23 Bispectral index.....	385
BIS compatibility.....	385
BIS safety precautions	385
BIS warnings.....	385
BIS cautions	386
BIS indications for use	387
BIS measurement limitations	387
BIS points to note	387
BIS measurement setup	388
BIS equipment to patient connection	388
BIS module keys	388
Preparing the patient for BIS measurement.....	388
Checking the BIS measurement.....	388
BIS measurement on the monitor screen.....	389
Using the BIS measurement.....	389
Selecting the BIS waveform size.....	389

Selecting the EEG sweep speed	389
Selecting the BIS smoothing rate	389
Setting BIS filters	389
Setting BIS alarm limits	390
Using the automatic BIS sensor check	390
Using the manual BIS sensor check.....	390
Testing the BISx	390
Stopping the BIS measurement.....	390
How to interpret the BIS values.....	391
BIS troubleshooting.....	391
24 Laboratory data	393
About laboratory values	393
Viewing laboratory data	393
Selecting the blood sample site for laboratory values	393
Selecting the blood sample time for laboratory values.....	394
Temperature correction.....	394
Selecting the type of temperature correction	394
Entering or loading laboratory values	395
Printing laboratory values	395
25 Calculations	397
About calculations	397
Viewing calculation values	397
Source data for calculations	397
Selecting source data for oxygenation calculations.....	398
Selecting source data for ventilation calculations.....	398
Estimated values in oxygenation calculations	398
Estimated values in hemodynamic calculations.....	398
Selecting the PCWP source.....	398
Indexing parameters for hemodynamic and oxygenation calculations	399
Editing calculation input values	399
Saving calculation values	399
Viewing saved calculations	399
Printing hemodynamic, oxygenation, or ventilation calculations.....	400

Printing all calculation trends.....	400
26 Drug calculations.....	401
About drug calculations	401
Calculations menu description.....	402
Drug calculator	403
Calculating drug doses	403
Adding a new drug name	403
Printing drug dose calculations.....	404
Titration table	404
Calculating drug titrations.....	404
Printing the titration table.....	404
Resuscitation medications	405
Calculating resuscitation medication doses.....	405
Printing resuscitation medication doses	405
27 Trends.....	407
Monitor and module compatibility.....	407
Trend views.....	407
System warning safety messages	407
Graphic trends.....	407
Viewing graphic trends	407
Graphic trend symbols.....	408
Changing the time scale of graphic trends	408
Changing the graphic trend scales	409
Printing currently viewed graphic trends.....	409
Printing all graphic trend data.....	409
Graphic trend resolution and the high-resolution license	409
Numeric trends.....	410
Viewing numeric trends	410
Changing the time interval of numeric trends	410
Printing numeric trends	410
Invasive pressure trends.....	410
Heart rate (HR) trends	411
Gas consumption.....	411
Viewing gas consumption data.....	411

Printing gas consumption data	411
Minitrend split screen.....	411
Minitrend view	411
Selecting the minitrend to screen	412
Modifying the minitrend length	412
Selecting high-resolution contents to minitrend.....	413
Removing minitrend from the screen	413
Time change during a patient case	413
28 Snapshots and events	415
Description of snapshots.....	415
Snapshot configuration	415
Manually created snapshots.....	415
Creating automatic snapshots.....	415
Viewing snapshots.....	416
Changing the snapshot time scale	416
Changing snapshot trend scales	417
Printing snapshot pages.....	417
Selecting snapshots to print automatically.....	417
Selecting spirometry loops to print with snapshots.....	417
Erasing snapshots and trends.....	417
Snapshots and alarm history	418
Snapshot transfer to PDM	418
ST snapshots	418
Creating ST snapshots manually.....	418
Viewing ST snapshots	419
Printing ST snapshots.....	419
Erasing ST-snapshots.....	419
Events	419
Description of events	419
Automatic events	419
Viewing events	420
Sorting events.....	420
Creating events manually.....	420
Annotating events.....	420

Deleting events.....	421
Undeleting events	421
Printing events.....	421
29 Printing.....	423
Printing options	423
Laser printers	423
Recorders.....	424
PRN 50-M recorder (B850 only)	424
XE-50 recorder (B650 only)	425
Printing device selections	425
Changing printer	425
Checking the print status.....	426
Printing waveforms.....	426
Printing waveforms for an arrhythmia alarm.....	426
Printing waveforms for other than arrhythmia alarms	427
Setting the print delay.....	427
Setting the print duration	427
Setting the print speed.....	428
Selecting waveforms to print.....	428
Printing from the main display	428
Printing from the waveforms window.....	428
Stopping the waveform printing	428
Printing trends.....	429
Configuration of numeric trends for printing	429
Automatic printing of events and snapshots	429
Printing trends manually.....	429
Printing reports	429
Printing and patient discharge.....	429
Configuring a trend report.....	429
Printing a trend report	430
Printing individual reports.....	430
Care report printouts	430
Printing calculations	430
Printing Hemo, Oxy, or Vent calculations.....	430

Printing Hemo, Oxy, or Vent calculation trends.....	431
Printing drug calculations.....	431
Printing drug calculator	431
Printing titration table	431
Printing laboratory data and parameter printouts.....	431
Printing laboratory data	431
Parameter printouts.....	431
Print header information	432
Laser printer print header.....	432
Recorder print header.....	432
30 Viewing other monitored patients.....	433
About viewing other monitored patients.....	433
Automatic view of remote beds in alarm	434
Selecting the alarm notification type.....	434
Selecting the notifying alarm priority level	434
Changing the settings for multiple beds.....	435
Next alarming remote bed to screen.....	435
Viewing remote patient beds	435
Audio pause for a remote patient bed alarms.....	436
Manual printing of remote bed waveforms	436
31 Interfacing with peripheral devices	437
Interfacing safety precautions.....	437
Interfacing warnings.....	437
Interfacing cautions.....	437
Compatible peripheral devices	438
Unity Network Interface Device (ID).....	438
Software compatibility.....	438
About the Unity Network Interface Device (ID).....	438
Unity Network Interface Device (ID) interconnection.....	438
Unity Network Interface Device (ID) serial port indicator lights.....	439
Peripheral device limit alarms	440
Peripheral device parameter data	440
Peripheral device data presentation and menus.....	441
32 Cleaning and care.....	443

Cleaning and care safety precautions.....	443
Cleaning and care warnings.....	443
Cleaning and care cautions.....	444
Disposal safety precautions	444
Disposal warnings.....	444
Disposal cautions.....	444
Cleaning and care schedules	444
Daily checks.....	444
Monthly checks.....	445
Check every two months	445
Check every six months.....	445
Once a year checks.....	445
Regular calibration checks	445
Cleaning and care points to note.....	445
Permitted detergents.....	446
Permitted disinfectants.....	446
Cleaning and care instructions	446
Setting the touchscreen off for cleaning	446
Cleaning non-applied parts, general instructions.....	446
Barcode reader cleaning instructions.....	447
Keyboard and mouse cleaning instructions.....	447
Cleaning applied parts, general instructions.....	447
Reusable D-lite and Pedi-lite sensor cleaning instructions	448
D-fend(+), D-fend Pro(+), and Mini D-fend water trap care instructions	448
CAPNOSTAT sensor and adapter cleaning instructions	448
How to store PDM and PSM.....	448
Monitor battery care	449
Replacing the monitor battery	449
Battery recycling	449
PDM battery care	449
About PDM battery charging.....	449
Replacing the PDM battery.....	450
Battery recycling	450

About the internal lithium battery.....	450
33 Messages	451
Messages related to ECG measurement	451
Messages related to impedance respiration measurement	456
Messages related to SpO ₂ measurement.....	457
Messages related to NIBP measurement	460
Messages related to invasive pressures measurement	463
Messages related to temperature measurement.....	469
Messages related to cardiac output measurement	470
Messages related to SvO ₂ measurement	473
Messages related to gases measurement	476
Messages related to spirometry measurement.....	481
Messages related to gas exchange measurement	483
Messages related to Entropy measurement	484
Messages related to NMT measurement.....	486
Messages related to EEG and AEP measurements.....	488
Messages related to BIS measurement.....	489
Messages related to TC measurement.....	491
Messages related to trends, snapshots, and laboratory data	492
Messages related to various situations	493
34 Abbreviations	501
List of abbreviations.....	501
A Skills checklist	517
System introduction.....	517
Starting and ending	517
Monitoring basics.....	518
Alarms.....	519
Trends	520
Snapshots and events	520
ECG.....	521
Impedance respiration	522
Pulse oximetry (SpO ₂).....	523
Non-invasive blood pressure.....	524
Invasive pressures.....	525

Temperature.....	525
Cardiac output	526
Mixed venous oxygen saturation (SvO ₂)	527
Airway gases	527
CO ₂ with CAPNOSTAT Mainstream, CapnoFlex LF, and Dual CO ₂ modules.....	528
Patient Spirometry	529
Gas exchange	529
Entropy.....	530
Neuromuscular transmission.....	530
EEG and AEP	531
BIS	532

1

About this manual

Intended use of this manual

This manual is an integral part of the device and describes its intended use. It should always be kept close to the equipment. Observance of the manual is a prerequisite for proper performance and correct operation and ensures patient and user safety. Information which refers only to certain versions of the product(s) is accompanied by the model number(s) of the product(s) concerned. The model number is given on the device plate of the product.

Intended markets of this manual

This manual is not intended for other than U.S. FDA-regulated markets because information regarding monitors' intended use is different in those countries.

Intended audience of this manual

This manual is intended for clinical professionals. Clinical professionals are expected to have a working knowledge of medical procedures, practices and terminology required to provide patient care. Using the device should never replace nor impede the human intervention and required patient care provided by clinical professionals.

Training requirements

No product-specific training is required for the use of the CARESCAPE modular monitors.

Manual conventions

This manual uses the following styles to emphasize text or indicate action.

Item	Description
bold	Indicates hardware terms.
<i>bold italic</i>	Indicates software terms.
<i>italic</i>	Indicates terms for emphasis.
>	Indicates menu options to select consecutively.
GE	For technical documentation purposes, the abbreviation GE is used for the legal entity names, GE Medical Systems <i>Information Technologies</i> , Inc. and GE Healthcare Finland Oy.

Item	Description
select	The word select means choosing and confirming.
NOTE	Note statements provide application tips or other useful information.

Monitor naming conventions

In this manual, the CARESCAPE Monitor B850 and CARESCAPE Monitor B650 are referred to as “the monitor” when a function or a feature applies to both. For describing monitor-specific issues, the monitors are referred to as B850 and B650, respectively. Where possible, the following icons are also used to help identify the monitor:

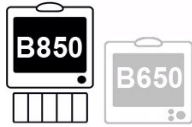
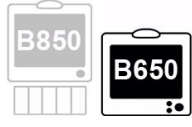
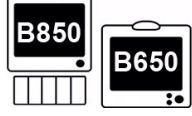
Icon	Explanation
	B850 only.
	B650 only.
	B850 and B650 both.

Acquisition module naming conventions

In this manual, the following naming conventions are used to refer to different modules and module categories:

- PDM: Patient Data Module
- PSM: Patient Side Module, E-PSM and E-PSMP
- E-modules: All modules with the prefix E-. In parameter chapters, E-modules refers to those modules that measure the parameter(s) in question.
- Cardiac output and SvO₂ E-modules: E-COP, E-COPsv
- Pressure E-modules: E-P, E-PP, E-PT
- CARESCAPE respiratory modules: E-sCO, E-sCOV, E-sCAiO, E-sCAiOV
- Compact airway modules: E-CO, E-COV, E-COVX, E-CAiO, E-CAiOV, E-CAiOVX.
- Single-width airway module: E-miniC
- Specialty E-modules: E-NMT, E-EEG, E-BIS and E-ENTROPY
- SpO₂ E-modules: E-NSATX, E-MASIMO
- TRAM: TRAM modules 451, 451M, 451N, 451N5, 851, 851M, 851N, 851N5. These modules are compatible with the B850 only.
- Tram-Rac: Single-parameter Tram-Rac modules measuring BP, SpO₂, SpO₂ Masimo, Capnostat CO₂, Dual CO₂. These modules are compatible with the B850 only.

Illustrations and names

This manual uses illustrations as examples only. Illustrations in this manual may not necessarily reflect all system settings, features, configurations, or displayed data.

Names of persons, institutions, and places and related information are fictitious; any similarity to actual persons, entities, or places is purely coincidental.

Related documents

- CARESCAPE Monitors B850 and B650 Supplemental Information Manual
- CARESCAPE Monitor B850 Technical Manual
- CARESCAPE Monitor B650 Technical Manual
- Module Frames and Modules Technical Manual
- TRAM and Tram-Rac Modules Supplemental Information for CARESCAPE Monitor B850
- CARESCAPE Network Configuration Guide
- Marquette 12SL ECG Analysis Program Physician's Guide
- CARESCAPE Modular Monitors Mounting Solutions
- User documentation for displays
- Unity Network Interface Device (ID) Operator's Manual
- iCentral and iCentral Client User's Reference Manual
- CIC Pro Clinical Information Center Operator's Manual

Ordering manuals

A paper copy of this manual will be provided upon request. Contact your local GE representative and request the part number on the first page of the manual.

Trademarks

GE, GE Monogram, and CARESCAPE are trademarks of General Electric Company.

iPanel is a trademark of General Electric Company or one of its subsidiaries.

12RL, Aqua-Knot, DINAMAP, IntelliRate, Multi-Link, MUSE, TRAM, Tram-Rac, Trim Knob, and UNITY NETWORK are trademarks of GE Medical Systems *Information Technologies*, Inc.

D-lite, D-fend, Entropy, and Ohmeda are trademarks of GE Healthcare Finland Oy.

TruSignal is a trademark of Datex-Ohmeda, Inc.

Third party trademarks

NELLCOR is a trademark of Covidien AG.

Covidien is a trademark of Covidien AG.

Masimo SET is a trademark of Masimo Corporation.

Manufacturer responsibility

GE is responsible for the effects on safety, reliability, and performance of the equipment only if:

- Assembly operations, extensions, readjustments, modifications, servicing, or repairs are carried out by authorized service personnel.
- The electrical installation of the relevant room complies with the requirements of the appropriate regulations.
- The equipment is used in accordance with the instructions for use.

Safety

Safety message signal words

Safety message signal words designate the severity of a potential hazard.

DANGER	Indicates a hazardous situation that, if not avoided, will result in death or serious injury.
WARNING	Indicates a hazardous situation that, if not avoided, could result in death or serious injury.
CAUTION	Indicates a hazardous situation that, if not avoided, could result in minor or moderate injury.
NOTICE	Indicates a hazardous situation not related to personal injury that, if not avoided, could result in property damage.

System safety

System safety messages apply to the entire system. Safety messages specific to parts of the system are found in the relevant section.

System warning safety messages

The following warning safety messages apply to this monitoring system.

Accessories warnings

WARNING	Single-use products are not designed to be reused. Reuse may cause a risk of cross-contamination, affect the measurement accuracy and/or system performance, and cause a malfunction as a result of the product being physically damaged due to cleaning, disinfection, re-sterilization and/or reuse.
WARNING	Use only approved accessories, including mounts, and defibrillator-proof cables and invasive pressure transducers. For a list of approved accessories, see the supplemental information manual. Other cables, transducers and accessories may cause a safety hazard, damage the equipment or system, result in increased emissions or decreased immunity of the equipment or system or interfere with the measurement

WARNING — ELECTRIC SHOCK — Only use protected leadwires and patient cables with this monitor. The use of unprotected leadwires and patient cables creates the potential for making an electrical connection to ground or to a high voltage power source which can cause serious injury or death to the patient.

WARNING For detailed instructions and information regarding supplies and accessories, always refer to their own instructions for use.

Cables warnings

WARNING — CABLES — Route all cables away from patient's throat to avoid possible strangulation.

WARNING — SITE REQUIREMENTS — Do not route cables or tubing in a way that they may present a stumbling hazard.

WARNING — SAFETY GROUND — Remove power cord from the mains source by grasping the plug. Do not pull on the cable.

Defibrillation warnings

WARNING Do not touch the patient, table, bed, instruments, modules or the monitor during defibrillation.

WARNING — DEFIBRILLATOR PRECAUTIONS — Patient signal inputs labeled with the CF and BF symbols with paddles are protected against damage resulting from defibrillation voltages. To ensure proper defibrillator protection, use only the recommended cables and leadwires.

Electrical warnings

WARNING — POWER SUPPLY — The device must be connected to a properly installed power outlet with protective earth contacts only. If the integrity of the protective earth conductor is in doubt, disconnect the monitor from the power line (and use it with the battery option (B650) if available). If the installation does not provide for a protective earth conductor, disconnect the monitor from the power line. All devices of a system must be connected to the same power supply circuit. Devices which are not connected to the same circuit must be electrically isolated when operated.

WARNING — EXCESSIVE LEAKAGE CURRENT — Do not use a multiple socket outlet or extension cord.

WARNING — EXCESSIVE TOUCH CURRENT — To avoid excessive patient leakage current, do not simultaneously touch the patient and the electrical connectors located at the rear panel of the CPU unit or monitor, or within the module housing or frames.

WARNING — INTERFACING OTHER EQUIPMENT — Connect only items that are specified as part of the system and as compatible. For more information, see the supplemental information manual.

- WARNING** — EXCESSIVE LEAKAGE CURRENT — To avoid summation of leakage currents when interfacing the device with other equipment, the devices may only be interconnected with each other or to parts of the system when it has been determined by qualified biomedical personnel that there is no danger to the patient, the operator, or the environment as a result. In those instances where there is any element of doubt concerning the safety of the connected devices, the user must contact the manufacturers concerned (or other informed experts) for proper use. In all cases, safe and proper operation should be verified with the applicable manufacturer's instructions for use, and system standards IEC 60601-1-1 must be complied with.
- WARNING** Do not under any circumstances remove the grounding conductor from the power plug. Always check that power cord and plug are intact and undamaged
- WARNING** During intracardiac application of a device, a defibrillator and pacemaker whose proper functioning has been verified must be kept at hand.
- WARNING** If liquid has accidentally entered the system or its parts, disconnect the power cord from the power supply and have the equipment serviced by authorized service personnel.
- WARNING** — DISCONNECTION FROM MAINS — When disconnecting the device from the power line, remove the plug from the wall outlet first. Then you may disconnect the power cord from the device. If you do not observe this sequence, there is a risk of coming into contact with line voltage by inserting metal objects, such as the pins of leadwires, into the sockets of the power cord by mistake.
- WARNING** — INTRACARDIAC APPLICATION — When applying devices intracardially, electrically conductive contact with parts connected to the heart (pressure transducers, metal tube connections and stopcocks, guide wires, etc.) must be avoided in all cases. To prevent electrical contact, we recommend the following:
- always wear isolating rubber gloves,
 - keep parts that are conductively connected to the heart isolated from ground,
 - if possible, do not use tube fittings or stopcocks made of metal.

Equipment warnings

- WARNING** — EXPLOSION — Do not use this equipment in the presence of flammable anesthetics, vapors or liquids.

- WARNING** If an error message appears during operation, it is the licensed medical practitioner's responsibility to decide whether the unit is still suitable for patient monitoring. As a general rule, monitoring should only continue in extremely urgent cases and under the direct supervision of a licensed healthcare practitioner. The unit must be repaired before being used again on a patient. If an error message appears after power-up, the unit must be repaired before being used on a patient.
- WARNING** Ensure that modules are securely latched.
- WARNING** The parameter modules are not able to withstand unpacked drops from a height of 1 m without damage. If a module is dropped, please service it before taking it back into use.
- WARNING** If the frame or monitor is dropped, please service it before taking it back into use.

Site requirement warnings

- WARNING** — BEFORE INSTALLATION — Compatibility is critical to safe and effective use of this device. Please contact your local sales or service representative prior to installation to verify equipment compatibility.

System caution safety messages

The following caution safety messages apply to this monitoring system.

Loss of data

- CAUTION** LOSS OF DATA — Should the monitor at any time temporarily lose patient data, the potential exists that active monitoring is not being done. Close patient observation or alternate monitoring devices should be used until monitor function is restored. If the monitor does not automatically resume operation within 60 seconds, power cycle the monitor using the power on/off switch or on/standby button. Once monitoring is restored, you should verify correct monitoring state and alarm function.

Electrical caution

- CAUTION** — POWER REQUIREMENTS — Before connecting the device to the power line, check that the voltage and frequency ratings of the power line are the same as those indicated on the device's label. If this is not the case, do not connect the system to the power line until you adjust the device to match the power source. In U.S.A., if the installation of this equipment will use 240V rather than 120V, the source must be a center-tapped, 240V, single-phase circuit. This equipment is suitable for connection to public mains as defined in CISPR 11.

Site requirement cautions

CAUTION

— LOSS OF MONITORING — Leave space for circulation of air to prevent the monitor from overheating. The manufacturer is not responsible for damage to equipment caused by improperly vented cabinets, improper or faulty power, or insufficient wall strength to support equipment mounted on such walls.









Notice safety messages





The following notice safety message applies to this monitoring system:

NOTICE

The warranty does not cover damages resulting from the use of accessories and consumables from other manufacturers.

Safety symbols

Symbol	Explanation
	General warning. This symbol is identified by a yellow background, black triangular band, and a black symbol.
	General caution sign. IEC 60601-1, 2005 edition. This symbol is identified by a white background, black triangular band, and a black symbol.
	ATTENTION: Consult accompanying documents. IEC 60601-1, 1988 edition. This symbol is identified by a white background, black triangular band, and a black exclamation mark.
	Follow instructions for use. This symbol is identified by a blue background and a white symbol.
	Consult operating instructions. / Operating instructions.
	DANGER — Shock hazard. Dangerous voltage. To reduce the risk of electric shock, do not remove cover. Refer servicing to qualified service personnel. This symbol is identified by a yellow background, black triangular band, and a black symbol.
	Electrostatic sensitive device. Connections should not be made to this device unless ESD precautionary procedures are followed.
	Non-ionizing electromagnetic radiation. Interference may occur in the vicinity of this device.

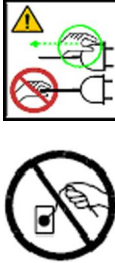
Symbol	Explanation
	Type BF (IEC 60601-1) protection against electric shock. Isolated (floating) applied part suitable for intentional external and internal application to the patient, excluding direct cardiac application.
	Type BF (IEC 60601-1) defibrillator-proof protection against electric shock. Isolated (floating) applied part suitable for intentional external and internal application to the patient, excluding direct cardiac application.
	Type CF (IEC 60601-1) protection against electric shock. Isolated (floating) applied part suitable for intentional external and internal application to the patient, including direct cardiac application.
	Type CF (IEC 60601-1) defibrillator-proof protection against electric shock. Isolated (floating) applied part suitable for intentional external and internal application to the patient including direct cardiac application.
	Safety ground. Remove power cord from the mains source by grasping the plug. Do not pull on the cable.

Indications for use

B850 indications for use

The CARESCAPE Monitor B850 is a multi-parameter high acuity patient monitor intended for use in multiple areas within a professional healthcare facility.

The CARESCAPE Monitor B850 is intended for use on adult, pediatric, and neonatal patients and on one patient at a time.

The CARESCAPE Monitor B850 is indicated for monitoring of:

- hemodynamic (including ECG, ST segment, arrhythmia detection, ECG diagnostic analysis and measurement, invasive pressure, non-invasive blood pressure, pulse oximetry, cardiac output (thermodilution), temperature, mixed venous oxygen saturation, and central venous oxygen saturation),
- respiratory (impedance respiration, airway gases (CO₂, O₂, N₂O, and anesthetic agents), spirometry, gas exchange), and
- neurophysiological status (including electroencephalography, Entropy, Bispectral Index (BIS), and neuromuscular transmission).

The CARESCAPE Monitor B850 also provides alarms, trends, snapshots and events, and calculations, and can be connected to displays, printers and recording devices.

The CARESCAPE Monitor B850 can be a stand-alone monitor or interfaced to other devices. It can also be connected to other monitors for remote viewing and to data management software devices via a network.

The CARESCAPE Monitor B850 is intended for use under the direct supervision of a licensed healthcare practitioner, or by personnel trained in proper use of the equipment in a professional healthcare facility.

The CARESCAPE Monitor B850 is not intended for use during MRI.

B650 indications for use

The CARESCAPE Monitor B650 is a multi-parameter patient monitor intended for use in multiple areas and intrahospital transport within a professional healthcare facility.

The CARESCAPE Monitor B650 is intended for use on adult, pediatric, and neonatal patients and on one patient at a time.

The CARESCAPE Monitor B650 is indicated for monitoring of:

- hemodynamic (including ECG, ST segment, arrhythmia detection, ECG diagnostic analysis and measurement, invasive pressure, non-invasive blood pressure, pulse oximetry, cardiac output (thermodilution), temperature, mixed venous oxygen saturation, and central venous oxygen saturation),
- respiratory (impedance respiration, airway gases (CO₂, O₂, N₂O, and anesthetic agents), spirometry, gas exchange), and
- neurophysiological status (including electroencephalography, Entropy, Bispectral Index (BIS), and neuromuscular transmission).

The CARESCAPE Monitor B650 also provides alarms, trends, snapshots and events, and calculations, and can be connected to displays, printers and recording devices.

The CARESCAPE Monitor B650 can be a stand-alone monitor or interfaced to other devices. It can also be connected to other monitors for remote viewing and to data management software devices via a network.

The CARESCAPE Monitor B650 is intended for use under the direct supervision of a licensed healthcare practitioner, or by personnel trained in proper use of the equipment in a professional healthcare facility.

The CARESCAPE Monitor B650 is not intended for use during MRI.

Indications for use safety precautions

Indications for use warnings

WARNING

Read all the safety information before using the monitor for the first time. This manual contains instructions necessary to operate this device safely and in accordance with its functions and intended use. This manual is intended for clinical professionals. Clinical professionals are expected to have a working knowledge of medical procedures, practices and terminology, as required for the monitoring of all patients.

WARNING

— SINGLE PATIENT USE — This equipment is designed for use on one patient at a time. Using this equipment to monitor different parameters on different patients at the same time compromises the accuracy of data acquired.

- WARNING** — INSTRUCTIONS FOR USE — For continued safe use of this equipment, it is necessary that the listed instructions are followed. However, instructions listed in this manual in no way supersede established medical practices concerning patient care.
- WARNING** — B650: INTRAHOSPITAL TRANSPORT — Vibrations during intrahospital transport may disturb SpO₂, ECG, impedance respiration, NIBP, and IP measurements.

Indications for use cautions

- CAUTION** U.S. Federal law restricts this device to sale by or on the order of a physician.
- CAUTION** — SUPERVISED USE — This equipment is intended for use under the direct supervision of a licensed healthcare practitioner.

Training requirements

No product-specific training is required for the use of the CARESCAPE modular monitors.

Electromagnetic compatibility

EMC warnings

- WARNING** Other equipment may interfere with the system, even if that other equipment complies with CISPR emission requirements.
- WARNING** Use only approved accessories, including mounts, and defibrillator-proof cables and invasive pressure transducers. For a list of approved accessories, see the supplemental information manual. Other cables, transducers and accessories may cause a safety hazard, damage the equipment or system, result in increased emissions or decreased immunity of the equipment or system or interfere with the measurement.
- WARNING** Pins of connectors identified with the ESD warning symbol should not be touched. Connections should not be made to these connectors unless electrostatic discharge (ESD) precautions are used.
- WARNING** Do not use the monitor in high electromagnetic fields (for example, during magnetic resonance imaging).

EMC cautions

- CAUTION** Use of known RF sources, such as cell/portable phones, or other radio frequency (RF) emitting equipment near the system may cause unexpected or adverse operation of this device/system. Consult qualified personnel regarding device/system configuration.

CAUTION The device/system should not be used adjacent to, or stacked with, other equipment. Consult qualified personnel regarding device/system configuration.

CAUTION — EMC — Magnetic and electrical fields are capable of interfering with the proper performance of the device. For this reason make sure that all external devices operated in the vicinity of the monitor comply with the relevant EMC requirements. X-ray equipment or MRI devices are a possible source of interference as they may emit higher levels of electromagnetic radiation. Changes or modifications to this device/system not expressly approved by GE may cause EMC issues with this or other equipment. This device/system is designed and tested to comply with applicable standards and regulations regarding EMC and needs to be installed and put into service according to the EMC information stated as follows: This device/system is suitable for use in all establishments other than domestic and those directly connected to the public low-voltage power supply network that supplies buildings used for domestic purposes. Mains power should be that of a typical commercial or hospital environment. Device is compliant to Class A.

ESD safety precautions

- To avoid electrostatic charges building up, it is recommended to store, maintain and use the equipment at a relative humidity of 30% or greater.
- To prevent applying a possible electrostatic charge to the ESD sensitive parts of the equipment, touch the metallic frame of the component or a large metal object located close to the equipment. When working with the equipment and specifically when the ESD sensitive parts of the equipment may be touched a grounded wrist strap intended for use with ESD sensitive equipment should be worn. See the documentation provided with the wrist straps for details of proper use. Floors should be covered by ESD dissipative carpets or similar. Non-synthetic clothing should be used when working with the component.

3

System introduction

Monitor and module compatibility limitations

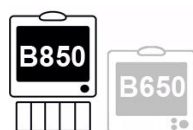

TRAM and Tram-Rac modules with the B850 only.

System safety precautions

System warnings

- | | |
|----------------|--|
| WARNING | Never install equipment above the patient. |
| WARNING | Operation of the monitor outside the specified performance range may cause inaccurate results. |
| WARNING | — EXCESSIVE LEAKAGE CURRENT — A secondary display or printer that is a non-medical grade device and is used within the patient environment, must always be powered from an additional transformer providing at least basic isolation (isolating or separating transformer). Using without an isolating transformer could result in unacceptable enclosure leakage currents. |
| WARNING | — EXCESSIVE LEAKAGE CURRENT — Laser printers are UL 60950/IEC 60950 certified equipment, which may not meet the leakage current requirements of patient care equipment. This equipment must not be located in the patient environment unless the medical system standard IEC 60601-1-1 is followed. Do not connect a laser printer to a multiple socket outlet supplying patient care equipment. The use of multiple socket outlet for a system will result in an enclosure leakage current equal to the sum of all the individual earth leakage currents of the system if there is an interruption of the multiple socket outlet protective earth conductor. Consult your local service representative before installing a laser printer. |
| WARNING | — PHYSICAL INJURY — Take care when mounting devices to an IV pole. If a device is mounted too high the IV pole may become unbalanced and tip over. |

- WARNING** Do not touch the electrical connector located within the module housing or frame.
- WARNING** — B850: ELECTRIC SHOCK — Do not use the F7 Frame for standalone use. Ventilation holes on the F7 E-module Frame will be covered only if installed within an Aisys, Avance, or Aespire anesthesia machine.
- WARNING** — ELECTRIC SHOCK — Always unplug the grounded cables when not in use. Leaving them connected could result in an electric shock from the ground contact in the other end.
- WARNING** B650: To prevent liquids from entering the monitor, do not tilt the monitor more than +/-15 degrees.
- WARNING** — EXPLOSION OR FIRE — Using non-recommended batteries could result in injury/burns to the patients or users. Only use batteries recommended or manufactured by GE. The warranty can be voided if non-recommended batteries are used.
- WARNING** Do not incinerate a battery or store at high temperatures. Serious injury or death could result.
- WARNING** To prevent liquids from entering the display casing, do not tilt the display more than +/- 15 degrees.
- WARNING** Do not connect a monochrome display to the monitor. Visual alarm indicators may not appear properly.
- WARNING** B850: Using other displays than B850 system specific ones may result in loss of visual alarms and patient monitoring.
- WARNING** B650: Secondary displays will not sound the audible alarms. Keep the patient under close surveillance
- WARNING** Use only washable keyboard with at least IPX1 protection against ingress of water.

System caution

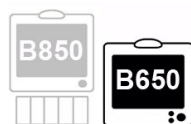

B650 only.

- CAUTION** To comply with the FCC RF exposure requirements, the monitor with the wireless network (WLAN) option must be operated with a separation distance of 20 cm or more from a person's body.

B850 system components

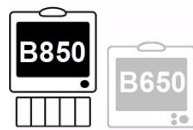

B850 only.

All components listed below can be used within the patient environment as long as an additional transformer providing at least basic isolation is used with non-medical grade secondary displays and printers.

Your system may not include all these components. Consult your local representative for the available components.



1. 19-inch display: Touchscreen display that provides abbreviated keypad and Trim Knob control. If a non-medical grade display is used as a secondary display within the patient environment it must always be powered from an additional transformer providing at least basic isolation.
2. Processing unit: Provides a link between parameter acquisition and input and output devices. The processing unit works with multi parameter acquisition devices.
3. Acquisition modules: Three types of acquisition modules can be used: PDM, E-modules, and TRAM module or single parameter Tram-Rac module.
4. The F7 Frame has seven module slots, and the F5 Frame has five module slots that support all E-module acquisition modules. It supports both PDM and PSM modules with a slide mount.
5. Module Tram-Racs: Tram-Rac housing (2 and 4A) acquires patient data for the monitor. It provides an interface between the monitor and the module or a single parameter Tram-Rac module.
6. Laser printer: This device may be connected to the monitor, network, or to a central station on the network. The laser printer can print waveforms, alarm waveforms, numeric trends, and reports. If it is used within the patient

environment it must always be powered from an additional transformer providing at least basic isolation.

7. PRN 50-M recorder: This device may be connected directly to the monitor or over the network to a remote monitor or central station. The recorder can print waveforms, alarm waveforms, and numeric trends.
8. Unity Network Interface Device (ID): Used with the monitor to communicate with other manufacturers' peripheral bedside devices, such as ventilators and gas delivery systems, to centralize patient data on one device.
9. Mouse.
10. Remote Alarm Box (nurse call system): Used to notify a remote location of patient alarms and system alarms.
11. Remote control and keypad: Used to provide all patient monitor controls on a portable component with a Trim Knob control.
12. Barcode reader: Used to scan a Technician ID and Patient Information Number from barcodes when admitting patients.
13. Keyboard: Allows data entry without using the on-screen keyboard or a touchscreen display.

B850 processing unit front view

Four M-port connectors are located on the processing unit. The M-ports are used to connect peripheral devices to the monitor.



1. Power indicator: Illuminates green when the power is turned on.
2. M-ports: Connect the remote control, PRN 50-M recorder, remote alarm box (remote nurse call), or a Unity Network Interface Device (ID) to the monitor.

B850 processing unit back view

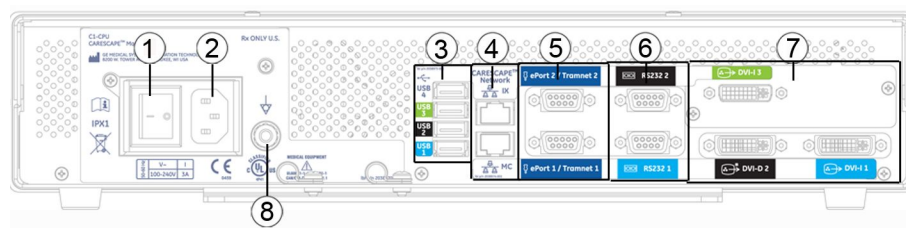

1. Power on/off switch.
2. Power inlet connector.
3. Four USB ports: For connecting the touchscreen display, remote control, keyboard, mouse, and barcode reader.

4. Ethernet: For connecting the MC and IX networks. The MC Network establishes communication and allows patient data to be sent to an optional CIC Pro Clinical Information Center. The IX Network provides access for example to the MUSE server, Citrix server, and IX printers.
5. Tram-Net and ePort: For connecting the PDM, E-module Frame, and Tram-Rac housing.
6. RS232: For connecting the touchscreen display.
7. DVI-1 supports a digital display and cloned analog display. DVI-2 supports only one digital display. DVI-3 (optional third video) supports a digital display and a cloned analog display (iPanel application only).
8. Ground plug: Provides equipotentiality.

B850 module frames F7 and F5

WARNING

Do not touch the electrical connector located within the module housing or frame.

WARNING

— B850: ELECTRIC SHOCK — Do not use the F7 Frame for standalone use. Ventilation holes on the F7 E-module Frame will be covered only if installed within an Aisys, Avance, or Aespire anesthesia machine.



1. Defibrillator synchronization

F5 and F7 E-module Frames provide an interface between the monitor and E-modules. Frames allow additional parameters to be monitored.

The F5 Frame has five module slots that support all E-module acquisition modules. It supports both PDM and PSM with a slide mount.

The F7 Frame has seven module slots, but it does not have a slide mount for the PDM or PSM. The PSM module may be interfaced to the F5 or F7 Frame with a cable when the Module Bus Adapter or Interface Module for PSM is used.

B850 Tram-Rac frames 2A and 4A



Tram-Rac housings (2A and 4A) acquire patient data for the monitor. They provide an interface between the monitor and a TRAM module or a single-parameter Tram-Rac module.

B650 system components

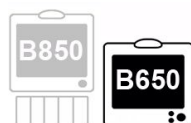

B650 only.

All components listed below can be used within the patient environment as long as an additional transformer providing at least basic isolation is used with non-medical grade secondary displays and printers.

Your system may not include all these components. Consult your local representative for the available components.



1. CARESCAPE Monitor B650
2. 19-inch display: Touchscreen display that provides abbreviated keypad and Trim Knob control. If a non-medical grade display is used as a secondary display

within the patient environment it must always be powered from an additional transformer providing at least basic isolation.

3. Laser printer: This device may be connected to the monitor, network, or to a central station on the network. The laser printer can print waveforms, alarm waveforms, numeric trends, and reports. If it is used within the patient environment it must always be powered from an additional transformer providing at least basic isolation.
4. Acquisition modules: Two types of acquisition modules can be used: PDM and E-modules.
5. Keyboard: Allows data entry without using the on-screen keyboard or a touchscreen display.
6. Mouse: Allows on-screen user selections and data entry.
7. Barcode reader: Used to scan a Technician ID and Patient Information Number from barcodes when admitting patients.
8. Remote control: Used to provide all patient monitor controls on a portable component with a Trim Knob control.
9. Unity Network Interface Device (ID): Used with the monitor to communicate with other manufacturers' peripheral bedside devices, such as ventilators and gas delivery systems, to centralize patient data on one device.

B650 monitor front panel

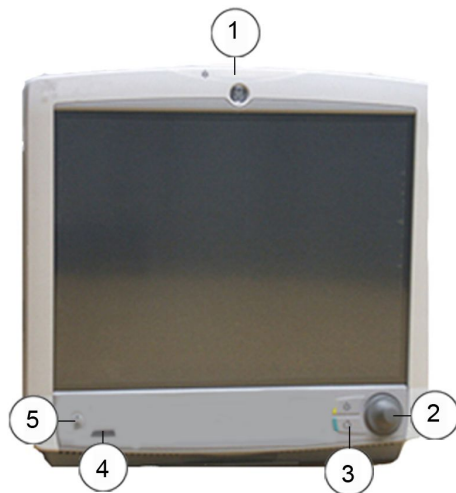

1. Alarm light
2. Trim Knob control
3. Abbreviated integrated keypad
4. Battery power/mains power indicators
5. On/standby

B650 monitor side views



- 1. Recorder *
 - 2. Module slot * for one double-width or two single-width modules
 - 3. Release switch for the pivoting module frame
 - 4. Defibrillator (ECG) and IABP synchronization (E-modules only)
- * = optional
- 1. Battery cover *
 - 2. Lock for battery cover
- * = optional

B650 monitor back panel

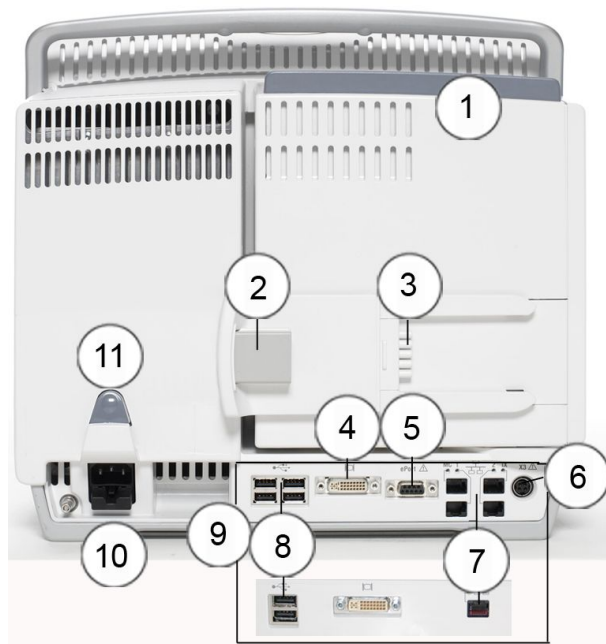

- 1. Pivoting module frame
- 2. Slide mount, connector for PDM

3. Slide mount, connector for PSM
4. Connector for secondary (clone) display
5. Connector for ePort (PDM cable) *
6. Connector for remote on/off *
7. Network connectors (one or four) *
8. USB ports (two or four)*
9. Panel options
10. Power and ground
11. Cable release switch

* = optional

B650 pivoting module frame

The pivoting module frame provides an interface between the monitor and acquisition modules. There are four pivoting module frame options available:

- Frame with PSM and PDM support
- Frame with PSM, PDM, and E-module support
- Frame with PSM, PDM, and recorder support
- Frame with PSM, PDM, E-module, and recorder support

Using the B650 pivoting module frame

WARNING

Do not touch the electrical connector located within the module housing or frame.

1. Press the pivoting module frame's release switch and use the rail on top of the frame to help you in moving the frame.



2. Keep the release switch pressed and turn the module frame to the position you prefer (0, 45 or 90 degrees). The module frame clicks when locked in position.



45 degrees

90 degrees

3. To return the pivoting module frame to its original position (0 degrees), press the release switch and turn the frame. Make sure that the frame locks in place and that the red color in the upper part of the switch is no longer visible.

Monitor battery

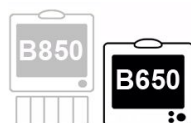

B650 only.

WARNING

— EXPLOSION OR FIRE — Using non-recommended batteries could result in injury/burns to the patients or users. Only use batteries recommended or manufactured by GE. The warranty can be voided if non-recommended batteries are used.

WARNING

Do not incinerate a battery or store at high temperatures. Serious injury or death could result.





WARNING

— PHYSICAL INJURY — Make sure the battery is completely inserted and the battery door is completely closed. Falling batteries could seriously or fatally injure neonatal or other vulnerable patients.

For information regarding the operation and charging time of the monitor battery, see the supplemental information manual.

If your B650 monitor has the optional battery slot, you can insert a lithium-ion battery and use the monitor on battery power.

The LED indicators on the monitor front panel indicate whether the monitor is being used on battery or mains power, and also whether the battery is charging, full or missing:

Front panel indicator	Meaning
	Monitor is operated on mains power.
	Monitor is operated on battery power.
	Battery failure or no battery.
	Battery is charging. The indicator goes off when the battery is fully charged.

Inserting and removing the B650 monitor battery

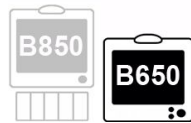

B650 only.

1. Open the battery slot by turning the lock 90 degrees clockwise:



2. Insert the battery with the test indicator side up and the connector end first all the way into the battery slot.
3. Push the cover back up and lock it in place by turning the lock 90 degrees counter-clockwise.
4. To remove the battery, open the battery slot and pull the battery out from the cord.

Checking the battery charge with monitor software

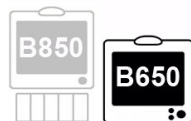

B650 only.

You can check the monitor battery status using the monitor software:



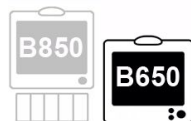

1. Select the battery status area in the upper right corner of the screen, or select **Monitor Setup > Battery Status**.
2. Check the **Monitor** battery status that appears.
3. If you wish to see more detailed battery information, select the **Advanced** tab.

Monitor battery charge symbols on screen

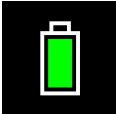
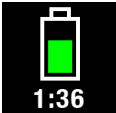

B650 only.

You can check the battery charge level from the monitor battery symbol on the right upper corner of the display.

Screen symbol	Meaning
	Monitor battery is full.
	Monitor battery (green). The higher the charge, the bigger the green bar within the symbol. Numbers indicate the remaining run time.
	Monitor battery (yellow). This symbol and a message indicating low battery charge appear when there is less than 20 minutes of run time left.
	Monitor battery (red). This symbol and a message indicating empty battery appear when there is less than 5 minutes of run time left.
	Monitor battery is charging. There is a white running bar inside the symbol.

Battery test button

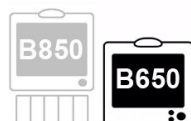

B650 only.

When the battery is not inserted into the monitor, you can check its status by using the TEST button on the battery itself. Push the button and check the green charging level indicators to see how much charge is left:

- Four LEDs illuminated: 75% to 100% of full-charge capacity.
- Three LEDs illuminated: 50% to 74.9% of full-charge capacity.
- Two LEDs illuminated: 25% to 49.9% of full-charge capacity.
- One LED illuminated: 10% to 24.9% of full-charge capacity.
- One LED flashing: < 10% of full-charge capacity.

Alarm light

The alarm light provides a visual alarm when an alarm condition is present. It indicates the highest priority alarm. The alarm light also provides a visual indicator when the audio alarms are paused or when they are off.



1. Audio alarm paused/off area
2. Alarm light area (cyan = low priority; yellow = medium priority; red = high priority)

Displays

- WARNING** To prevent liquids from entering the display casing, do not tilt the display more than +/- 15 degrees.
- WARNING** — ELECTRIC SHOCK — Always unplug the grounded cables when not in use. Leaving them connected could result in an electric shock from the ground contact in the other end.
- WARNING** B650: Secondary displays will not sound the audible alarms. Keep the patient under close surveillance
- WARNING** If there is a power failure (e.g., the supply mains is interrupted and the monitor battery fails), the monitor gives a continuous beeping alarm. This alarm remains active for as long as there is some residual power left, or until it is silenced with the pause audio alarm key, or until the power is reconnected.

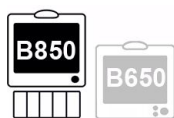

B850: The monitor supports up to three independent displays and two additional clone displays. The third display is only for use with the iPanel software application.

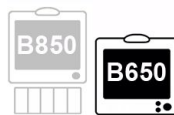

B650: The monitor supports one secondary (clone) display. The monitor itself has a 15" integrated display.

The GE 19-inch touchscreen display provides an integrated abbreviated keypad and a Trim Knob control. The displays integrate audible (B850 only) and visual alarms, and provide USB connectivity.

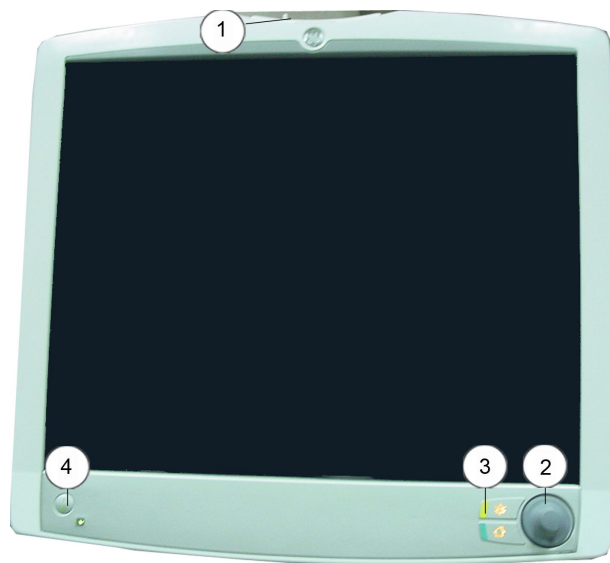

1. Alarm light
2. Trim Knob control
3. Integrated keypad
4. On/standby button

NOTE

The On/standby button does not turn off the USB connectors on the back of the display. To completely turn off the display, turn off the mains power switch on the back of the display.

Acquisition modules

You can use different types of acquisition modules with the monitor. They provide connection to the patient, process patient data signals, and send patient data signals to the monitor. For a complete list of compatible devices, see the supplemental information manual.

The module interface is disabled when the NICU software package is selected with other E-modules than E-NSATX or E-MASIMO.

PSMP front view

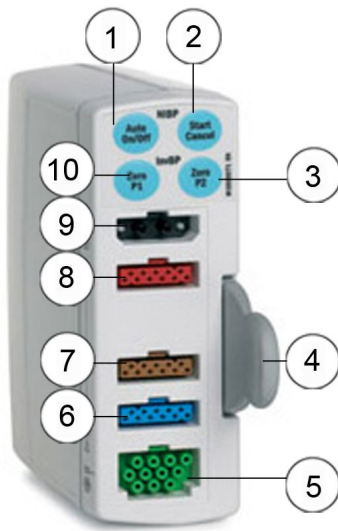

1. NIBP Auto On/Off
2. NIBP Start/Cancel
3. Zero P2
4. Tab for removing the module
5. ECG (imp.resp).
6. SpO₂
7. T1 to T2
8. P1 to P2
9. NIBP
10. Zero P1

PDM front view



1. ECG (imp.resp).
2. T1 to T2/C.O.
3. P1 to P4
4. SpO₂
5. NIBP
6. Communication indicator:
 - Illuminates yellow during boot-up and turns green after boot-up.
 - Flashes yellow if communication fails.
 - Not illuminated when no power is applied to the PDM.
7. Power indicator:
 - Illuminates yellow during boot-up and turns green after boot-up.
 - Illuminates green when the PDM module is powered by the monitor.
 - Illuminates green when the PDM battery is installed and power is applied to the PDM by pressing the Power On button.
 - Not illuminated when no power is applied to the PDM.
8. Dual function Power On and Zero All button
9. Defib/Sync
10. Tab for removing the module

The PDM module requires additional time to power up when used without the PDM battery. Do not interrupt the startup sequence by unplugging the PDM module.

WARNING — PHYSICAL INJURY — Do not install the PDM above a patient. Make sure the battery is completely inserted and the battery door is completely closed. Falling batteries could seriously or fatally injure neonatal or other vulnerable patients.

WARNING — PHYSICAL INJURY — Do not install the PDM above a patient. Leaks from the battery cells can occur under extreme conditions. The liquid is caustic to the eyes and skin. If the liquid comes in contact with eyes or skin, flush with clean water and seek medical attention.

WARNING — EXPLOSION OR FIRE — Using non-recommended batteries could result in injury/burns to the patients or users. Only use batteries recommended or manufactured by GE. The warranty can be voided if non-recommended batteries are used.

TRAM module front view



TRAM and Tram-Rac modules with the B850 only.

The following is an example of a TRAM module (TRAM 451N5). The front panel connectors are labeled. Some TRAM modules have different NIBP and SpO₂ connectors, but they are located in the same positions as those shown in the picture. TRAM module invasive pressure connectors are labeled BP and non-invasive blood pressure connectors are labeled NBP.



1. ECG (imp.resp.)
2. Temp/C.O.
3. BP1
4. BP2
5. BP3/4
6. NBP
7. SpO₂
8. Defib/Sync
9. Transport display
10. Power indicator

Single-parameter Tram-Rac front view



TRAM and Tram-Rac modules with the B850 only.

Single-parameter Tram-Rac modules collect the patient's physiological data and send it to the monitor for display. Single-parameter BP modules (in the picture) can only be placed in the bottom two slots (slot 3 and slot 4) of a Tram-Rac 4A housing.

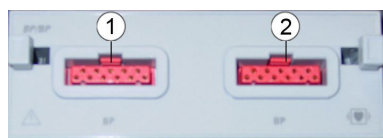

1. BP1
2. BP2

Modules and parameters

Hemodynamic multiparameter modules

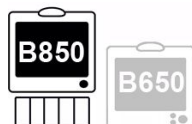

TRAM and Tram-Rac modules with the B850 only.

The hemodynamic multi-parameter acquisition modules are PSM, PDM, and TRAM.

PSM and PDM parameters

Parameter	E-PSM	E-PSMP	PDM (Masimo)**	PDM (Nellcor)**
ECG	up to 12 leads	up to 12 leads	up to 12 leads	up to 12 leads
Imp.respiration	x	x	x	x
Invasive pressures	-	2*	4*	4*
NIBP	x	x	x	x
Temperature	2*	2*	2* (or C.O.)	2* (or C.O.)
C.O.	-	-	x (or 2 temp.)	x (or 2 temp.)
SpO ₂ Masimo	-	-	x	-
SpO ₂ Nellcor	-	-	-	x
SpO ₂ GE	x	x	-	-
* A dual adapter cable is required to monitor two invasive pressure or temperature measurements on a single connector.				
** Different SpO ₂ cables are required for each type of SpO ₂ processing. The cable connectors are not interchangeable.				

TRAM 451, 451M, and 451N5 parameters

Parameter	451	451M	451N5
12 lead ECG analysis	x	x	x
Imp.respiration	x	x	x
Temp/C.O.	x	x	x
NIBP DINAMAP	x	x	x
IP	3 or 4*	3 or 4*	3 or 4*
SpO ₂ Masimo**	-	x	-
SpO ₂ Nellcor OxiMax**	-	-	x
SpO ₂ GE**	x	-	-

Parameter	451	451M	451N5
Defib/Sync	X	X	X
* A dual BP cable is required to monitor four invasive blood pressures.			
** Different SpO ₂ cables are required for each type of SpO ₂ processing. The cable connectors are not interchangeable.			

TRAM 851, 851M, 851N, and 851N5 parameters

Parameter	851	851M	851N	851N5
12 lead ECG analysis	X	X	X	X
Imp.respiration	X	X	X	X
Temp/C.O.	X	X	X	X
NIBP DINAMAP	X	X	X	X
SpO ₂ Masimo**	-	X	-	-
SpO ₂ Nellcor OxiMax**	-	-	-	X
Defib/Sync	X	X	X	X
** Different SpO ₂ cables are required for each type of SpO ₂ processing. The cable connectors are not interchangeable.				

Hemodynamic modules

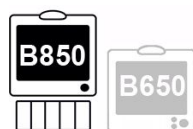

TRAM and Tram-Rac modules with the B850 only.

Hemodynamic modules are the cardiac output and SvO₂ E-modules, pressure E-modules, and Tram-Rac modules. E-modules offer a wide variety of parameter acquisition capability to the patient monitoring system.

E-COP and E-COPsv parameters

Parameter	E-COP	E-COPsv
Invasive pressures	1	1
SvO ₂	-	X
C.O.	x (also REF)	x (also REF)

E-PP, E-PT, and E-P parameters

Parameter	E-PP	E-PT	E-P
Invasive pressures	2	1	1
Temperature	-	2*	-
* A dual adapter cable is required to monitor two temperature measurements on a single connector.			

Tram-Rac hemodynamic parameters

Parameter	BP/Dual Temp*	Dual BP	BP	BP/C.O.
IP	1	2	1	1
* The monitor supports the invasive blood pressure measurement only				

Gas modules

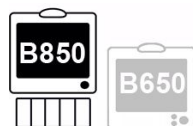

CAPNOSTAT Mainstream, CapnoFlex LF and Dual CO2 modules with the B850 only.

The gas acquisition modules provide measurements for gas parameters, anesthetic agents, Patient Spirometry, gas exchange, and metabolics. The gas acquisition modules are:

- E-sCO, E-sCOV, E-sCAiO, E-sCAiOV
- E-miniC
- E-CO, E-COV, E-COVX, E-CAiO, E-CAiOV, E-CAiOVX
- Tram-Rac modules CAPNOSTAT Mainstream, Dual CO2, CapnoFlex LF

E-module gas parameters

Module	CO ₂	N ₂ O	O ₂	Anesthetic agents	Agent ID
E-miniC	x	*	-	-	-
E-sCO	x	*	x	-	-
E-sCOV	x	*	x	-	-
E-CO	x	*	x	-	-
E-COV	x	*	x	-	-
E-COVX	x	*	x	-	-
E-sCAiO	x	x	x	x	x
E-sCAiOV	x	x	x	x	x
E-CAiO	x	x	x	x	x
E-CAiOV	x	x	x	x	x
E-CAiOVX	x	x	x	x	x

* The E-sCO, E-CO, E-sCOV, E-COV, and E-COVX modules automatically compensate for N₂O in realtime although N₂O values are not displayed on screen. The E-miniC requires manual selection from the monitor menu to compensate for N₂O.

Module	Patient Spirometry	Gas exchange
E-miniC	-	-
E-sCO	-	-
E-sCOV	x	-
E-CO	-	-

Module	Patient Spirometry	Gas exchange
E-COV	X	-
E-COVX	X	X
E-sCAiO	-	-
E-sCAiOV	X	-
E-CAiO	-	-
E-CAiOV	X	-
E-CAiOVX	X	X

Tram-Rac gas parameters

Parameter	CAPNOSTAT Mainstream	Dual CO ₂	CapnoFlex LF
CO ₂	X	X	X

SpO₂ E-modules

SpO₂ E-modules are the E-MASIMO and E-NSATX. They are compatible with all CARESCAPE modular monitors.

E-MASIMO and E-NSATX parameters

Parameter	E-NSATX*	E-MASIMO*
SpO ₂ Masimo	-	X
SpO ₂ Nellcor	X	-

* Different SpO₂ cables are required for each type of SpO₂ processing. The cable connectors are not interchangeable.

Tram-Rac SpO₂ parameters

Parameter	SpO ₂ Masimo	SpO ₂ GE
SpO ₂ GE	-	X
SpO ₂ Masimo	X	-

Specialty E-modules

Specialty E-modules are the E-NMT, E-EEG, E-BIS, and E-ENTROPY. They provide measurement for brain monitoring and relaxation. They are compatible with all CARESCAPE modular monitors.

Specialty E-module parameters

Parameter	E-NMT	E-EEG	E-ENTROPY	E-BIS
Level of relaxation	X	-	-	-
Nerve stimulation	X	-	-	-
EEG	-	X	-	-
AEP	-	X	-	-

Parameter	E-NMT	E-EEG	E-ENTROPY	E-BIS
Entropy	-	-	X	-
BIS	-	-	-	X

Barcode reader



The barcode reader can be used to scan a Technician ID and Patient Information from barcodes when admitting patients.

The barcode reader comes pre-configured and its configuration must not be changed. If you change the barcode reader it will not operate properly with the monitor.

Keyboard

WARNING

Use only washable keyboard with at least IPX1 protection against ingress of water.



A washable, antibacterial keyboard is specified for use with the monitor. It may be connected to the monitor or display via one of the USB connectors. The keyboard allows you to enter data without using the on-screen keyboard or a touchscreen display.

Mouse



A standard mouse may be connected to the monitor or display via one of the USB connectors. The mouse allows you to select any on-screen items without a Trim Knob control or a touchscreen display.

Remote control and keypad



Keypad with the B850 only.



The remote control and keypad provide all patient monitor controls on a portable component with a Trim Knob control. The remote control is connected to the patient monitor via one of the USB connectors.

Recorders and laser printers



PRN 50-M with the B850 only.

The monitor can print to a configured network laser printer, a PRN 50-M recorder (B850), an optional recorder (B650), or a remote recorder in the network.

You need the IX Network or the S/5 Network for the network printer.

About the Unity Network Interface Device (ID)



The monitor can interface with peripheral medical devices, such as ventilators and gas delivery systems, to centralize patient data on one device. A Unity Network Interface Device (UID) is used with the monitor to communicate with peripheral devices. It acquires digital data from eight individually isolated serial ports. The data is collected from up to eight peripheral devices (not necessarily manufactured by GE), and then the interface device transmits the formatted data to the monitor.

The monitor can only display information that the peripheral device sends. The parameters sent vary with each peripheral device and are subject to change. It is also important to note that alarms vary according to the primary interfaced device.

In some cases, the peripheral device may impose alarm control parameters that you may *not* be able to change or silence with the monitor's controls.

CIC Pro Clinical Information Center



The MC Network establishes communication and allows patient data to be sent to an optional CIC Pro Clinical Information Center (central station). See the CIC Pro Clinical Information Center Operator's Manual for operating instructions.

iCentral



The S/5 Network (Ethernet) establishes communication and allows patient data to be sent to an optional iCentral (central station). See the iCentral and iCentral Client User's Reference Manual for operating instructions.

Remote alarm box (nurse call)

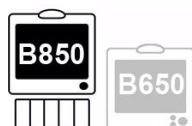

B850 only.



The remote alarm box provides alarm notification at a location remote from the monitor. The remote alarm box interfaces to the monitor via an M-port. All high and medium alarms are sent to the remote alarm box.

iPanel software application

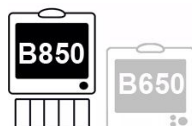









B850 only.









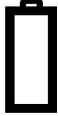

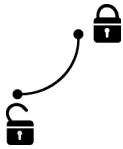
The iPanel application, viewable from one of the monitor's display screens, gives access to desktops created by the hospital IT. These desktops provide patient information from other systems that may be installed at the hospital [e.g., Centricity Clinical Information View (Centricity CIV), MUSE Web, and Picture Archiving Communications System (PACS)]. Desktops can be created with customer defined resolutions using the hospital-wide login and identification process. The iPanel





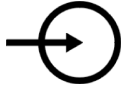



application is used through a Citrix thin client on the monitor so no additional equipment is required at the bedside.

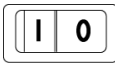
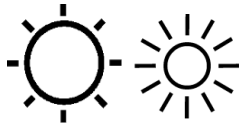
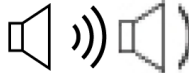

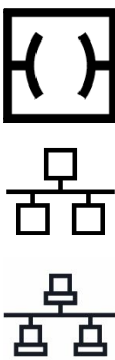

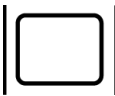

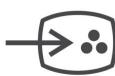

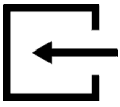

See the supplemental information manual for the iPanel application default settings. See the CARESCAPE Monitor B850 Technical Manual for configuring the size, location, and behavior of the iPanel application.









Equipment symbols









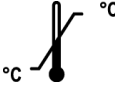

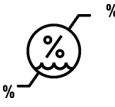
The following symbols appear on one or more of the devices.	
	Bell cancel. Audio off.
	Audio pause. Temporary audio off.
	General alarm.
	Fuse. Replace with identical type and rating fuse.
	Do not reuse.
	Battery (monitor): The flashing orange symbol indicates that there is a battery failure/missing battery.
	Battery (monitor): The solid orange symbol indicates that the battery is being charged.
	Battery (monitor). The solid green symbol indicates that the monitor is being used on battery power.
	Battery (monitor). Located on the battery slot cover.







The following symbols appear on one or more of the devices.	
	Battery (monitor): The battery slot cover is open/closed.
	Battery (monitor): Test button on the battery to check the battery charge level.
	Battery (PDM).
	Communication.
	Power indicator.
	On/standby button.
	Standby or power indicator.
	Signal/power input.
	Signal/power output.
	Signal/power input/output (combined).
	ON. Power connection to the mains.
	Power supply connector.







The following symbols appear on one or more of the devices.	
	Power switch.
	Display brightness controls.
	Display speaker volume controls.
	USB connectors.
	Ethernet connectors.
	Serial interface.
	Tram-Net and ePort connector for PDM module, E-module frame, Tram-Rac housing, and TRAM modules.
	DVI connector. Video output connector for digital or analog source.
	Color display connector.
	Color video input. Video input connector for digital or analog source.
	Color video output. Video output for analog source.
	Color video output, digital. Video output for digital source.

The following symbols appear on one or more of the devices.	
	Gas inlet.
	Gas outlet.
	Press to open.
	Zero all.
IPX1	Degree of ingress protection. Degree of protection against harmful ingress of water: Components not marked with and IPX n code are rated as Ordinary (no protection against fluid ingress). All other IPXn rated components have the degree of protection per the 'n' rating.
	Latex-free.
	D-lite/Pedi-lite: Add date.
	Home. Return to the main display.
	Alternating current. Green symbol on the B650 monitor front panel: the monitor is being used on mains power.
	Direct current.
	Equipotentiality. Connect device to a potential equalization conductor.
	Protective earth ground. Connectors grounded to the AC power source.





The following symbols appear on one or more of the devices.	
	Defibrillator synchronization connectors.
	(WLAN) Class 2 Identifier.
	Stacking limit by number.
	Date of manufacture. This symbol indicates the date of manufacture of this device. The first four digits identify the year and the last two digits identify the month.
	Manufacturer name and address.
	Batch or lot number.
<p>lbl p/n</p>	Abbreviation for label part number.
	Catalogue or orderable part number.
	Device serial number.
	Atmospheric pressure limitations.
	Temperature limitations.











The following symbols appear on one or more of the devices.	
	Humidity limitations.
	Keep dry. Protect from rain.
	Fragile. Handle with care.
	This way up.
	This symbol indicates that the waste of electrical and electronic equipment must not be disposed as unsorted municipal waste and must be collected separately. Please contact an authorized representative of the manufacturer for information concerning the decommissioning of your equipment.
	Recycled materials or may be recycled.
	Recyclable Lithium-Ion.
	Mercury. This product consists of devices that may contain mercury, which must be recycled or disposed of in accordance with local, state, or country laws. (Within this system, the backlight lamps in the monitor display contain mercury.)
	European authorized representative.
	European Union Declaration of Conformity.
	Indicates that the product is certified for both the U.S. and Canadian markets, to the applicable U.S. and Canadian standards.









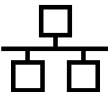

The following symbols appear on one or more of the devices.	
	FCC. USA only. Complies with applicable US government (Federal Communications Commission) radio-frequency interference regulations.
Rx ONLY U.S.	Prescriptive Device. USA only. For sale by or on the order of a Physician.
	Russia only. GOST-R mark.
	Brazil only. INMETRO certificate.
 	<p>The following symbols (required by China law only) are representative of what you may see on your equipment.</p> <p>The number in the symbol indicates the EFUP period in years, as explained below. Check the symbol on your equipment for its EFUP period.</p> <p>This symbol indicates the product contains hazardous materials in excess of the limits established by the Chinese standard SJ/T11363-2006 Requirements for Concentration Limits for Certain Hazardous Substances in Electronic Information Products. The number in the symbol is the Environment-friendly User Period (EFUP), which indicates the period during which the toxic or hazardous substances or elements contained in electronic information products will not leak or mutate under normal operating conditions so that the use of such electronic information products will not result in any severe environmental pollution, any bodily injury or damage to any assets. The unit of the period is "Year".</p> <p>In order to maintain the declared EFUP, the product shall be operated normally according to the instructions and environmental conditions as defined in the product manual, and periodic maintenance schedules specified in Product Maintenance Procedures shall be followed strictly.</p> <p>Consumables or certain parts may have their own label with an EFUP value less than the product. Periodic replacement of those consumables or parts to maintain the declared EFUP shall be done in accordance with the Product Maintenance Procedures. This product must not be disposed of as unsorted municipal waste, and must be collected separately and handled properly after decommissioning.</p> <p>This symbol indicates that this electronic information product does not contain any toxic or hazardous substance or elements above the maximum concentration value established by the Chinese standard SJ/T11363-2006, and can be recycled after being discarded, and should not be casually discarded.</p>
	Underwriters Laboratories product certification mark.

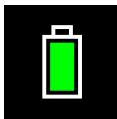

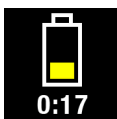
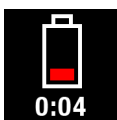







The following symbols appear on one or more of the devices.	
	Canada only. Industry Canada certification number indicates that this product meets the applicable Industry Canada technical specifications.
	China only. China Ministry of Industry and Information Technology identification number for Radio Transmission Equipment Type Approval.
	Australia only. The product complies with the applicable Australian standard and establishes a traceable link between the equipment and the manufacturer, importer or their agent responsible for compliance.
	Japan only. Approved under Japan TELEC requirements.
	Brazil only. Approved under ANATEL (Agência Nacional de Telecomunicações) requirements.
	South Africa only. Approved under ICASA (Independent Communications Authority of South Africa) requirements.
	Korea only. Approved under KCC (Korea Communications Commission) requirements.

User interface symbols

The following symbols appear in the software user interface.	
	Alarm off indicator - Displays in the upper right corner of the parameter window and in the Alarms Setup menu when physiological alarms for this parameter are turned off. The symbol may not display at the central station or on a remote bedside monitor.
	Alarm priority indicator: High (red). Indicates a high priority alarm.
	Alarm priority indicator: Medium (yellow). Indicates a medium priority alarm.
	Alarm priority indicator: Low (cyan). Indicates a low priority alarm.

The following symbols appear in the software user interface.	
	Alarm volume icon. Adjust the minimum alarm tone volume.
	Audio alarms off indicator - Displays in the upper left corner of the alarm area when physiological audible alarms are turned off.
	Audio alarms paused indicator with countdown timer - Indicates all audio alarms are paused and the amount of time remaining for the alarm pause period displays as a countdown timer. Displays in the upper left corner of the screen.
	Pause audio alarms - Selectable from the monitor's main menu. Also an indicator of a temporarily paused active audio alarm
	Low priority audio off alarm indicator. Displays in the upper left corner of the alarm area.
	Configuration warning. Displays when the priority setting for HR/PR high/low , or SpO2 low has been set to low. Check the alarm configuration. Displays in the upper left corner of the alarm area.
	General warning sign. Displays when the priority setting for HR/PR high/low , or SpO2 low has been set to low. Displays in the lower part of the parameter menus' Alarms tab, and in the Priority column of the selected alarm in the Alarm Setup > Alarm Priorities .
	Reminder volume icon. Adjust the volume of the tone that sounds every two minutes when audio alarms are turned off.
	Touch volume icon. Adjust the volume of the tone that sounds when a user touches a touchscreen display.
	Home icon. Close all menus/applications displayed on the monitor.
	Locking setting indicator. Indicates this setting is locked and cannot be adjusted.
	Network connection indicator. Indicates the monitor is connected to the Local Area Network (LAN).

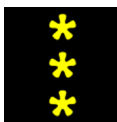
The following symbols appear in the software user interface.	
	Network connection indicator. Indicates the monitor is connected to the Wireless Local Area Network (WLAN).
	Network (WLAN) signal strength. The number of segments corresponds to the signal strength: four segments indicate strong signal, one segment weak signal.
	Monitor battery is full.
	Monitor battery (green). The higher the charge, the bigger the green bar within the symbol. Numbers indicate the remaining run time.
	Monitor battery (yellow). This symbol and a message indicating low battery charge appear when there is less than 20 minutes of run time left.
	Monitor battery (red). This symbol and a message indicating empty battery appear when there is less than 5 minutes of run time left.
	Monitor battery is charging. There is a white running bar inside the symbol.
	Monitor battery failure indicator. Indicates a missing battery or a battery failure.
	PDM battery charging indicator. Indicates the battery is charging.
	PDM battery gauge indicator. Indicates the charge level of the battery.
	PDM battery failure indicator. Indicates the battery is not available for use.

The following symbols appear in the software user interface.	
	Snapshot indicator. Indicates the event has an associated snapshot.
	Beat volume icon. Adjust the volume of the QRS beep tone. Also the beat source indicator. Displays next to the selected beat source.
	Respiration indicator. Indicates a breath is detected by the impedance respiration algorithm.
	BIS and Entropy sensor impedance check indicator (gray). Displays for each sensor as the impedance check is in progress.
	BIS and Entropy sensor impedance check error indicator (red). Indicates the specified sensor failed the impedance check.
	BIS and Entropy sensor impedance check passed indicator. Indicates the specified sensor passed the impedance check.
	Completed NIBP volume icon. Adjust the volume of the tone that sounds when an NIBP measurement result is available.
	Manual NIBP icon. Start a manual NIBP measurement.
	Nellcor OxiMax SatSeconds indicator. Indicates the amount of time the SpO ₂ saturation is outside the limits before alarms are generated.
	SpO ₂ signal strength indicator. Indicates the signal strength, with three asterisks indicating the strongest signal.
	NMT Stimulus beep volume icon. Adjust the volume of the tone that sounds when a stimulus pulse is generated.
	Progress bar. Indicates the amount of time remaining until the next automatic measurement.

4

Monitoring basics

Module compatibility limitations



TRAM and Tram-Rac modules with the B850 only.



CAPNOSTAT Mainstream, CapnoFlex LF and Dual CO2 modules with the B850 only.

For detailed information regarding module, monitor, and accessory compatibility, see the supplemental information manual.

Identical modules

WARNING

Do not use identical measurement modules or modules that map a measurement to the same channel or parameter window. If such modules have been connected, remove the module that has been most recently connected. You can also remove both modules and reconnect the new module after five seconds.

The following modules are considered identical and should not be used simultaneously in the same monitoring system.

To monitor:	Select one of these modules:
ECG, NIBP, SpO ₂ , Temp, IP, Resp	E-PSM, E-PSMP, PDM
C.O., IP, SvO ₂	E-COP, E-COPsv, PDM
CO ₂ , O ₂ , N ₂ O, Patient Spirometry, anesthetic agents, agent identification, gas exchange	E-sCO, E-sCOV, E-sCAiO, E-sCAiOV, E-CO, E-COV, E-COVX, E-CAiO, E-CAiOV, E-CAiOVX, E-miniC, CAPNOSTAT Mainstream, CapnoFlex LF
IP	E-P, E-PT
Separate SpO ₂ measurement	E-NSATX, E-MASIMO

Also note the following limitations:

- TRAM modules 451, 451M, 451N5, 851, 851M, or 851N5: Use only one of each in the same monitoring system.

Connecting and removing modules: B850

WARNING

When connecting PDM or TRAM, the loaded IP labels may affect the channel labeling of other already connected channels, and consequently also the alarm limits.

Connecting a PDM or PSM to a frame

1. Connect the module by aligning it with the insertion guides of the docking station on the outside of the frame.
2. Push the module into the docking station until it clicks and stops.



NOTE

The PDM module requires additional time to power up when used without the PDM battery. Do not interrupt the startup sequence by unplugging the PDM module.

Removing a PDM or PSM from a frame

1. Pull the pull tab out and slide the module out of the guides.
2. Hold onto the module to make sure it does not drop when it comes out.

Connecting other E-modules than the PSM to a frame

NOTE

An E-module can occupy any slot in the frame, no specific order is required.

1. With the module properly oriented (module release latch facing down), align the insertion guide slot in the module with the insertion guide in the frame.
2. Push the module into the frame until it clicks.



Removing other E-modules than PSM from a frame

1. Press the release latch at the bottom of the module.
2. While pressing the release latch, grasp the module firmly and pull out.

Connecting TRAM modules to a Tram-Rac housing

NOTE

A TRAM module must always occupy the top position in the Tram-Rac housing. Other modules are installed below it.

1. Face the Tram-Rac housing and guide the back of the module into the appropriate position.
2. Gently push the module into the housing. You will hear a click when the module is fully inserted.

Removing TRAM modules from a Tram-Rac housing

1. Push the module into the Tram-Rac housing. This releases the module and makes it easier to remove.
2. Press and hold the release levers found on each side of the front of the module.
3. Pull the module out about 15 cm (6 in).
4. Grasp the module firmly with both hands and remove it. Do not try to hold the module by the release levers.

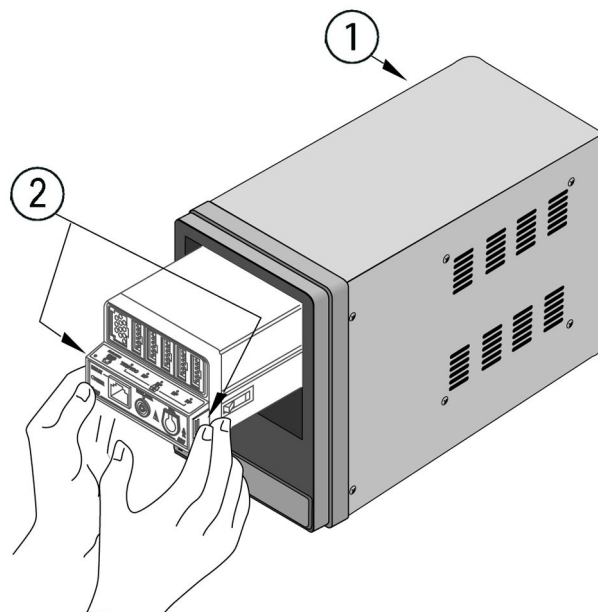

1. Tram-Rac housing
2. Release levers

Connecting and removing modules: B650

WARNING

When connecting PDM, the loaded IP labels may affect the channel labeling of other already connected channels, and consequently also the alarm limits.

Connecting a PDM or PSM to the B650

1. Connect a module by aligning it with the insertion guides on the pivoting module frame.
2. Push the module into the module frame until it clicks and stops.



NOTE

The PDM module requires additional time to power up when used without the PDM battery. Do not interrupt the startup sequence by unplugging the PDM module.

Removing a PSM or PDM from the B650

1. Pull the release tab out and slide the module out of the guides.
2. Hold onto the module to make sure it does not drop when it comes out.

Connecting other E-modules than PSM to the B650

1. With the module properly oriented (module release latch facing down), align the insertion guide slot in the module with the insertion guide in the module frame.
2. Push the module into the module frame until it clicks.



Removing other E-modules than PSM from the B650



1. Press the release latch at the bottom of the module.
2. While pressing the release latch, grasp the module firmly and pull out.

Main keys

Various functions of the monitor can be accessed through the monitor's main menu keys. In addition, they can be accessed through:

- Remote control: optional for both monitors
- M-port keypad: optional for B850
- Trim Knob control: located on the remote control, used for selecting menus and menu options.

The following table lists these keys and where they can be found.

Key	Function	Available through
	Home. Close all menus/applications displayed on the monitor.	<ul style="list-style-type: none"> • Main menu • USB remote control • M-port keypad • GE displays and monitor's built-in display
	Pause audio alarm. Pause active audio alarms or pre-pause audio for incoming active alarms.	<ul style="list-style-type: none"> • Main menu • USB remote control • M-port keypad • GE displays and monitor's built-in display
Alarm Setup	Review: <ul style="list-style-type: none"> • Alarm limits • Alarm priorities • Arrhythmia alarm settings • Audible and visual alarm indicators 	<ul style="list-style-type: none"> • Main menu • USB remote control • M-port keypad

Key	Function	Available through
Monitor Setup	<ul style="list-style-type: none"> • Screen setup <ul style="list-style-type: none"> ▪ Also primary / secondary screen with B850 • Printing setup • Parameter setup • Parameter colors • Sound volumes • PDM battery status • Monitor battery status (B650) • Brightness settings (B650) • Invasive pressure calibration • Password protected functions: default setup, service calibrations, service 	<ul style="list-style-type: none"> • Main menu • USB remote control • M-port keypad
Procedures	<ul style="list-style-type: none"> • Cardiac output • Catheter insertion • Wedge • 12 lead analysis • ST trends • Patient Spirometry loops • Timers: <ul style="list-style-type: none"> ▪ Elapsed time ▪ Countdown timer 	<ul style="list-style-type: none"> • Main menu • USB remote control • M-port keypad
Data & Pages	<ul style="list-style-type: none"> • Admit/discharge patient (ICU, ED, NICU software packages) • Start/end case (OR, PACU software packages) • Drug calculator • Laboratory data • Calculations for hemodynamic, oxygenation, and ventilation measurement values • Other patients in the network • B850: iPanel • Select predefined pages on screen 	<ul style="list-style-type: none"> • Main menu • USB remote control • M-port keypad

Key	Function	Available through
Trends	<ul style="list-style-type: none"> Graphic, Numeric, Snapshot, ST-snapshot, and Machine Gas Cons. trends Event data Trend scales 	<ul style="list-style-type: none"> Main menu USB remote control M-port keypad
Print Waveforms or Stop Printing	Print or stop printing the parameter waveforms.	<ul style="list-style-type: none"> Main menu USB remote control M-port keypad
Freeze/Snapshot or Unfreeze	<p>Freeze or unfreeze the scrolling waveforms. Freezing will automatically end after 15 seconds, or you can end it manually.</p> <p>A snapshot is taken every time this button is pressed.</p>	<ul style="list-style-type: none"> Main menu USB remote control M-port keypad
NIBP Auto Start or NIBP Auto Stop	Start or stop automatic non-invasive blood pressure measurements at timed intervals. After selection, the button toggles to NIBP Auto Stop .	<ul style="list-style-type: none"> Main menu
NIBP Start or NIBP Cancel	Start or stop a non-invasive blood pressure measurement. After selection, the key toggles to NIBP Cancel .	<ul style="list-style-type: none"> Main menu
NIBP Auto	Start or stop automatic non-invasive blood pressure measurements at timed intervals.	<ul style="list-style-type: none"> USB remote control M-port keypad
NIBP Start/Stop	Start or stop a non-invasive blood pressure measurement.	<ul style="list-style-type: none"> USB remote control M-port keypad
Parameters	Select and review parameter settings.	<ul style="list-style-type: none"> USB remote control M-port keypad
Zero All Pressures	Zero all invasive pressure channels. This does not apply to ICP.	<ul style="list-style-type: none"> Main menu USB remote control M-port keypad

Main screen layout

The main screen displays alarms, information, trends, snapshots, waveforms, parameter windows, and the main menu in pre-defined areas.

When the information area of the screen is selected, it opens the **Admit/Discharge** menu and provides access to the **Patient, Load Patient, Administr. Information** and **Standby** tabs. If the OR or PACU software packages are used, the **Case Setup** menu opens and the **Standby** tab is not available.

Alarm area		Information area
Split screen area (option). You may also select Minitrend as an option for this area.	Waveform area	Upper parameter windows
Lower parameter windows (option)		
Main menu area		

In addition, the information area of the screen displays the following information:

- Patient name (if entered).
- Profile name that is being used for patient monitoring.
- PDM battery gauge icon if a PDM module is connected to the monitor. You can access the **Battery Status** menu by clicking this icon.
- B650: Monitor battery gauge and battery status icons (if battery is inserted). You can access the **Battery Status** menu by clicking these icons.
- Bed name and care unit of the local monitor (if connected to the MC Network).
- Network symbol (if connected to the MC Network or S/5 Network).
- B650: WLAN signal strength symbol (if connected to the wireless network).
- Telemetry transmitter used in combination monitoring
- Current time of day.

An example of a menu

The following is an example of a menu illustrating some of the components and how they are referred to in this manual:

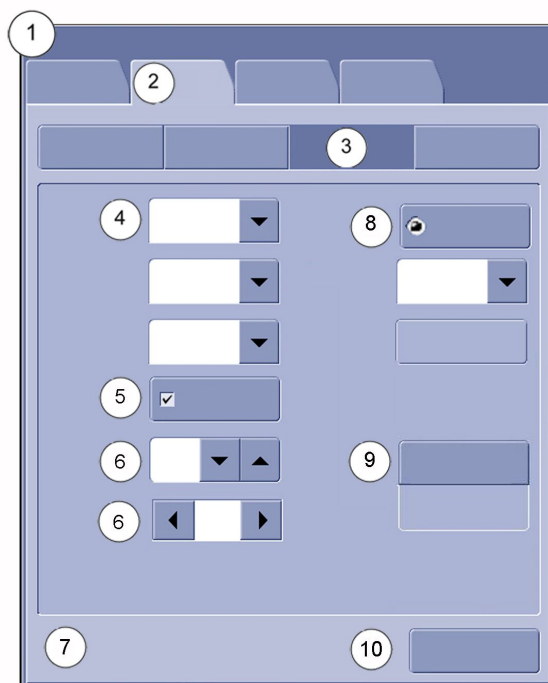

1. Menu title (for example, **ECG**)
2. Submenu tabs (for example, **ECG, ST, QT, Arrhythmia**)
3. Tabs (for example, **Setup, Alarms**)
4. Selection lists: when selecting the arrow, a list of options appears
5. Check box for selecting/deselecting a feature
6. Arrow selector spinner for increasing/decreasing a value
7. Help text area
8. Radio button for selecting/deselecting a feature
9. Selection key. The field below shows the current selection/status.
10. Exit key (for example, **Previous Menu, Close**)

NOTE Not all menus have these same components.

Menu options

In this manual, the term select means using the mouse, Trim Knob control, or touchscreen display to select an item on the screen.

Selecting menu options with a touchscreen

NOTE Do not use pencils, pens, or other sharp objects to activate the touchscreen. The touchscreen will not function properly if tape or paper is stuck to the display surface.

1. Touch the menu option with your finger.
2. The highlight on screen moves to this option.

3. Lift your finger off the screen, and the selected function is performed (e.g., a list opens).

Selecting menu options with the Trim Knob control

1. Rotate the Trim Knob control in either direction to move the highlighted cursor from option to option on the display.
2. Press the Trim Knob control once to select the highlighted option.

Selecting menu options with a mouse

1. Move the mouse until the pointer (arrow) is on the menu option you wish to select.
2. Click the left mouse button once.

Data field entries

You can use the on-screen keyboard or a standard keyboard to type data into a data field. Data fields are selected with a touchscreen, Trim Knob, or mouse.

Entering data with the on-screen keyboard

When data entry is required, the monitor automatically displays an on-screen keyboard for you to use.

1. Select the desired field.
The selected field changes color into yellow, indicating that you can begin entering the text.
2. Select the characters you wish to type with the mouse, Trim Knob, or touchscreen.

Entering data with a keyboard

1. Select the desired data field.
The selected field changes color into yellow, indicating that you can begin entering the text.
2. Type the desired text into the selected field with the keyboard.

Putting the monitor into operation

Operation warnings

- WARNING** After transferring or reinstalling the monitor, always check that it is properly connected and all parts are securely attached.
- WARNING** When detaching modules, be careful not to drop them. Always support with one hand while pulling out with the other.
- WARNING** — ACCURACY — If the accuracy of any value displayed on the monitor, central station, or printed on a graph strip is questionable, determine the patient's vital signs by alternative means. Verify that all equipment is working correctly.

- WARNING** If you accidentally drop the monitor, modules, Frames, or Tram-Rac, have them checked by authorized service personnel prior to clinical use.
- WARNING** To prevent liquids from entering the display casing, do not tilt the display or monitor more than ± 15 degrees.
- WARNING** B850 only: Do not use the monitor without manufacturer approved mounting attached.

Operation caution

- CAUTION** The device/system should not be used adjacent to, or stacked with, other equipment. Consult qualified personnel regarding device/system configuration.

Monitor installation points to note

- To avoid electrostatic charges building up, it is recommended to store, maintain and use the equipment at a relative humidity of 30% or greater. Floors should be covered by ESD dissipative carpets or similar ESC dissipative products. Non-synthetic clothing should be used when working with the component.
- Choose a location that affords an unobstructed view of the display and easy access to the operating controls at the monitor or remotely via View on Alarm or remote devices like central stations.
- Set up the monitor in a location that affords sufficient ventilation. The ventilation openings of the device must not be obstructed (by equipment, walls, or blankets, for example).
- The environmental operating conditions specified in the technical specifications must be ensured at all times.
- The monitor is designed to comply with the requirements of IEC 60601-1.
- Using the power cord supplied with the monitor, connect it to the power line. Use only the original cord.
- For measurements in or near the heart, we recommend connecting the monitor to the potential equalization system. Use the green and yellow potential equalization cable and connect it to the pin labeled with the equipotential symbol: 
- B850: The operating position of the processing unit does not influence the performance of the monitor in any way.
- B850: To prevent any liquid from entering the modules, make sure that the Frame is mounted horizontally so that the modules will be in a vertical position.

- CAUTION** — PACKAGING DISPOSAL — Dispose of the packaging material, observing the applicable waste control regulations.

Turning on the monitor

The monitor is preset at the factory for a specific AC voltage. Before applying power, be sure that the power requirements match your power supply. Refer to the label on the back of the processing unit (B850) or on the monitor back panel (B650) for voltage and current requirements.

1. Ensure all cables are properly connected.
2. Turn on the power:
 - a. B850: Press the power on/off switch located on the back of the processing unit to the I (on) position, and turn on the power to the display screen.
 - b. B650: Press the on/standby button located on the monitor front panel.

The welcoming screen will appear with a status bar indicating the progress of the startup procedure.

Performance check

After turning on the monitor, and during operation, the monitor runs automatic self-tests. If a malfunction is detected, the monitor displays a message or an alarm, depending on the severity of the malfunction.

Message about PDM service

After connecting the PDM module, and during operation, the PDM module runs automatic self-tests. If a malfunction is detected, the monitor displays the **Service the PDM** message. If this message displays, do not use the module and contact your authorized service personnel.

Pre-monitoring checklist

Before you start monitoring a patient check the following:

- Acquisition modules are firmly in place.
- Accessories are intact and properly connected.
- Monitor is displaying the monitoring screen.
- No messages display indicating the monitor or acquisition module is not functioning.
- Desired parameters are selected to view on the screen.
- Alarm signals are working and can be seen and heard in your care environment.
- Required parameter calibrations are completed.

Supply mains interruption

If the supply mains to the equipment is interrupted for less than 15 minutes (and the B650 is used without the optional battery), the monitor keeps the trend data and the latest user-made settings. If not, contact authorized service personnel. After 15 minutes, all patient information and trend data is lost and the monitor returns to the user default settings (start-up mode). For more information, see the technical manual.

Power failure alarm

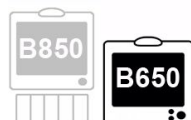

B650 only.

If there is a power failure (e.g., the supply mains is interrupted and the monitor battery fails), the monitor gives a continuous beeping alarm. This alarm remains active for as long as there is some residual power left, or until it is silenced with the pause audio alarm key, or until the power is reconnected.

5

Setting up the monitor before use

Normal screen and other pages

When monitoring begins, the main page appears automatically. This preconfigured page is called the normal screen. Any changes you make to the screen setup during monitoring are changes to this normal screen. These changes are not permanent unless they are saved to a profile. They are valid until the case is reset/the patient is discharged from the monitor. They are also kept in the monitor memory for 15 minutes after the power is turned off.

Pages are user-defined screen formats. The contents are preconfigured but can be changed. Page configuration is password protected, but once the pages are configured they can be selected to screen by all users. There may be pages designed, for instance, for physicians, surgeons, or nurses. For more information on page configuration, see the supplemental information manual.

In addition to the normal screen, each profile can have up to five additional pages and some of these may be preconfigured. These additional pages are needed for instance when all the measured parameters do not fit on the normal screen page. These pages can also include information that is needed only during a specific phase of care. The name of the page currently in use is always displayed in the upper part of the screen.

Selecting the normal screen (main page)

You can return to the normal screen (main page) any time during the monitoring.

You can either select the  icon or key, or:

1. Select **Data & Pages**.
2. Select **Normal Screen**.

Selecting pages

You can select different pages to the screen during monitoring to view their information.

1. Select **Data & Pages**.
2. Select the radio button of the page you want to see.
3. You can return to the normal screen by selecting the home icon or home key, or through **Data & Pages > Normal Screen**.

Adjusting sound volumes

You can adjust various sound volumes according to your care environment needs. While you are adjusting the volume, you will hear a corresponding sound that will guide you in determining a suitable level. All volumes other than **Alarm Volume** can be set to 0 if required.

1. Select **Monitor Setup**.
2. Select **Sound Volumes**.
3. Adjust the different sound volumes:
 - **Beat Volume**
 - **Completed NIBP Volume**
 - **Stimulus Beep Volume**
 - **Alarm Volume**
 - **Touch Volume**. This selection is not adjustable if it has been locked in the **Care Unit Settings**.

Brightness settings

B850 display brightness

For information on how to set the display brightness for B850 displays, refer to their user manual.

Adjusting the display brightness automatically



B650 only.

With the automatic adjustment, the display brightness is automatically set according to the ambient light. This same setting also turns on the keyboard light automatically.

1. Select **Monitor Setup > Brightness**.
2. Select the radio button for **Automatic** adjustment.

Adjusting the display brightness manually

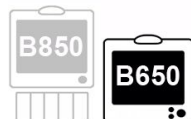

B650 only.

With the manual adjustment, you can set the display brightness level according to your needs.

1. Select **Monitor Setup > Brightness**.
2. Select the radio button for **Manual** adjustment.
3. Select **Display %** and adjust the display brightness in the range of 30% to 100%.

Adjusting the alarm light brightness

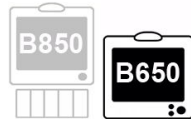

B650 only.

1. Select **Monitor Setup > Brightness**.
2. Select the radio button for **Manual** adjustment.
3. Select **Alarm Light %** and adjust the brightness.

NOTE

You can also adjust the alarm light brightness through **Alarm Setup > Audible & Visual > Alarm Light %**. This selection is available for the B850 also.

Setting the keyboard light to turn on automatically

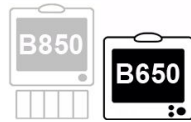

B650 only.

With the automatic adjustment, the keyboard light comes on automatically when the brightness level of the display stays below or above set default limits for more than 10 seconds. This same selection adjusts the display brightness level automatically.

1. Select **Monitor Setup > Brightness**.
2. Select the radio button for **Automatic** adjustment.

Turning the keyboard light on manually

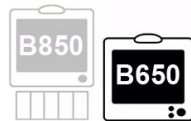

B650 only.

You can select the keyboard light on or off manually when needed.

1. Select **Monitor Setup > Brightness**.
2. Select the radio button for **Manual** adjustment.
3. Select **Keyboard** and set the keyboard light **On** or **Off**.

Screen setup modifications

Parameter windows

The parameter windows show numeric or graphic presentation of the measurement data. Each window can contain one or several parameters according to what you have chosen.

The parameter windows can be of four different sizes according to the number of selected and active parameters on screen. The sizes can be described as big (full

width, full height), small (half width, half height), tall (half width, full height), and wide (full width, half height):

BIG	SMALL	TALL	WIDE

You can configure parameters to the lower parameter area (horizontal, lower part of the screen) and/or to the upper parameter area (vertical, on the right).

Upper parameter area

You can configure individual waveforms and parameter windows in the **Upper Parameter Area**. One parameter window can show more than one parameter when parameter combinations (such as **SpO2 & SvO2**) are used.

You can also combine invasive pressure waveforms. ECG or ST monitoring reduces the number of upper parameter windows by one, and monitoring both of them reduces the number by two.

Lower parameter area

Any numeric parameter window in the lower parameter area having an empty field (=OFF) above or below it is automatically enlarged.

You can configure a maximum of eight lower parameter windows. When the lower parameter windows are on, they reduce the space used for waveforms and upper parameter windows: you can then choose up to six waveforms and 12 parameter windows to display in the upper parameter area of the screen.

Selecting parameters to the screen

Most parameters appear on screen automatically when their measurement starts. However, if you cannot see the parameter you are measuring, select it to the screen:

1. Select **Monitor Setup > Screen Setup**.
2. B850 with the Double Video license: Select **Screen 1** or **Screen 2** tab.
3. Select the parameter to the upper or lower parameter area:

- a. Select **Upper Parameter Area > Show Parameter**.

If a parameter is still not visible in the upper parameter area after you have selected it to the screen, raise its priority with the arrow keys in the **Change Order** column. If you want to hide the waveform of a parameter, deselect **Show with Waveform**.

- b. Select **Lower Parameter Area** and activate it by selecting the radio button **Double Height** or **Single Height**. Then select the parameter from the dropdown lists. To hide the **Lower Parameter Area** from the screen, select **Off**.

Selecting **Double Height** allows eight different parameter combinations in the selection lists in addition to the individual parameters, and selecting **Single Height** allows four combinations.

Waveform field safety precautions

WARNING

Always make sure that the waveform size is sufficient for the care environment.

CAUTION

The waveform autoscaling feature automatically updates the display from the best possible signal amplitude. Always make sure that the waveform display scale is correctly understood and does not lead to delayed patient treatment.

Selecting the display mode for IP waveforms

You can select the invasive pressure waveforms to be shown as individual waveforms, or in a combined view.

1. Select **Monitor Setup > Screen Setup**.
2. B850 with the Double Video license: Select **Screen 1** or **Screen 2** tab.
3. Select **Upper Parameter Area**.
4. Select an option from the **Invasive Pressure Waveforms** list:
 - To view individual waveforms, select **Individual**.
 - To combine the currently displayed adjacent waveforms (2 to 4), select **Combined**. The new waveform field will use the combined height of the original fields.
 - To combine up to four waveforms in one field, select **4invP**. The new waveform field will use the height of two upper parameter windows.

Setting up a split screen

You can split the waveform area into two parts. The split screen option divides the screen so that you can view graphic and/or numeric data of the chosen measurement on the left while still having waveforms and parameter windows visible at the same time.

1. Select **Monitor Setup > Screen Setup**.
2. B850 with the Double Video license: Select **Screen 1** or **Screen 2** tab.
3. Select **Split Screen**.
4. Select the type of split screen you need from the dropdown list:
 - **Off**: no split screen
 - **ST** shows current and reference QRS complexes and ST trends.
 - **Spiro 1** is a basic view of Patient Spirometry data.
 - **Spiro 2** is an enhanced view of Patient Spirometry data.
 - **EEG** shows the EEG compressed spectral array (CSA).
 - **AEP** shows the current auditory evoked potentials (AEP) waveforms.
 - **Minitrend** shows minitrends beside waveforms.

Locked alarm and parameter settings

Some care unit and profile settings can be locked. Clinicians cannot adjust the locked settings for the admitted patient. These settings are indicated with a lock symbol: .

The alarm and parameter settings that can be locked vary by acquisition module. They are set in the **Care Unit Settings** and they are password protected.

For more information, see the supplemental information manual.

Color selections

You can select display colors for the timer and all parameters according to your needs. However, note that these settings are not adjustable if the selection has been locked.

For more information, see the supplemental information manual.

Selecting colors for IP channels without labels

1. Select **Monitor Setup** > **Colors**.
2. Select the **Invasive Pressures** tab.
3. Select **Channels**.
4. Select the colors from the lists.

Selecting colors for IP channels with labels

1. Select **Monitor Setup** > **Colors**.
2. Select the **Invasive Pressures** tab.
3. Select **Labels**.
4. Select the colors from the lists.

Selecting colors for other parameters and timer

1. Select **Monitor Setup** > **Colors**.
2. Select the **Other Parameters** tab.
3. Select:
 - a. **Common** and the colors from the lists.
 - b. **Specific** and the colors from the lists.
 - c. Select the color for the timer through **Specific** > **Timer**.

Parameter configurations

Before monitoring a patient, always check the parameter setup settings and alarm limit values. Parameter settings and alarm limit values can be configured by selecting **Monitor Setup** > **Parameter Setup**, then selecting a parameter. You can also access setup and alarm settings by selecting a parameter window of a parameter that has already been configured to the screen.

Setting up printing options

You can check that the printing options for waveforms, reports and devices are set according to your needs when you start monitoring a patient.

1. Select **Monitor Setup**.
2. Select **Printing**.
3. Check the settings by going through the different options and change if necessary.

Checking the PDM battery status

1. Select the battery status area in the upper right corner of the screen, or select **Monitor Setup** > **Battery Status**.

2. B650 only: Select the **PDM** tab. With the B850 the **PDM** battery status view opens automatically.
3. Check the battery status information.

Checking the monitor battery status

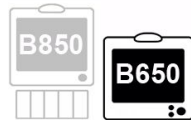

B650 only.

1. Select the battery status area in the upper right corner of the screen, or select **Monitor Setup > Battery Status**.
2. Check the **Monitor** battery status information that appears.
3. If you wish to see more detailed battery information, select the **Advanced** tab.

Setting the touchscreen off

You can set the touchscreen feature off for 30 seconds at a time when you need to clean the screen. The countdown timer appears on the screen.

1. Select **Monitor Setup**.
2. Select **Touchscreen Off**.
3. To enable the touchscreen, press any monitor hardkey or use the Trim Knob, or press **Cancel** in the **Touchscreen Off** display for three seconds.

B850 with several screens

You can define the screen settings for several screens with the B850. For instance, you can select which applications they show, do they show menus and/or alarms etc.

For more information, see the supplemental information manual.

Other setup changes

All other setup changes, like care unit settings and profile settings, require a password.

For more information, see the supplemental information manual.

Setting up the monitor before use

6

Starting and ending monitoring

Monitor and module compatibility

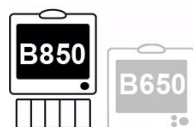

TRAM and Tram-Rac modules with the B850 only.

Software packages and terminology

The terminology used in different software packages varies: in OR and PACU, you start or reset a case, and in other software packages you admit or discharge a patient. In addition, some other menu selections may also differ according to the licenses in use. Read all instructions carefully.

About the user default settings

User default settings mean those settings (start-up mode, profile etc.) that the user has saved into the monitor to replace the factory default settings. The monitor uses these settings when it is turned on and after a power off situation that lasts more than 15 minutes. If there are no user default settings, factory default settings are used.

Invasive pressure labels and PDM or TRAM

WARNING When connecting PDM or TRAM, the loaded IP labels may affect the channel labeling of other already connected channels, and consequently also the alarm limits.

When monitoring is started, stored invasive pressure labels for zeroed channels will be transferred from the PDM or TRAM to the monitor. Labels for those channels that have not been zeroed will be the ones selected at the monitor. Note that the currently stored labels may differ from defaults.

The IP labels saved to PDM or TRAM are mapped according to this table:

From the monitor	to PDM or TRAM
<i>Art</i>	<i>ART</i>
<i>ABP</i>	<i>ART</i>
<i>CVP</i>	<i>CVP</i>

From the monitor	to PDM or TRAM
<i>Fem</i>	<i>FEM</i>
<i>FemV</i>	<i>SP</i>
<i>ICP</i> (intracranial pressure)	<i>ICP</i>
<i>LAP</i>	<i>LA</i>
<i>P1 to P8</i>	<i>SP</i>
<i>PA</i>	<i>PA</i>
<i>RAP</i>	<i>RA</i>
<i>RVP</i>	<i>SP</i>
<i>UAC</i>	<i>UAC</i>
<i>UVC</i>	<i>UVC</i>

The IP labels loaded from PDM or TRAM are mapped according to this table:

From PDM or TRAM	to the monitor
<i>ART</i>	<ul style="list-style-type: none"> • <i>Art</i>: default • <i>ABP</i> if the current site for this channel is <i>ABP</i>, or if some other active channel is already associated to <i>Art</i>.
<i>CVP</i>	<i>CVP</i>
<i>FEM</i>	<i>Fem</i>
<i>ICP</i>	<i>ICP</i>
<i>LA</i>	<i>LAP</i>
<i>SP</i>	<ul style="list-style-type: none"> • <i>FemV</i> if the current site for this channel is <i>FemV</i> • <i>RVP</i> if the current site for this channel is <i>RVP</i> • <i>P1 to P8</i>, depending on the channel
<i>PA</i>	<i>PA</i>
<i>RA</i>	<i>RAP</i>
<i>UAC</i>	<i>UAC</i> if the software package is NICU, otherwise <i>Art</i>
<i>UVC</i>	<i>UVC</i> if the software package is NICU, otherwise <i>CVP</i>

Starting monitoring

A case automatically starts/a patient is admitted when the monitor detects any of the following vital signs: ECG, impedance respiration, Art, ABP, Fem, UAC, NIBP, SpO₂, CO₂, EEG, BIS, or Entropy. Each vital sign has activation criteria that must be met before the vital sign is considered active. When a case is started/a patient is admitted

at the bedside monitor and the monitor is connected to the network, patient data will display at the central station.

A case manually starts/a patient is admitted when any patient data is entered or loaded. Patient data can be entered locally using the monitor, loaded from an Admit-Discharge-Transfer (ADT) server over the CARESCAPE Network, or entered remotely using a central station. If the monitor is connected to the S/5 Network, patient and trend data can be loaded to the monitor from iCentral. No trend data can be loaded from the CARESCAPE Network.

Always observe the monitor and the patient carefully during start-up periods and when inserting acquisition modules.

CAUTION

- Discharge to clear patient data - When admitting a new patient/starting a new case, you must clear all previous patient data from the system. To accomplish this, be sure the acquisition module is securely mounted, disconnect the patient cables, then discharge the previous patient/end the case.

The following are generic instructions listing the basic steps for starting monitoring. Parameter-specific instructions are more detailed and should always be followed as well.

1. Connect the patient to the monitor according to the measurement setup requirements. The alarms and parameter settings become active.
2. If the startup profile is not suitable, select another profile.
3. Enter patient demographics, or load/combine the data.
4. Start the measurement.
5. Zero invasive pressure lines.
6. If required, change the parameters on screen.
7. Check alarm limits and adjust if necessary.

About the combination monitoring mode

The combination monitoring is a licensed feature. In combination monitoring mode ECG is acquired from a telemetry receiver system. This ECG data acquisition capability enhances basic telemetry monitoring by providing access to all of the available parameters from bedside monitors, while acquiring the ECG data from telemetry. In this monitoring mode, all data — local and telemetry — is viewed at the central station and the bedside monitor. However, any historical data stored at the central station will be unavailable. Any new alarm history samples created on the telemetry transmitter cannot be viewed on the monitor if they are created after the combination monitoring has been started. Only the snapshots created on the monitor and the samples of the telemetry transmitter created prior to starting the combination monitoring can be viewed.

The combination monitoring mode can be enabled through **Monitor Setup > Default Setup > Care Unit Settings > Telemetry > Monitor or Telemetry**, and the setting is password protected. The monitor needs to be configured to the CARESCAPE Network. This option cannot be used in the NICU software package.

In case the telemetry patient has been admitted when the device is connected to the monitor, the arrhythmia alarm priorities and limit alarm priorities (except in case the

monitor alarm is set to escalating) and the following ECG settings of the telemetry will be used:

- HR, ST, and PVC alarm limits
- PVC alarm status (on/off)
- Pacemaker detection
- Lead analysis
- Va lead position
- Primary lead
- ECG waveform size
- Arrhythmia detection level
- ST analysis status (on/off)

When combination monitoring is started with a non-admitted telemetry patient, these same settings from the monitor will be sent to telemetry. Additionally, the **Telemetry Waveforms** printing location is sent to telemetry.

If the telemetry alarm priority is such that it is not supported by the monitor, it will be mapped to the next higher priority available.

NOTE Patient's age affects the alarm limits and alarm priorities and also the configuration of the ECG algorithm including arrhythmia alarms in the combination monitoring mode. For more information, see the ApexPro Telemetry System Operator's Manual.

When combination monitoring is started with a non-admitted telemetry patient, the printout type selection will be sent to the telemetry transmitter.

CAUTION Users should be aware that all waveforms may be delayed up to 2 seconds in the combination monitoring mode. If the delay needs to be avoided, the combination monitoring mode should be discontinued and all waveforms should be acquired via the hard-wired bedside monitor.

CAUTION Users should be aware of a possible time discrepancy between the waveforms from the telemetry device and the waveforms from a device hard-wired to the monitor. Users should not consider these waveforms to be synchronous. If absolute synchronicity is desired, the combination monitoring mode should be discontinued and the ECG waveforms should be acquired via the hard-wired bedside monitor.

Entering patient data

Entering patient data with the monitor

1. Select the patient information area on the screen, or select **Data & Pages > Admit/Discharge** or **Start / Reset Case**.
2. Select the **Patient** tab.

3. Edit or enter patient data:
 - a. Select **Edit Name & MRN**, select the field to be edited and enter the data.
 Entering the **Second Id** in addition to the **Medical Record Number** allows a flexible use of local patient identification methods, like the use of BSN in the Netherlands. The **Second Id** has no network support, so only the **Medical Record Number** can be used for searching and retrieving patient data from the network. Both **Medical Record Number** and **Second Id** will appear in the printouts.
 - b. Select **Edit All Demographics** and select values for different types of data.
 If 12SL ECG with ACI-TIPI or 12RL 12 lead ECG is licensed, also the **Ethnicity** selection is available.
 You can edit **Height** and **Weight** also from the lists on the **Patient** tab.
 - c. If the combination monitoring mode **Monitor or Telemetry** has been enabled in the configuration, the **ECG Source** selection is available. You can select the **ECG Source** from a list containing the monitor and available telemetry transmitter(s). When you confirm the source selection with **Confirm**, the connection between the selected transmitter and monitor will be established (telemetry transmitter selected), or the patient is discharged from the telemetry transmitter (monitor selected).

Entering patient data with a barcode reader

You can scan patient data from barcodes if this function has been enabled during configuration. For more information, see the monitor's technical manual.

1. Select the patient information area on the screen, or select **Data & Pages > Admit/Discharge** or **Start / Reset Case**.
2. Select the **Patient** tab.
3. Select **Scan from Barcode**.
 Any information, including empty fields, scanned from the barcodes replaces the corresponding information previously entered from the monitor.
4. You can cancel the scanning by selecting **Cancel Scan**.

About the roving functionality

Roving functionality allows you to move, or rove, the monitor to fit the patient's acuity needs, rather than moving the patient to a monitored room. When you move the monitor to a new location in the CARESCAPE Network, you can update the unit and/or bed names from drop-down lists, or add new names manually. Available selections depend on what has been allowed in configuration.

This functionality is also available in the combination monitoring mode for roving between beds. In other words, you can move the monitor or a patient wearing a telemetry transmitter from one location to another and update the information accordingly.

These settings are configured through **Monitor Setup > Default Setup > Care Unit Settings > Roving** and they are password protected.

Roving between units

If roving between units is allowed, you can update the unit name when moving the monitor to a new location.

1. Select the patient information area on screen.
2. Select the **Care Unit & Bed** tab.
3. Select the **Care Unit Name** from the dropdown list.

Changing the **Care Unit Name** will also update the contents of the **Bed Name** list.

You can also change the name manually through **New Unit & Bed**. This selection is available in the **Care Unit & Bed** menu if it has been allowed in the **Roving** settings.

Entering the Location ID for 12SL

If roving between units is allowed and the 12SL ECG with ACI TIPI is enabled, you can enter the **Location ID** that will be used in the 12SL reports.

1. Select the patient information area on screen.
2. Select the **Care Unit & Bed** tab.
3. Select the **Location ID** field and enter the ID with the on-screen numeric keypad. You can enter any number from 0 to 599.

Roving between beds

If roving between beds is allowed, you can update the bed name when needed.

1. Select the patient information area.
2. Select the **Care Unit & Bed** tab.
3. Select the **Bed Name** from the dropdown list.

The new name appears in the upper right corner of the display. The unit name is given first, then a dash and the bed name (for instance, UNIT1-BED1).

You can also change the name manually through **New Unit & Bed**, or through **New Bed**. These selections are available in the **Care Unit & Bed** menu according to what has been allowed in the **Roving** settings.

Adding new units and beds (manual roving)

If manual roving between beds and/or units is allowed, you can also enter their names manually.

1. Select the patient information area.
2. Select the **Care Unit & Bed** tab.
3. Select **New Unit & Bed**.

If the **Roving** settings do not allow roving between units, the **New Unit & Bed** is not available. In this case, select **New Bed** to enter a new bed name.

4. Select the **Care Unit Name** or the **Bed Name** field and type the new name with the on-screen keyboard.

The maximum number of characters for the **Care Unit Name** is seven, and for the **Bed Name** it is five.

5. Select **Confirm** to ensure that the names you entered are valid.

Entering administrative information

Administrative information can be transferred from the monitor to the PDM only.

1. Select the patient information area on screen.
2. Select the **Administr. Information** tab.
3. Select **Edit**.
4. Select the field to be edited and enter the data as required:
 - **Visit Number**
 - **Primary Physician**
 - **Referring Physician**.

Loading patient information from the CARESCAPE Network (ADT server)

In the CARESCAPE Network, patient information can be loaded from the ADT server. You cannot merge data between the monitor and the ADT server.

1. Select the patient information area on the screen.
2. Select the **Load Patient** tab.
3. Select **Find Patients**.
4. Select the **Medical Record Number** and/or **Last Name** field and enter the information you have available.

You can also add the **First Name** information but the search does not function with this information only.
5. Select **Find**.
6. When the patient list appears, select the patient.
7. Select **Load Patient Information** to load the data from the ADT server.

Loading patient data and trend data from the S/5 Network

1. Select the patient information area on the screen.
2. Select the **Load Patient** tab.
3. Select a central station from the **Central** list.

A patient table appears, showing all the patient cases saved on the selected central station.
4. Select a patient from the table.

5. One of the following selections is available:
 - **Start New** is available when there is no active patient case/admitted patient on the monitor. Select this to load patient data from the network.
 - **Reset Current** or **Discharge Current** is available when there is an active case/admitted patient on the monitor. Select this to end the case/discharge the patient on the monitor and to erase all patient data. The selected patient case is loaded from the network.
 - **Merge to Current** when there is an active patient case/admitted patient on the monitor and the same patient can be found at the central station. Select this to combine their patient data.

The message **Loading from network** is displayed until all data has been loaded. The monitor will send all updated patient data except trends to a connected PDM or TRAM.

About standby

When you remove the patient temporarily from the monitor, you can use the standby option. Standby locations are defined during configuration through **Monitor Setup > Default Setup > Care Unit Settings > Standby Sites**. These settings are password protected.

For more information, see the supplemental information manual.

Starting standby

1. Select the patient information area on the screen.
2. Select the **Standby** tab.
3. Select the radio button for an appropriate standby location.

The factory default locations are the following but they can be changed during configuration:

- **Operating Room**
- **MRI**
- **CT Scan**
- **Physiotherapy**
- **Dialysis**
- **Radiology**

4. Select **Prepare for Standby**.

If patient cables are still connected and the monitor receives vital signs, a text indicating that audio alarms have been paused appears.

5. Disconnect patient cables to start the standby.

If you do not disconnect the cables and vital signs are still present after the audio pause time expires, the standby is canceled.

6. Check that the **NIBP Auto** is turned off.

The screen goes blank and the GE logo with a text like **Patient temporarily in MRI** (location according to your selection) appears.

End of standby

The monitor ends the standby automatically when any of the following conditions occur:

- Vitals signs are still present after **Prepare for Standby** has been selected and the audio pause time expires.
- Any vital signs are detected as active.
- User input is received: a keyboard key is pressed, Trim Knob is pressed or rotated, primary mouse button is pressed, touchscreen is pressed.
- A PDM or TRAM is connected.

About continuing monitoring

Patient information and data is stored in the PDM and TRAM. The **Connecting Measurement** message appears on the monitor when the PDM or TRAM is first connected. Vital sign monitoring is not available during this initialization time. At the conclusion of the initialization, the stored patient information and data can be transferred to the monitor from the acquisition module. While patient information and data is being transferred, the **Loading from PDM** or **Loading from Tram** message appears on the monitor. The type of patient information and data that can be transferred includes the following:

- Patient demographic data
- Patient trends and alarm histories; alarm histories are converted to snapshots during the transfer
- All zeroed invasive pressure site labels
- All invasive pressure transducer zero values for channels 1 to 4
- Latest values and timestamps for C.O., PCWP, and NIBP measurements
- NIBP cuff size
- NIBP auto cycle on/off information
- NIBP cycle time information if the NIBP auto cycle is on

The actions taken by the monitor and the menus that appear depend on whether the monitor has an active patient case/admitted patient or not.

How to continue monitoring when a case is not active/patient is discharged

When you connect a PDM or TRAM that is actively measuring vital signs from ECG, invasive pressures or SpO₂, the patient information and data is automatically loaded from the PDM or TRAM to the monitor and a case is automatically started/patient is admitted.

When you connect a PDM or TRAM that is not actively measuring vital signs from ECG, invasive pressure or SpO₂ but contains patient information, the **Continue** menu appears. The **Continue** menu has two informative fields on the top: the **Patient in the monitor** and the **Patient in the PDM** or **Patient in the Tram**. These fields show the text **No patient identification data available** if there is no active case/admitted patient. Select one of the following to continue monitoring:

- **Load PDM Data / Load Tram Data**: This selection loads patient information and data from the module.

- **Erase PDM Data / Erase Tram Data:** This selection erases the patient information and data from the module.

How to continue monitoring when a case is active/patient is admitted

When you connect a PDM or TRAM that contains an MRN that matches the MRN entered on the monitor, the patient information and data is automatically loaded from the PDM or TRAM to the monitor and a case is automatically started/patient is admitted.

When you connect a PDM or TRAM that contains patient information but the MRN does not match the MRN entered on the monitor, the **Continue** menu appears.

NOTE

When data is combined either automatically or manually, only the data after the last module disconnection is loaded. To load all trends, discharge the patient from the monitor and make sure that the PDM/TRAM is not connected to the monitor. Then reconnect the module.

The **Continue** menu has two informative fields on the top: the **Patient in the monitor** and the **Patient in the PDM** or **Patient in the Tram**. These fields show the MRN and Name of the Patient information if there is an active case/admitted patient. Select one of the following to continue monitoring:

- **Load PDM Data / Load Tram Data:** This selection erases the patient data from the monitor and loads the data from the module.
- **Continue Current:** Monitoring will continue with the patient data from the monitor. If the patient identification is not the same on the acquisition module and the monitor, this selection erases the patient data from the monitor and continues with the patient currently on the module.
- **Erase PDM Data / Erase Tram Data:** This selection erases the patient data from the module.
- **Combine Data:** This selection combines the patient data from the module with that of the monitor even if the patient identification is different or it has not been entered. Use this selection if no MRN has been entered or you know for certain that you will continue monitoring the same patient. This selection may also be useful if there has been a typing mistake or some other minor error when entering the patient identification. Any information available in one device and not in the other will overwrite the missing information. Be careful when using this selection. If you are not absolutely certain that it is the same patient on the monitor and module, do not combine the data.
- **Discharge:** This selection deletes the patient data from the module and from the monitor.

If you connect a PDM or TRAM module and there is no patient information or data in the module or in the monitor, the monitoring does not start and the **Continue** menu does not appear.

When you select to erase data or discharge a patient in the **Continue** menu, the patient's vital signs cannot be observed during the erase/discharge cycle time.

If the **Continue** menu is open when a request for time adjustment is received, the adjustment will be delayed until the menu is closed and data has been loaded.

If a PDM or TRAM is connected to the monitor when the time is adjusted, the monitor sends the new time to the module.

About case reset/patient discharge

Resetting a case/discharging a patient deletes all patient information from an attached PDM or TRAM. If this is not desired, disconnect the PDM or TRAM from the monitor before resetting a case/discharging the patient.

The monitor may be configured with an automatic case reset/patient discharge timer. If this is configured and vital signs are no longer detected, monitoring will end automatically after the configured time has elapsed.

The patient can be discharged remotely using a central station provided that this option has been enabled. This option is not available in OR and PACU software packages. However, if there is a pending automatic software or settings update that will take place after the patient discharge, remote discharge is not possible. The discharge option will then be disabled at the central station.

Pending software or setting activation

If there is a pending software or setting activation, it is indicated with the messages **Software activation after next discharge / Software activation after next case end**, or **Setting activation after next discharge / Setting activation after next case end**. When you reset a case/discharge a patient, this activation will automatically take place. Follow the instructional texts that appear on screen.

NOTE

If the pending activation cannot be allowed to take place and must be canceled for some reason, contact authorized service personnel.

Residual physiological data

To ensure that no physiological data remains in the acquisition module or in the bedside monitor after resetting a case/discharging the patient, do the following:

- PDM: Do not disconnect the acquisition module from the bedside monitor before ending a case or discharging a patient. You must also disconnect all the patient cables from the patient. The PDM can continue to measure patient data with battery power even when the module is not connected to the patient monitor.
- Bedside monitor: Remove the acquisition modules from the monitor or disconnect all the patient cables from the patient.

Resetting a case/discharging a patient

1. Disconnect patient cables.
2. Print necessary data and wait until the printing is completed.
3. Select the patient information field on the screen.
4. Select the **Patient** tab.
5. Select **Reset Case** or **Discharge Patient**.

Monitor settings, including alarm limits, return to their default settings. All patient data and trend data is removed from both the monitor and a connected PDM or TRAM.

Resetting a case/discharging a patient in combination monitoring mode

NOTE

Not with NICU software packages.

1. Disconnect patient cables.
2. Print necessary data and wait until the printing is completed.
3. Select the patient information field.
4. Select the **Patient** tab.
5. Select **Reset Case** or **Discharge Patient** and one of the following:
 - **No**: No discharge actions take place.
 - **Telemetry**: The patient is discharged from the telemetry transmitter but not from the monitor.
 - **Monitor**: The patient is discharged from the monitor but not from the telemetry transmitter.
 - **Both**: The patient is discharged from the monitor and the telemetry transmitter.

Alarms

Alarm warnings

- WARNING** When the alarms are off or while alarm audio is paused either temporarily or indefinitely, observe the patient frequently.
- WARNING** Always make sure that the audio alarm volume level is adequate in your care environment.
- WARNING** Always make sure that the alarm light brightness is adequate in your care environment.
- WARNING** Always make sure that necessary alarm limits are active and set according to the patient's clinical condition when you start monitoring a patient.
- WARNING** Verify alarm processing is active and check the patient to ensure no arrhythmias occurred during a power interruption.
- WARNING** Always check the alarm status after a prolonged power interruption.
- WARNING** Alarms do not sound, alarm histories are not stored, alarm graphs do not print, and alarms are not sent to the network when the alarms are turned off.
- WARNING** Alarms do not sound and alarms are not sent to the CARESCAPE Network during Audio Pause.
- WARNING** The audible alarm signal may be paused temporarily from a central station or remote monitor.
- WARNING** To avoid missed detection of critical alarms, always inform personnel dependent on the CARESCAPE monitor alarms of remote alarm silencing or pausing interactions.
- WARNING** The peripheral device's alarms must not be turned off or the volume reduced in any way to diminish the importance of the peripheral device as the primary alarm source for parameters monitored by the peripheral device.
- WARNING** There are no alarm indications until parameter-specific alarm prerequisites have been met.

- WARNING** A maximum of four beds can be displayed in the alarm area at one time, five beds when no local alarms are present. Do not use automatic view on alarm (AVOA) as a replacement for a primary alarm source or as a central station.
- WARNING** Only the most recent, highest priority alarm is sent to remote devices on the CARESCAPE Network. Therefore, less recent alarms of equal or lower priority may not be displayed or may not be indicated with their associated priority remotely.
- WARNING** Alarm messages may not be visible on the alarm display area when three higher priority alarms are active.
- WARNING** Alarm messages may not be visible on the alarm display area when one higher priority local alarm and four remote alarms are active.
- WARNING** Latched alarms are not retained through a monitor reset if the alarm condition has been removed.
- WARNING** The secondary alarm system shall not be relied upon for receipt of alarm signals.
- WARNING** Equipment malfunctions, network disconnection, nurse call disconnection (B850), and alarm volume settings may result in missed alarms. Always keep the patient under close surveillance.
- WARNING** — MIXED ENVIRONMENT— A hazard can exist when the same type of monitors in the same care area are using different monitoring profiles and default configuration settings.
- WARNING** — MISSED ALARM — Do not rely on receipt of certain alarm conditions at a central station, remote bedside, or alarm notification device when connected to the CARESCAPE Network. Notification of any of these alarms will only be given when it is the most recent, highest priority active alarm coming from the bedside monitor. This applies to those limit alarms and technical alarms that are defined as broadcast only alarms in this manual.
- WARNING** Reducing the physiological alarms' priority levels lower than the default level can lead to missed detection of critical events and therefore to adverse patient outcome. If you adjust the priority levels for V Tach, Tachy, Brady, HR high/low, PR high/low, SpO₂ low, RR (Impedance) high/low, RR (CO₂) high/low, Apnea (Impedance), Apnea (CO₂), NIBP, IP, or CPP alarms lower than the default value, keep the patient under close surveillance.
- WARNING** Reducing the technical alarms' priority levels lower than the default level can lead to missed detection of critical events and therefore to adverse patient outcome. If you adjust the priority levels for ECG Leads off, Noisy ECG, Arrhythmia paused, Telemetry battery low, or SpO₂ probe off alarms lower than the default value, keep the patient under close surveillance.

- WARNING** If **Alarm Setup > Audible & Visual > Pause All Audio for 5 min** or the 2 minute audio pause is selected before an alarm is triggered, only the alarms for hypoxic gas mixture (**FiO2 low, EtO2 low, FiN2O high**), and the alarm for dangerously high airway pressure (**Ppeak high**: measured Ppeak exceeds the set high alarm limit by 10 cmH₂O) will break through. The pause audio behavior is configured in the **Care Unit Settings** and the setting is password protected.
- WARNING** When connecting PDM or TRAM, the loaded IP labels may affect the channel labeling of other already connected channels, and consequently also the alarm limits.
- WARNING** B650: Secondary displays do not sound audible alarms. Keep the patient under close surveillance.
- WARNING** B850: Using other displays than the B850 system specific ones may result in loss of visual alarms and patient monitoring.
- WARNING** Do not connect a monochrome display to the monitor. Visual alarm indicators may not appear properly.

Alarm cautions

- CAUTION** Reducing the physiological alarms' priority levels lower than the default level can lead to missed detection of serious events and therefore to adverse patient outcome. If you adjust the priority levels for non-lethal arrhythmias, FiCO₂ and/or EtCO₂ alarms lower than the default value, keep the patient under close surveillance.

Alarm overview

Alarm types

The monitor provides two types of alarm settings, system and patient-specific. System alarm settings are set globally across an entire care environment. They are configured at the time of installation and are password protected. Examples of configurable system alarm settings are:

- Minimum alarm volume allowed
- Audio and alarm light off allowed
- Absolute (Guard) limit setting

Patient-specific alarm settings are individualized, based on a patient's current condition. Examples of bedside alarm settings are:

- Parameter alarm limits
- Arrhythmia alarm priority settings

Alarm conditions

- Physiological alarm conditions are triggered by a patient measurement being outside the parameter limits, by apnea, or by an arrhythmia condition.

- Technical alarm conditions are triggered by an electrical, mechanical, or other failure of the equipment, or by failure of a sensor or component. Technical alarm conditions may also be caused when an algorithm cannot classify or interpret the available data. The visual manifestation of a technical alarm is active as long as the reason for that alarm exists.
 - Certain technical alarms can be deactivated with the pause audio key. The **Alarm Deactivation** setting is configured in the **Care Unit Settings** and it is password protected. For more information, see the supplemental information manual.

Alarm priority levels

Physiological and technical alarms are categorized by priority level:

- High priority alarms require an immediate response.
- Medium priority alarms require a prompt response.
- Low priority alarms require you to be aware of this condition.
- Informational priority messages provide information you should know.

NOTE Informational messages are not sent to the network, and they are never latched.

Alarm priority escalation

An escalating alarm starts at a designated priority level (low or medium) and will escalate to the next higher priority level of alarm (after a set number of seconds) if the alarm condition has not been resolved. It is important to note that these escalate up to the next level but will not reset until the condition has been resolved.

NOTE Alarm priority escalation affects the currently ongoing alarm condition, not any future alarms of the same type. Any new alarms will alarm at their designated priority level, not at the escalated level.

For more information, see the supplemental information manual.

Physiological alarms' activation criteria

Physiological alarms have individual activation criteria as shown in the table. Alarm annunciation does not depend on case activity.

Parameter	Alarm activation criteria
ECG	Active measurement for 30 seconds.
Impedance respiration	Active measurement for 30 seconds.
SpO ₂	Active measurement for 60 seconds.
NIBP	Manual , Auto , or Stat mode started.
IP	Active measurement for 30 seconds.
Temperature	Active as soon as measurement readings are available.
C.O.	Active as soon as continuous measurement readings are available from the Unity Network Interface Device (ID).
SvO ₂	Active as soon as measurement readings are available.

Parameter	Alarm activation criteria
Gases	Active measurement for 60 seconds without apnea.
Patient Spirometry	Active if module connected and communicating with the monitor.
Entropy	Measurement readings within the preset alarm limits for 30 seconds.
EEG	EEG present and active for 15 seconds.
BIS	Active measurement for 30 seconds.
TC	Active measurement for 60 seconds.

NOTE

If the monitor is connected to the network, the alarms can be heard and seen at the central station. See the central station user's manual for details.

Broadcast only alarms

Alarms are sent to the CARESCAPE Network and displayed on the central station or remote monitor according to the following mapping.

Feature	Message on the bedside monitor	Message sent to the CARESCAPE Network and displayed on the central station/remote monitor
ECG	<i>HR(ECG) high</i>	<i>HR(ECG) HIGH</i>
ECG	<i>HR(ECG) low</i>	<i>HR(ECG) LOW</i>
ECG	<i>ST Ant high</i>	<i>ST ANT HIGH</i>
ECG	<i>ST Ant low</i>	<i>ST ANT LOW</i>
ECG	<i>ST Inf high</i>	<i>ST INF HIGH</i>
ECG	<i>ST Inf low</i>	<i>ST INF LOW</i>
ECG	<i>ST Lat high</i>	<i>ST LAT HIGH</i>
ECG	<i>ST Lat low</i>	<i>ST LAT LOW</i>
ECG	<i>QT high</i>	<i>QT HIGH</i>
ECG	<i>QTc high</i>	<i>QTC HIGH</i>
ECG	<i>Remove one ECG module</i>	<i>REMOVE 1 ECG</i>
ECG	<i>ECG measurements removed</i>	<i>ECG REMOVED</i>
ECG	<i>PDM module removed</i>	<i>PDM REMOVED</i>
ECG	<i>PSM/PRESTN module removed</i>	<i>PSM REMOVED</i>
ECG	<i>Tram module removed</i>	<i>TRAM REMOVED</i>
NIBP	<i>NIBP measurement removed</i>	<i>NIBP REMOVED</i>
NIBP	<i>Check NIBP</i>	<i>CHECK NIBP</i>
NIBP	<i>NIBP manual</i>	<i>NIBP MANUAL</i>
SpO ₂	<i>Identical SpO2 modules</i>	<i>SPO2 IDENT</i>
SpO ₂	<i>SpO2 measurement removed</i>	<i>SPO2 REMOVED</i>
Patient Spirometry	<i>PEEPtot high</i>	<i>PEEPTOT HIGH</i>

Alarms

Feature	Message on the bedside monitor	Message sent to the CARESCAPE Network and displayed on the central station/remote monitor
Patient Spirometry	<i>PEEPtot low</i>	PEEPTOT LOW
Patient Spirometry	<i>PEEPe high</i>	PEEPE HIGH
Patient Spirometry	<i>PEEPe low</i>	PEEPE LOW
Patient Spirometry	<i>PEEPi high</i>	PEEPI HIGH
Patient Spirometry	<i>PEEPi low</i>	PEEPI LOW
Patient Spirometry	<i>MVexp high</i>	MVEXP HIGH
IP	<i>No Px transducer</i>	NO PX TRANSD
IP	<i>Pressure measurement removed</i>	IP REMOVED
IP	<i>Identical IP modules</i>	IDENTICAL IP
C.O.	<i>CO measurement removed</i>	CO REMOVED
C.O.	<i>Identical C.O. modules</i>	IDENTICAL CO
Temperature	<i>Tblood-T1 high</i>	TBL-T1 HIGH
Temperature	<i>Tblood-T3 high</i>	TBL-T3 HIGH
Temperature	<i>Identical temperature modules</i>	TEMP MOD ERR
Temperature	<i>Temp measurement removed</i>	TEMP REMOVED
SvO ₂	<i>SvO2 cable off</i>	SVO2 CABL OFF
SvO ₂	<i>SvO2 measurement removed</i>	SVO2 REMOVED
Gases	<i>Gas measurements removed</i>	GAS REMOVED
Gases	<i>Identical gas modules</i>	MODULE ERROR
Entropy	<i>Entropy RE high</i>	RE HIGH
Entropy	<i>Entropy RE low</i>	RE LOW
Entropy	<i>Entropy SE high</i>	SE HIGH
Entropy	<i>Entropy SE low</i>	SE LOW
Entropy	<i>Identical Entropy modules</i>	ENTROPY IDENT
Monitor battery	<i>Monitor battery empty!</i>	BATTERY EMPTY
Monitor battery	<i>Monitor powering down!</i>	POWERING DOWN
Service	<i>Service Monitor - and specific error code</i>	SERVICE HOST
Service	<i>Service Monitor Possible Data Corruption</i>	SERVICE TRAM
Service	<i>Power management failure</i>	POWER FAILURE
Service	<i>Service the PDM and specific error code</i>	SERVICE PDM
Service	<i>Speaker failure</i>	SPEAKER FAIL
Service	<i>Module voltage low</i>	MODULE V LOW
Service	<i>Service gas module - and specific error code</i>	SERVICE SGAS





Checking alarm function

1. Set a parameter alarm limit outside of the current measured patient values. For example, connect the SpO₂ sensor and adjust the SpO₂ high limit under the measured SpO₂ values.
2. Confirm that the following alarm notification events occur:
 - The audible alarm sounds the correct tone.
 - The alarm light illuminates.
 - The SpO₂ numeric value flashes in the parameter window with the correct color.
 - An alarm printout (if enabled).
3. Audio pause the alarms and confirm that the alarms are paused and that the left side of the alarm indicator light is a solid blue color.
4. Return the parameter alarm limit to the original value.

Alarm indications

Alarm icons on the screen

	Pause audio alarms - Selectable from the monitor's main menu. Also an indicator of a temporarily paused active audio alarm.
	Audio alarms paused indicator with countdown timer - Indicates all audio alarms are paused and the amount of time remaining for the alarm pause period displays as a countdown timer. Displays in the upper left corner of the screen.
	Audio alarms off indicator - Displays in the upper left corner of the alarm area when physiological audible alarms are turned off.
	Alarm off indicator - Displays in the upper right corner of the parameter window and in the Alarms Setup menu when physiological alarms for this parameter are turned off. The symbol may not display at the central station or on a remote bedside monitor.
	Low priority audio off alarm indicator. Displays in the upper left corner of the alarm area.
	Configuration warning. Displays when the priority setting for Tachy/Brady PR high/low or HR/PR high/low , or SpO2 low has been set to low. Check the alarm configuration. Displays in the upper left corner of the alarm area.
	General warning sign. Displays when the priority setting for Tachy/Brady PR high/low or HR/PR high/low , or SpO2 low has been set to low. Displays in the lower part of the parameter menus' Alarms tab, and in the Priority column of the selected alarm in the Alarm Setup > Alarm Priorities .

	Alarm priority indicator: High (red). Indicates a high priority alarm.
	Alarm priority indicator: Medium (yellow). Indicates a medium priority alarm.
	Alarm priority indicator: Low (cyan). Indicates a low priority alarm.
	Alarm volume indicator. Adjust the minimum alarm tone volume.

Description of alarm and information messages

Alarm and information messages can be displayed in three areas:

- The parameter window
- The waveform field
- Alarm area (upper part of the screen)

In the alarm area, up to five alarm or information messages may be displayed from left to right, from the newest highest priority alarm to the oldest lowest priority alarm. Up to four newest highest priority remote alarm messages display first, followed by the newest highest priority local alarm messages.

Alarm and information messages are stored in the clinical logs. Access to the clinical logs is a service-level function and it is password protected. The alarm and information messages stored in the clinical logs include:

- Time of occurrence
- Alarm or information message text
- Current value and the associated alarm limit if a limit alarm (local only)

Setting the alarm light brightness

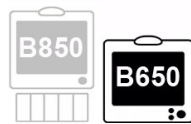

B650: The monitor has an integrated alarm light.



B850: Some displays have an alarm light.

1. Select **Alarm Setup** from the monitor's main menu.
2. Select the **Audible & Visual** tab.

3. Select an **Alarm Light %** value.

The greater the value, the brighter the light.

Audible alarm signals

When more than one alarm occurs at the same time, the monitor will sound an alarm tone for the highest priority alarm. Any lower priority audible alarm tones are suppressed by the higher priority alarm tone.

The most recent of the alarms that has the highest priority level at this moment is the alarm that is broadcast on the network. For example, if there is one medium-priority alarm and a low-priority alarm appears, the medium-priority alarm is broadcast, not the most recent (low-priority) alarm. If there is one medium-priority alarm and another medium-priority alarm appears, the latest alarm that appeared is broadcast.

Alarm tones

The alarm tones may be configured to sound in one of two different tone patterns: **Legacy** or **IEC**. **IEC** tones are 60601-1-8 compliant. **Legacy** alarm tones match the tones used on some previous GE monitoring devices.

For more information, see the supplemental information manual.

AVOA alarm tones may differ from the local monitor alarm tones. Both the highest priority local alarm tone and the highest AVOA alarm tone will sound, but in a sequence containing one local alarm tone pattern and one AVOA alarm tone pattern. If the same tones have been selected for AVOA and local alarms, then only the highest priority tone will sound.

Adjusting the alarm volume

The selections in the **Alarms Setup** menu vary according to what has been configured in the **Care Unit Settings > Alarms** (password protected).

1. Select **Alarm Setup** from the monitor's main menu.
2. Select the **Audible & Visual** tab.
3. Adjust the volume according to what is available in the menu:
 - Adjust the **Alarm Volume** value. This is the volume for all alarms.
 - Adjust the **Alarm Volume for:** separately for **High & Medium Priority** and **Low Priority**.

The lower the number, the quieter the alarm volume. Note that the minimum allowed alarm volume levels are set in the **Care Unit Settings**.

Audible and visual alarm signals

Alarm signals indicate that an alarm condition is present. The alarm priority levels are indicated by visual and audible signals. The visual and audible alarm signals assume that the patient monitor and the operator are within the patient environment (1.5 meters).

When physiological alarm messages are received from other monitors on the S/5 Network, only the most recent and highest priority message is shown. There are no flashing numerics or background color. No messages are shown in the parameter window area.

The following table lists alarm signals for different alarm priority levels:

Signal	Priority level			
	High	Medium	Low	Informational
Parameter window physiological data values	Black text flashes inside a red box.	Black text flashes inside a yellow box.	Black text inside a cyan (blue) box.	Not applicable.
Alarm area	White text inside a red box.	Black text inside a yellow box.	Black text inside a cyan (blue) box.	Black text inside a grey box.
Waveform field messages	Text	Text	Text	Text
Audible tone pattern ¹ (IEC 60601-1-8)	Repeats pattern of 2 * 5 beep tones	Repeats pattern of 3-beep tones	1-beep tone	None
Audible tone pattern (legacy)	Repeats pattern of 3-beep tones (crisis)	Repeats pattern of 2-beep tone (warning)	1- beep tone (advisory)	None
Alarm light indicator ²	Flashes red	Flashes yellow	Solid blue	No effect
Automatic view on alarm audible tone pattern	User configurable ³	User configurable ³	User configurable ³	None

¹ The IEC audible tone pattern is the factory default setting.

² When the audible alarms are turned off or are paused, the alarm Audio pause/off area of the Alarm light is a solid blue color.

³ The AVOA audible alarm tone pattern may be configured to match the local monitor's audible tone pattern, repeat a pattern of two beep tones, beep twice upon activation by an alarm condition, or be turned off. For configuring the AVOA audible alarm tone pattern, see the supplemental information manual.

Auditory information signals

The monitor performs a self-diagnostic procedure at start-up and generates an auditory test signal. There are also other auditory information signals indicating the status of some parameter measurements.

For more information, see the supplemental information manual.

Audible alarms off behavior

Depending on the **Audio Alarm** default settings configured during installation, you can turn on or turn off audible alarms.

For more information, see the supplemental information manual.

When audible alarms are turned off:

- All audible alarms are turned off except for any high priority alarms configured to break through the audio off setting.
- The audio off bell icon displays in the upper left corner of the display screen.
- The alarm audio pause/off area of the alarm light is solid blue when audible alarms are paused or when audio off is selected for an alarm group.

Turning audible alarms on/off

You can turn on/off the audible physiological alarm tones for an alarm group or for all alarms.

1. Select **Alarm Setup** from the monitor's main menu.
2. Select the **Audible & Visual** tab.

3. Select an alarm group. Choices are:
 - **None:** No audible alarms are turned off.
 - **Apnea Audio Off:** Turns off audible alarms for apnea, EtCO₂, FiCO₂, respiration rate, Ppeak low, PEEPe, PEEPtot, PEEPi, and MVexp limit alarms.
 - **ECG Audio Off:** Turns off audible alarms for all HR and PR source limit and arrhythmia alarms.
 - **Apnea & ECG Audio Off:** Turns off audio alarms for all HR and PR source limit, arrhythmia, apnea, EtCO₂, FiCO₂, respiration rate, Ppeak low, PEEPe, PEEPtot, PEEPi, and MVexp limit alarms.
 - **All Alarms Audio Off:** Turns off all audible alarms except some high priority alarms defined as breakthrough alarms.
4. To turn on all audible alarms again, select **Activate All Audible Alarms**, or select **None** as instructed above.



NOTE If alarms are turned off for any of the defined alarm groups and an alarm occurs within the alarm group, a beep tone will sound every 2 minutes as a reminder that alarms are turned off.



NOTE France only: A reminder beep tone sounds every 2 minutes when the **Audible & Visual > None** setting is not selected.

Pause audio behaviors

Selecting the pause audio key results in different alarm behaviors depending on whether the alarms are active and/or latched or not. Acknowledging or pausing audio alarms does not affect other alarm indicators. They will still continue indicating alarms.

When the monitor is on the network, alarms can also be paused and acknowledged at the central station.

Active and/or latched alarms	
Selection	Result
Select  once	<ul style="list-style-type: none"> • Pauses all active audio alarms for 2 minutes. • Removes all latched alarms. • Deactivates some technical alarms.
Second selection of  during the 2 minute pause	<ul style="list-style-type: none"> • Starts a 2 or 5 minute audio pause period for all alarms except the specified breakthrough alarms. The 2 or 5 minute duration is a care unit setting and password protected. • Removes all new latched alarms. <p>Some technical alarms may also be deactivated with this selection.</p>
Select  once during audio pause	<ul style="list-style-type: none"> • Ends the audio pause period. • Restores all acknowledged and silenced alarms if the alarm condition still exists.

No active or latched alarms	
Selection	Result
Select  once	<ul style="list-style-type: none"> Starts a 2 or 5 minute audio pause period for all alarms except the specified breakthrough alarms.
Select  once during audio pause	<ul style="list-style-type: none"> Ends the audio pause period. Restores all acknowledged and silenced alarms if the alarm condition still exists.

Pausing alarms for 5 minutes

You can pause audible alarms with the pause audio key for 2 or 5 minutes according to the care unit settings. You can also pause all alarms for 5 minutes through the **Alarms Setup** menu.

1. Select **Alarm Setup** from the monitor's main menu.
2. Select the **Audible & Visual** tab.
3. Select **Pause All Audio for 5 min**. This will pause all alarms, including the breakthrough alarms, except **FiO2 low**, **EtO2 low<18%**, **FiN2O low>82%**, and **Ppeak high**. It also removes latched alarms.

Activating all audible alarms

If necessary, you can activate all paused audible alarms before the 2 or 5 minute pause expires.

1. Select **Alarm Setup** from the monitor's main menu.
2. Select the **Audible & Visual** tab.
3. Select **Activate All Audible Alarms**.

Technical alarms' deactivation with the pause audio key

Certain technical alarms can be deactivated with the pause audio key. The **Alarm Deactivation** setting is configured in the **Care Unit Settings** and it is password protected.

For more information, see the supplemental information manual.

Technical alarms for which the deactivation with the pause audio key can be allowed are:

- **ECG Leads Off**
- **Art disconnect**
- **ABP disconnect**
- **Fem disconnect**
- **UAC disconnect**
- **SpO2 Probe Off**

Apnea alarms' deactivation with the pause audio key

Apnea alarms can be deactivated with the pause audio key if the **Allow alarm deactivation with the Audio Pause key for:** setting **Apnea (CO2/Imped)** is enabled in the **Care Unit Settings**. This setting is password protected.

For more information, see the supplemental information manual.

Pause audio with combination monitoring

When using combination monitoring, the pause audio behavior is the following:

- If the telemetry transmitter is in pause audio state, also the monitor will be in the same state. You can cancel the pause audio at the bedside monitor by selecting the pause audio key. This will not affect the telemetry device.
- If the monitor's own pause audio state ends before the telemetry transmitter's audio pause, the monitor will re-enter pause audio.
- The pause audio started by the telemetry transmitter will end also at the monitor when the transmitter's pause audio ends.

Breakthrough alarms

The breakthrough alarms feature allows pre-defined and user-selectable alarms to "break through" (interrupt) an **All Alarms Audio Off** or a 2 or 5 minute audible alarm pause condition.

The **FiO2 low**, **EtO2 low**, **FiN2O high**, and **Ppeak high** alarms will always break through when escalated to or activated at high priority alarm condition regardless of the **All Alarms Audio Off** selection or any alarm pausing.

The following alarms will break through when activated at high priority alarm condition regardless of the 2 to 5 minute audible alarm pause: **Asystole**, **V Fib/V Tach**, **V Tach**, and **Brady** (in the NICU software package only).

WARNING

If **Alarm Setup > Audible & Visual > Pause All Audio for 5 min** or the 2 minute audio pause is selected before an alarm is triggered, only the alarms for hypoxic gas mixture (**FiO2 low**, **EtO2 low**, **FiN2O high**), and the alarm for dangerously high airway pressure (**Ppeak high**: measured Ppeak exceeds the set high alarm limit by 10 cmH₂O) will break through. The pause audio behavior is configured in the **Care Unit Settings** and the setting is password protected.

Latched alarms

When alarms are latched, the audible alarm and visual message remains after the alarm condition no longer exists. The audible alarm can be paused with the pause audio key, and this also clears the alarm message from the screen. Alarms can be configured to latch for high priority alarms only, all alarm priorities, or none. The **Latching Alarms** setting is configured in the **Care Unit Settings** and it is password protected.

For more information, see the supplemental information manual.

Setting parameter alarm limits

Parameter alarm limits may be set in the **Alarms Setup** menu, or in the parameter menus' own **Alarms** tab. Alarm limits should not be set beyond reasonable physiological boundaries in order to maintain patient safety. Setting outside of reasonable boundaries would cause the alarms to be ineffective.

1. Select **Alarm Setup** from the monitor's main menu.
2. Select the **Alarm Limits** tab.
3. Select a parameter label.

If you are unable to find a specific parameter, select the right arrow to display additional labels. If the parameter limit has been turned off, the alarm limit will be greyed out.

Selecting a parameter label takes you to that parameter menu's **Alarms** tab where you can select alarms on or off, and set their limits.

Alarm locks

Alarm locks prevent parameter alarm limits from being turned off. When an alarm is locked, a lock icon appears next to the **Alarm On/Alarm Off** setting. Parameter alarm locks are set in the **Care Unit Settings** and they are password protected.

For more information, see the supplemental information manual.

Alarm guard limits

Alarm guard limits prevent parameter alarm limits from being adjusted above (high) or below (low) these values. When an alarm has a guard limit, there is a gray guard indicator in the alarm adjustment dialog. Alarm guard limits are set in the **Care Unit Settings** and they are password protected.

For more information, see the supplemental information manual.

Setting arrhythmia alarms

You can set the arrhythmia alarms in the **Alarms Setup** menu, or in the **ECG** menu.

1. Select **Alarm Setup** from the monitor's main menu.
2. Select the **Arrhythmia** tab.
3. Select **Lethal Alarms**.

You can now select the **Alarm Priority**, **Create Snapshot**, and **Print on Alarm** options per arrhythmia.

4. If Full Arrhythmia license is enabled, you can also select options for the **Atrial Alarms** and **Ventricular Alarms**.
 - **Ventricular Alarms:** You can select the **Alarm Priority**, **Create Snapshot**, and **Print on Alarm** options.
 - **Atrial Alarms:** You can select the **Alarm Priority**, **Create Snapshot**, and **Print on Alarm** options. In addition, you can set the detection criteria for **SV Tachy: SVT Length**, **HR for SVT /min**, and **Pause Interval**.

Selecting parameter alarm priority levels

Escalating an alarm priority increases the priority of the alarm condition or increases the sense of urgency of an alarm signal. The alarm priority is based on clinical considerations.

The allowed priorities for different alarm groups are defined in the **Care Unit Settings** and they are password protected.

For more information, see the supplemental information manual.

1. Select **Alarm Setup** from the monitor's main menu.
2. Select the **Alarm Priorities** tab.
3. Select the alarm group: **ECG**, **Invasive Pressures**, or **Other Parameters**.
4. Select the alarm and its priority from the list.

Selectable alarms are:

ECG	Invasive pressures	Other parameters
HR/PR high/low (TRAM, telemetry) or Tachy/Brady PR high/low (PSM, PDM) Selecting the low priority will display the general warning sign.	Art high/low	SpO2 high
ST Segment high/low	ABP high/low	SpO2 low Selecting the low priority will display the general warning sign.
Frequent PVCs	Fem high/low	SpO2 probe off
Frequent SVCs	CVP high/low	NIBP high/low
ECG leads off	FemV high/low	CO2 high/low
Noisy ECG	PA high/low	FiAA high/low
Arrhythmia paused	RAP high/low	Apnea (CO2)
Change telemetry battery Also the informational level is available for this alarm.	RVP high/low	Apnea (Impedance)
	LAP high/low	RR (CO2) high/low
V Tach Although the low and medium priority settings are allowed for V Tach , the alarm will always be high priority if the V Tach duration is more than 30 seconds, the HR is higher than the set HR high limit, and the HR exceeds 150 beats/min. In the NICU software package the high priority is enforced at 180 beats/min.	ICP high/low	RR (Impedance) high/low
	CPP high/low	TcCO2 high/low
	P1 high/low to P8 high/low	TcO2 high/low
		CCO high/low
		CCI high/low

According to what has been allowed in the **Care Unit Settings**, the selectable priorities are:

- **Escalating, High, Medium, Low**, or
- **Escalating, High, Medium**, or
- **Escalating, High**.
- For **Apnea (Impedance)** also **Escalating, High, Medium, Low, Informational** may be allowed.

Setting alarm limits automatically

When selected, the **Auto Limits** feature automatically sets new high limit and low limit values, based upon the current physiological value. The **Auto Limits** should only be used for patients whose currently measured values are considered safe.

1. Select **Alarm Setup** from the monitor's main menu.
2. Select the **Alarm Limits** tab.
3. Select **Auto Limits**.

If you need to undo these changes and return to the previous alarm limit settings, select **Undo Settings** before closing the menu.

Default auto alarm limits

Parameter	High limit	Low limit
NIBP	S/D/M: NIBP*1.25+10	S/D/M: NIBP*0.75-10
All HR/PR parameters (ECG, SpO ₂ , UAC, Art, ABP, Fem)	All HR*1.25 of the current HR value (averaged over last 10 s)	All HR*0.75 of the current HR value(averaged over last 10 s)
ST group	Greatest value in group: +1 if group is enabled, otherwise limit is +2	Smallest value in group: -1 if group enabled, otherwise limit is -2
ST individual	ST+1 if enabled, otherwise limit is +2	ST-1 if enabled, otherwise limit is -2
PVC	PVC+10	Not applicable
EtCO ₂	EtCO ₂ +5%	EtCO ₂ -5%
SpO ₂	SpO ₂ +5%	SpO ₂ -5%
Art, ABP, Fem, P1	Sys/Dia/Mean: Value*1.25+10mmHg Value*1.25+1.3kPa	Sys/Dia/Mean: Value*0.75-10mmHg Value*0.75-1.3kPa
FemV, CVP, PA, RAP, RVP, LAP, ICP, CPP, P2-8	Sys/Dia/Mean: Value*1.25+5mmHg Value*1.25+0.67kPa	Sys/Dia/Mean: Value*0.75-5mmHg Value*0.75-0.67kPa
UAC/UVC	Sys/Dia/Mean: Value*1.25+5mmHg Value*1.25+0.67kPa	Sys/Dia/Mean: Value*0.75-5mmHg Value*0.75-0.67kPa
SvO ₂	SvO ₂ +5%	SvO ₂ -5%

Parameter	High limit	Low limit
Temperature, T _{Blood}	T _x +1°C T _x +1.8°F	T _x -1°C T _x -1.8°F
T _x -T _y (e.g., T ₂ -T ₁)	T _x -T _y +1°C T _x -T _y +1.8°F	T _x -T _y -1°C T _x -T _y -1.8°F
P _{peak}	P _{peak} +10 cmH ₂ O	P _{peak} -10cmH ₂ O
PEEP _{tot}	PEEP _{tot} +5cmH ₂ O	PEEP _{tot} -5cmH ₂ O
PEEP _e	PEEP _e +5cmH ₂ O	PEEP _e -5cmH ₂ O
MV _{exp}	MV _{exp} +2	MV _{exp} -2
RR	RR*1.25+2	RR*0.75-2

Returning the default alarm limits

1. Select **Alarm Setup** from the monitor's main menu.
2. Select the **Alarm Limits** tab.
3. Select **Default Limits**.

If you need to undo these changes, select **Undo Settings** before closing the menu.

Turning off all local alarm indicators (sleep mode)

NOTE This feature is not available with OR and PACU software packages.

If the feature has been enabled in the **Care Unit Settings** (password protected), you can turn off the monitor's display and turn off all audible, visual, and alarm light alarm indicators until you turn them back on again. Patient monitoring is occurring; however, the monitor is not displaying patient data or indicating patient alarms locally. Local printing is also inactive. Alarms are logged and trended. If the monitor is connected to the network, alarms and alarm printouts, and parameter data (and nurse call signals with B850) will continue to be sent over the network during sleep mode. For more information on enabling or disabling the **Audio&Display > Off Allowed** feature, see the supplemental information manual.

1. Select **Alarm Setup** from the monitor's main menu.
2. Select the **Audible & Visual** tab.
3. Select **Audio&Display > Off**.

A screen saver replaces the display of patient data. Any user input (touchscreen, button, Trim Knob, keyboard key, mouse click) reactivates the alarms and the monitoring screen.

Remote management of alarms

The remote alarm settings are defined in the **Care Unit Settings** and they are password protected. The following settings are available:

- Allowing remote audio pause from this monitor for a remote bed.

- Allowing audio pause for this monitor from a central station or remote monitor. Not available with the OR software package.
- Allowing remote pausing of different alarm priorities.
- Showing the remote patient name.
- Turning the remote monitor’s alarm light on or off.
- Selecting the remote alarm notification tone.

For more information, see the supplemental information manual.

Alarm settings after a power loss

If the monitor loses power, the amount of time without power affects whether or not you need to reset the alarm settings.

Power loss duration	Alarm setting status after a power loss
Up to 15 minutes	The alarm settings that are in effect before the power loss are restored automatically.
Greater than 15 minutes	The alarm settings revert back to the user default settings (start-up mode). You must reconfigure any patient-specific alarm settings.

Alarm data stored in Clinical logs

Access to the Clinical logs is a service-level function and it is password protected.

The monitor stores a record of patient-related local and remote alarms and information messages as well as any adjustments to the alarm limits in the Clinical logs.

Stored alarm data during a power cycle or power loss

If the monitor goes through a power cycle or a loss of power, the stored alarm data is not affected. The alarm data remains stored in the Clinical log until the monitor automatically clears the oldest stored data to allow new data to be stored.

ECG

ECG compatibility limitations

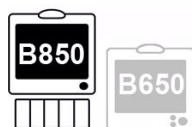

TRAM and Tram-Rac modules with the B850 only.

For detailed information regarding module, monitor, and accessory compatibility, see the supplemental information manual.

ECG safety precautions

ECG warnings

- | | |
|----------------|---|
| WARNING | Make sure that the leadwire set clips or snaps do not touch any electrically conductive material including earth. |
| WARNING | <p>When using an electrosurgery unit, note that the measurement cables do not incorporate means to protect against burns in case of a defective ESU return electrode. To avoid burns at the monitor measurement sites, ensure the following:</p> <ul style="list-style-type: none"> • Proper contact of the ESU return electrode to the patient. • ESU return electrode near the operating area. • Measurement electrodes, leadwires and probes far from the surgical site and the ESU return electrode. |
| WARNING | This device is intended to record electrocardiograms from surface ECG electrodes. It is not meant for positioning (floating) temporary pacemaker leadwires, performing pericardiocentesis, or other internal applications. |
| WARNING | The Maximum filter may alter the displayed ECG morphology. Do not make measurements from the displayed or printed ECG when this filter is selected. Displayed ST values are calculated before applying the Maximum filtering and may differ from values measured from the displayed or printed ECG. |

- WARNING** This device uses a computerized 12 lead ECG analysis program, which can be used as a tool in generating ECG records that provide ECG measurements and interpretative statements from the ECG recordings. The interpretive statements are only significant when used in conjunction with clinical findings. All ECG records should be overread by a qualified physician. To ensure accuracy, use only the ECG records for physician interpretation.
- WARNING** When transitioning from a 10-lead cable to a 5-lead cable, select the **Update Lead Set** option to clear the **Lead off** message from the display.
- WARNING** Disconnected electrodes or loose electrode connections can lead to missed critical severity ECG alarms. If the monitor reports **Leads off** after selecting **Update Lead Set** option, always check the electrode connections to the patient.
- WARNING** — CONDUCTIVE CONNECTIONS — Extreme care must be exercised when applying medical electrical equipment. Many parts of the human/machine circuit are conductive, such as the patient, connectors, electrodes, transducers. It is very important that these conductive parts do not come into contact with other grounded, conductive parts when connected to the isolated patient input of the device. Such contact would bridge the patient's isolation and cancel the protection provided by the isolated input.
- WARNING** — DELAYED ASYSTOLE ALARM — The pulsatile heart rate may have a slower response time than the electrical heart rate where there is a low perfusion patient condition. When using the IntelliRate feature in this situation, the monitor may delay calling an ASYSTOLE patient alarm. The user may elect to turn the IntelliRate feature off for patients at risk of these events, otherwise patient treatment may be delayed. Such patients should always be kept under close observation.
- WARNING** — NOISY ECG alarm — The **Noisy ECG** alarm indicates that the system is no longer monitoring ECG and there may be no **HR high, HR low, Tachy** or **Brady** alarms. If you adjust the alarm priority level lower than the default value, keep the patient under close surveillance.
- WARNING** — INACCURATE HEART RATE INDICATION — PDM — The electrical and pulsatile heart rate values provided by the various monitored parameters (ECG, SpO₂, blood pressures) may differ markedly. These differences may be due to underlying physiologic conditions (e.g., electromechanical dissociation, pulseless electrical activity, non-perfusing rhythms) or to inaccuracies in the heart rate values caused by artifact, poor signal quality, or arrhythmias. The user may elect to turn the IntelliRate feature off for patients at risk of these events, otherwise patient treatment may be delayed. Such patients should always be kept under close observation.

- WARNING** — ELECTRODES — Whenever patient defibrillation is a possibility, use non-polarizing (silver/silver chloride construction) electrodes for ECG monitoring. Polarizing electrodes (stainless steel or silver constructed) may cause the electrodes to retain a residual charge after defibrillation. A residual charge will block acquisition of the ECG signal.
- WARNING** — DEFIBRILLATOR PRECAUTIONS — Patient signal inputs labeled with the CF and BF symbols with paddles are protected against damage resulting from defibrillation voltages. To ensure proper defibrillator protection, use only the recommended cables and leadwires.
- WARNING** — HEART RATE ALARM INTERFERENCE — Poor cable positioning or improper electrode preparation may cause line isolation monitor transients to resemble actual cardiac waveforms and thus inhibit heart rate alarms. To minimize this problem, follow proper electrode placement and cable positioning guidelines provided with this product.

ECG cautions

- CAUTION** The patient's skin may become irritated after prolonged contact with electrode gel or adhesive.
- CAUTION** To assure accurate 12 lead analysis when using a 10-leadwire patient cable, you must verify that the correct leadwire block is plugged into the appropriate side of the cable. The V2 through V6 leadwire block is color-coded brown (AHA) or white (IEC).

ECG measurement limitations

- E-modules used for this measurement are not suitable for use with neonatal patients.
- The monitor will display a **Leads off** message in an input overload condition, or upon disconnection of electrode leadwires.

ECG points to note

- Pre-gelled ECG electrodes are recommended. Check the expiration date.
- Make sure the electrode gel is moist.
- Make sure the electrodes have good skin contact.
- Replace all electrodes at least every 24 to 48 hours.
- Use the Multi-Link electrosurgical unit (ESU) ECG patient cable when using the monitor in the presence of an electrosurgical unit. This cable, with a built-in ESU filter, helps reduce electrosurgical noise detected on the ECG signal.
- E-modules: Whenever a cable, electrode or V-lead is changed, the monitor automatically relearns.
- Depending on the ECG module used, not all ECG measurements and settings are available to view or change.
- Select the **Deactivate ECG Leads Off** option to remove a **Leads off** message from the display when a cable is off.

ECG measurement setup

ECG equipment to patient connection

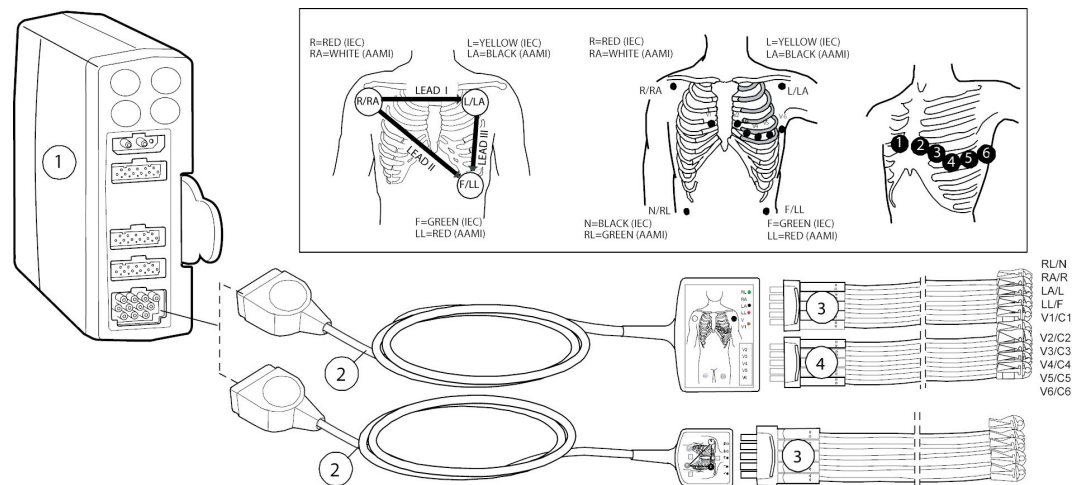

1. Module with ECG measurement capability
2. AAMI/AHA or IEC Multi-Link 3/5-lead, 6-lead, or 12-lead ECG cable
3. AAMI/AHA or IEC 3-leadwire, 5-leadwire, or 6-leadwire set
4. AAMI/AHA or IEC precordial leads leadwire set

NOTE

For measuring ECG with telemetry system, connect the leadwire set to the telemetry transmitter.

Preparing the patient's electrode sites

Excessive body hair or skin oil reduces electrode contact with the skin and decreases the quality of electrode signal. When preparing the electrode sites, avoid bones close to skin, obvious layers of fat and major muscles.

1. Shave any hair from the electrode site.
2. Gently rub the surface of the skin to increase capillary blood flow.
3. Clean the skin with alcohol or a mild soap and water solution to remove skin oil and dead or abraded skin cells.
4. Dry the skin completely before applying the electrodes.

Applying the electrodes to the patient

1. Place the electrodes on the prepared sites.
2. Stabilize the electrode and leadwire with a leadwire stress loop near the electrode.

3. Tape the stress loop to the patient (excluding neonates).

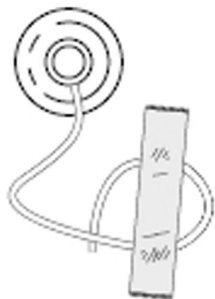

A secured stress loop prevents leadwire rotation about the electrode snap, leadwire tugging at the electrode, and ECG artifact.

3-lead or 5-lead ECG electrode placement

For a 3-leadwire electrode placement, the R/RA, L/LA, and F/LL electrodes should be used.

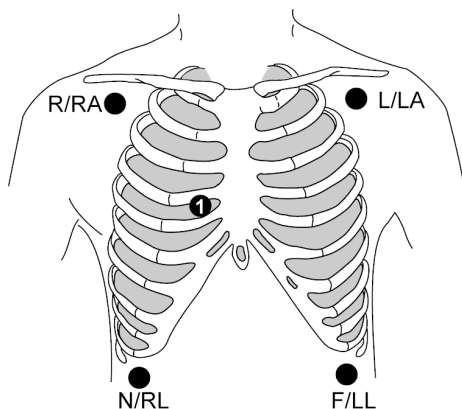

IEC	AAMI/AHA	Electrode placement
R (red)	RA (white)	Just below the right clavicle.
L (yellow)	LA (black)	Just below the left clavicle.
User defined	User defined	For the 5-lead placement, place the precordial electrode according to the physician's preference.
N (black)	RL (green)	Lower right edge of the rib cage.
F (green)	LL (red)	Lower left edge of the rib cage.

6-lead ECG electrode placement

NOTE PDM and PSM only.

NOTE For 12RL monitoring, a 12RL 12 lead ECG license is required.

NOTE

A 6- or 10-leadwire cable may be used. However, when using a 10-leadwire cable, do not prepare or connect precordial leads 2, 3, 4, or 6. Position the Ca/Va electrode in the C1/V1 position and place the Cb/Vb electrode in the C5/V5 position. The leadwire label for the Ca/Va and Cb/Vb leads are white (IEC) or brown (AAMI/AHA).

If you are using the 6-leadwire cables for a 12 lead ECG connection, note that the 12RL can be used for adult patients only.

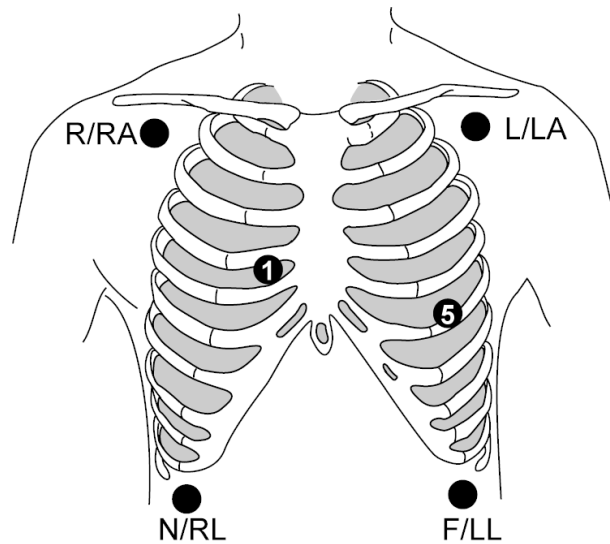

IEC	AAMI/AHA	Electrode placement
R (red)	RA (white)	Just below the right clavicle.
L (yellow)	LA (black)	Just below the left clavicle.
Ca/C1 (white)	Va/V1 (brown)	4 th intercostal space, right sternal border.
Cb/C5 (white)	Vb/V5 (brown)	Left anterior axillary line at C4/V4 level.
N (black)	RL (green)	Lower right edge of the rib cage.
F (green)	LL (red)	Lower left edge of the rib cage.

10-lead ECG electrode placement for cardiac monitoring

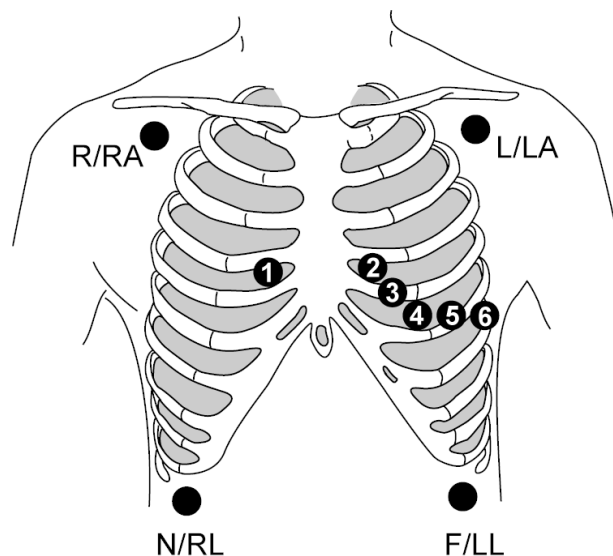

IEC	AAMI/AHA	Electrode placement
R (red)	RA (white)	Just below the right clavicle.
L (yellow)	LA (black)	Just below the left clavicle.
N (black)	RL (green)	Lower right edge of the rib cage.
F (green)	LL (red)	Lower left edge of the rib cage.
C/C1 (white)	V/V1 (brown)	4 th intercostal space, right sternal border.
C2 (white/yellow)	V2 (brown/yellow)	4 th intercostal space, left sternal border.
C3 (white/green)	V3 (brown/green)	Midway between C2/V2 and C4/V4.
C4 (white/brown)	V4 (brown/blue)	5 th intercostal space, mid-clavicular line.
C5 (white/black)	V5 (brown/orange)	Left anterior axillary line at C4/V4 level.
C6 (white/purple)	V6 (brown/purple)	Mid-axillary line at C4/V4 and C5/V5 levels.

Standard resting 10-lead ECG electrode placement

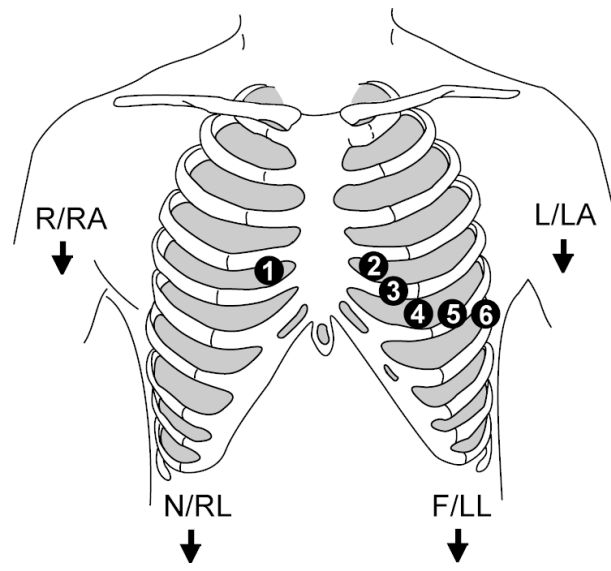

IEC	AAMI/AHA	Electrode placement
R (red)	RA (white)	Right deltoid or wrist.
L (yellow)	LA (black)	Left deltoid or wrist.
N (black)	RL (green)	Right thigh or ankle.
F (green)	LL (red)	Left thigh or ankle.
C/C1 (white)	V/V1 (brown)	4 th intercostal space, right border of the sternum.
C2 (white/yellow)	V2 (brown/yellow)	4 th intercostal space, left border of the sternum.
C3 (white/green)	V3 (brown/green)	Midway between C2/V2 and C4/V4.
C4 (white/brown)	V4 (brown/blue)	5 th intercostal space, mid-clavicular line.
C5 (white/black)	V5 (brown/orange)	Left anterior axillary line at C4/V4 level.
C6 (white/purple)	V6 (brown/purple)	Mid-axillary line at C4/V4 and C5/V5 levels.

Checking the ECG measurement

1. Check that the waveforms and parameter values are displayed when the cable is connected to the patient.

About the ECG analog output signal

Maximum delay of the ECG analog output signal is 30 ms with the PDM and 15 ms with E-modules. Pacemaker pulse indication is included when appropriate and it is summed in to the ECG waveform.

ECG synchronization pulse delay from the R-wave peak is <35 ms for the PDM and E-modules, with the exception of wide QRS (120 ms/0.5 mV).

For more information and detailed specifications, refer to the supplemental information manual.

ECG module	Analog output signal
E-modules	ECG 1 Lead (top waveform position). If ECG 1 Lead is any of the derived leads related to the 12RL 12 lead, then the analog output will use lead II.
PDM	ECG 1 Lead (top waveform position).
TRAM	ECG 1 Lead (top trace position).
Tram-Rac	Lead II is the first ECG lead for analog output. ECG 1 Lead is the second ECG lead for analog output. Va is the third ECG lead for analog output.

About the combination monitoring mode

The combination monitoring is a licensed feature. In combination monitoring mode ECG is acquired from a telemetry receiver system. This ECG data acquisition capability enhances basic telemetry monitoring by providing access to all of the available parameters from bedside monitors, while acquiring the ECG data from telemetry. In this monitoring mode, all data — local and telemetry — is viewed at the central station and the bedside monitor. However, any historical data stored at the central station will be unavailable. Any new alarm history samples created on the telemetry transmitter cannot be viewed on the monitor if they are created after the combination monitoring has been started. Only the snapshots created on the monitor and the samples of the telemetry transmitter created prior to starting the combination monitoring can be viewed.

The combination monitoring mode can be enabled through **Monitor Setup > Default Setup > Care Unit Settings > Telemetry > Monitor or Telemetry**, and the setting is password protected. The monitor needs to be configured to the CARESCAPE Network. This option cannot be used in the NICU software package.

In case the telemetry patient has been admitted when the device is connected to the monitor, the arrhythmia alarm priorities and limit alarm priorities (except in case the monitor alarm is set to escalating) and the following ECG settings of the telemetry will be used:

- HR, ST, and PVC alarm limits
- PVC alarm status (on/off)
- Pacemaker detection
- Lead analysis
- Va lead position
- Primary lead
- ECG waveform size
- Arrhythmia detection level
- ST analysis status (on/off)

When combination monitoring is started with a non-admitted telemetry patient, these same settings from the monitor will be sent to telemetry. Additionally, the **Telemetry Waveforms** printing location is sent to telemetry.

If the telemetry alarm priority is such that it is not supported by the monitor, it will be mapped to the next higher priority available.

NOTE Patient's age affects the alarm limits and alarm priorities and also the configuration of the ECG algorithm including arrhythmia alarms in the combination monitoring mode. For more information, see the ApexPro Telemetry System Operator's Manual.

When combination monitoring is started with a non-admitted telemetry patient, the printout type selection will be sent to the telemetry transmitter.

CAUTION Users should be aware that all waveforms may be delayed up to 2 seconds in the combination monitoring mode. If the delay needs to be avoided, the combination monitoring mode should be discontinued and all waveforms should be acquired via the hard-wired bedside monitor.

CAUTION Users should be aware of a possible time discrepancy between the waveforms from the telemetry device and the waveforms from a device hard-wired to the monitor. Users should not consider these waveforms to be synchronous. If absolute synchronicity is desired, the combination monitoring mode should be discontinued and the ECG waveforms should be acquired via the hard-wired bedside monitor.

Selecting the ECG source

NOTE Not available with the NICU software package.

This setting is available if the telemetry license is enabled and the combination monitoring mode **Monitor or Telemetry** has been enabled during configuration. The monitor needs to be in the CARESCAPE Network.

1. Select the HR parameter window.
2. Select a source from the **ECG Source** list.

This list contains the monitor and available telemetry transmitter(s). When you confirm the source selection with **Confirm**, the connection between the selected transmitter and monitor will be established (telemetry transmitter selected), or the patient is discharged from the telemetry transmitter (monitor selected).

Using the ECG measurement

The first three displayed ECG leads

You can choose the order of the ECG waveforms displayed in the ECG waveform area.

Lead selection depends on the type of ECG cable used.

The **ECG 1 Lead**, **ECG 2 Lead**, and **ECG 3 Lead** settings affect arrhythmia detection.

When **ECG 1 Lead**, **ECG 2 Lead**, or **ECG 3 Lead** are changed manually and the lead becomes inactive due to a disconnection, the monitor looks to the ECG lead saved in the patient profile. If **ECG 1 Lead** is not available, the monitor looks for lead II, then lead I, and lastly lead III. Later, if the manually selected lead becomes available again, the monitor will change back to this lead.

Selecting the first displayed ECG lead

The **ECG 1 Lead** is the first ECG lead displayed in the ECG waveform area. The monitor uses the **ECG 1 Lead** for single-lead analysis if it is I, II, III, or V1. If it is anything else, then the following mapping is used: V2 to V6 = V1, aVR = II, aVL = I, aVF = III.

1. Select the HR parameter window.
2. Select a lead from the **ECG 1 Lead** list.

Selecting the second displayed ECG lead

The **ECG 2 Lead** is the ECG lead displayed after the **ECG 1 Lead** in the ECG waveform area.

1. Select the HR parameter window.
2. Select a lead from the **ECG 2 Lead** list.

If your selection is **Cascade**, the displayed **ECG 1 Lead** waveform continues into the **ECG 2 Lead** waveform area.

Selecting the third displayed ECG lead

The **ECG 3 Lead** is the ECG lead displayed after the **ECG 2 Lead** in the ECG waveform area.

1. Select the HR parameter window.
2. Select a lead from the **ECG 3 Lead** list.

If your selection is **Cascade**, the displayed **ECG 2 Lead** waveform continues into the **ECG 3 Lead** waveform area.

Selecting the Va ECG lead

NOTE 12RL monitoring - The Va lead is the first V-lead label used with a 6-leadwire ECG cable for 12RL monitoring. 12RL is possible only if the Va is set to V1.

The **Va Lead Position** selection affects the ST numeric trends.

When using a 6-leadwire ECG cable, the factory default for the Va lead is V1, however you may choose a different lead.

The Va lead is the only V-lead used with a 5-leadwire ECG cable.

The Va lead is the V-lead data that is sent to all remote devices like the central station.

1. Select the HR parameter window.
2. Select a lead from the **Va Lead Position** list.

Combination monitoring and Va/Vb lead selections with 6-lead cable

NOTE It is recommended to use the default settings for the Va and Vb lead position selections with a 6-lead cable in combination monitoring mode. If you do not use the default settings, do not use the same settings for **Va Lead Position** and **Vb Lead Position**. Otherwise the Va value will display the ST measurement value measured from the Vb lead.

Selecting the Vb ECG lead

NOTE PDM and E-modules only.

NOTE 12RL monitoring - The Vb lead is the second V-lead label used with a 6-leadwire ECG cable for 12RL monitoring and must be set to **V5**.

This selection is not available with combination monitoring.

When using a 6-leadwire ECG cable, the factory default for the Vb lead is V5, however you may choose a different lead.

1. Select the HR parameter window.
2. Select a lead from the **Vb Lead Position** list.

Changing to an ECG cable with fewer leadwires

This selection will update the measurement mode between 3-, 5-, 6-, 12RL and 10-lead mode when changing to a smaller amount of leadwires with PDM, TRAM, and E-modules. Transition from the 12RL mode to the 6-lead mode is detected automatically.

This selection is not available with combination monitoring.

1. Select the HR parameter window.
2. Select **Update Lead Set**.

Deactivating the ECG leads off alarm

The selection is available when there are not enough leads connected for arrhythmia detection. This selection will acknowledge the **ECG Leads Off** alarm, but it will not change the measurement mode to fewer leads.

This selection is not available with combination monitoring.

1. Select the HR parameter window.
2. Select **Deactivate ECG Leads Off**.

Selecting the beat source

Not all sources (like telemetry ECG, TRAM IP) provide the necessary status information for this.

1. Select the HR parameter window.
2. Select the beat source from the **Beat Source** list:
 - **Primary HR**
 - **ECG**
 - **Art**
 - **ABP**
 - **Fem**
 - **UAC** (NICU software package only)
 - **Pleth**

The beat source indicator  will appear beside the chosen beat source on the screen, and the beat sound will reflect the beat of that source.

Setting the beat volume

1. Select the HR parameter window.
2. Set the beat tone volume with the **Beat Volume** arrows.

The range is 0 (volume off) to 10. The louder the volume, the more bars in the indicator.

Setting the beep tone during bradycardia and HR low alarms

NOTE PDM and TRAM only. NICU software package only.

This selection is not available with combination monitoring.

This selection is available if the **Beat Volume** for QRS is set to 0 (off).

If the alarm for bradycardia has been set to off or silenced, or the ECG alarms are silenced permanently, then the QRS tone does not sound, either.

1. Select the HR parameter window.
2. Set the beep tone: **Beat Tone on Brady Only** > **On** or **Off**.

When the beep tone is selected **On**, the QRS tones will sound only with **Brady** alarm conditions.

- If the alarm volume has been set to below 8, the QRS tones will sound at the selected alarm volume level +2.
- If the alarm volume has been set to 8 or more, the QRS tones will sound at alarm volume level 10.

Variable beat tone

You can configure a variable beat tone through **Monitor Setup** > **Default Setup** > **Care Unit Settings** > **Parameters** > **Variable Beat Tone**. This setting is password protected.

If it set to **All beat sources**, the SpO₂ saturation affects all beep sounds including ECG and IP when the SpO₂ measurement is available: beep frequency changes according to increasing and decreasing SpO₂ values. If the setting is set to **Only SpO₂**, other beep sounds are not affected by the changing SpO₂ values.

For more information, see the supplemental information manual.

Aspect ratio and different display sizes

ECG aspect ratio is the ratio of the vertical sensitivity (ECG size) to the horizontal sensitivity (sweep speed).

The BB650 aspect ratio is optimized for the 15" integrated display. If larger external displays are used, the waveform size and sweep speed may change.

The B850 aspect ratio is optimized for a 19" display. If a display of a different size is used, the waveform size and sweep speed may change.

For more information, see the supplemental information manual.

Selecting the ECG waveform size

This selection adjusts the size of the displayed ECG waveform.

1. Select the HR parameter window.
2. Select a value from the **ECG Size** list.

The selections are **0.5x**, **1x**, **2x**, **4x**. The smaller the value, the smaller the waveform.

NOTE The **ECG Size** setting affects arrhythmia detection and heart rate calculation sensitivity. Normal waveform size/QRS detection sensitivity is **1x**. Size **2x** and greater increases the QRS detection sensitivity. This may be helpful for low amplitude QRS waveforms. Use with caution since baseline artifact may be detected as a QRS complex.

Selecting the hemodynamic waveform sweep speed

NOTE This setting adjusts the waveform speed for all of the hemodynamic parameters.

1. Select the HR parameter window.
2. Select a numeric value from the **Hemodynamic Sweep Speed** list.

The smaller the value, the slower the sweep speed.

Printing all ECG waveforms

NOTE Pressing Graph in the telemetry transmitter will start the telemetry waveform printing.

1. Select the HR parameter window.
2. Select **All ECG Waveforms**.
3. Select **Print Page**.
4. You can stop printing by selecting **Stop Printing** or **Cancel Printing**.

Selecting the ECG waveform filter

You can select how the waveform appears on the display and on the printout.

1. Select the HR parameter window.
2. Select the **Advanced** tab.
3. Select a filter from the **Waveform Filter** list. Choices are:
 - **Diagnostic:**
 - TRAM: 0.05 to 100 Hz.
 - ◆ TRAM with a 10-leadwire cable: The waveform filter is automatically set to **Diagnostic** and cannot be changed.
 - E-modules and PDM: 0.05 Hz to 150 Hz.
 - **Monitoring:**
 - PDM, E-modules, TRAM: 0.05 Hz to 32 Hz (with 50 Hz powerline frequency).
 - PDM, E-modules, TRAM: 0.05 Hz to 40 Hz (with 60 Hz powerline frequency).

- Telemetry transmitters: 0.05 Hz to 40 Hz. The waveform filter is automatically set to **Monitoring** and cannot be changed.
- **Moderate:**
 - PDM, E-modules, TRAM: 0.05 Hz to 25 Hz.
- **Maximum:**
 - PDM, E-modules, TRAM: 5 Hz to 25 Hz.

When the **Maximum** filter is selected, the prompt text **Warning: Maximum filter alters the displayed ECG morphology** is displayed.

Setting the QRS width

NOTE This setting affects the arrhythmia detection sensitivity.

This selection is not available with combination monitoring.

If the **QRS Width** is locked in the **Care Unit Settings**, the option is not selectable.

1. Select the HR parameter window.
2. Select the **Advanced** tab.
3. Select a setting from the **QRS Width** list. Choices are:
 - **Narrow:** Intended for use with all neonates and the pediatric patient with a QRS complex width of 100 ms or less. This is the default setting for the **Infant** and **Pediatric** profiles.
 - **Normal:** Intended for ECG rhythms that have QRS complex widths of approximately 70 ms or wider (for example, almost all adult patients and any patient with electronic ventricular pacing).

Selecting the leads for ECG analysis

You can choose whether the monitor performs an ECG analysis using single lead ECG data or data from multiple ECG leads. Multiple ECG leads will typically reduce false alarms and improve the detection sensitivity. However, if most leads are noisy or low amplitude, the **Single lead** mode using the best available ECG lead will help.

With a 3-leadwire cable the setting is **Single lead** and cannot be changed. If the measurement mode is changed from the 3-leadwire mode to 5-, 6-, 10-lead or 12RL mode, the setting changes to **Multi lead**.

1. Select the HR parameter window.
2. Select the **Advanced** tab.
3. Select an option from the **Lead Analysis** list. The choices are:
 - **Single lead:** EkPro algorithm uses one of the leads I, II, III, or V1 for the analysis. **ECG 1 Lead** is used for the analysis if it is I, II, III, or V1. If it is anything else, then the following mapping is used: V2 to V6 = V1, aVR = II, aVL = I, aVF = III. Also note that the ST values are only calculated for the single lead.
 - **Multi lead:** EkPro algorithm uses the following leads:
 - 3-lead mode: the only measured lead (I, II, or III)
 - 5-lead and 6-lead mode: any lead assigned to Va.
 - 12RL mode: I, II, III, and V1.
 - 12-lead mode: I, II, III, and V1.

Relearning the patient's QRS pattern

During ECG monitoring, you may need to use the **Relearn QRS** feature when a dramatic change in the patient's ECG pattern has occurred. Allowing the monitor to learn the new ECG pattern corrects false arrhythmia alarms and heart rate values, and restores the ST measurements. Relearning takes typically 30 seconds or less. The message **Relearning...** displays while the monitor relearns the QRS pattern. During this time, arrhythmia detection may not be available. If the monitor is not able to relearn due to a low amplitude QRS, for example, the **Arrhythmia paused** alarm is triggered.

1. Select the HR parameter window.
2. Select the **Advanced** tab.
3. Select **Relearn QRS**.

Automatic relearning takes place when:

- The measurement mode changes between the 3-lead mode and any other lead mode.
- The **ECG 1 Lead** selection is changed in the 3-lead mode.
- The Va lead selection is changed in the 5- and 6-lead modes.
- The ECG cable is connected (PSM, PDM).
- The **Lead Analysis** setting is changed from **Multi lead** to **Single lead**.

Setting the primary HR source

The primary heart rate can be calculated from the ECG leads, SpO₂ measurement, or invasive pressure waveform.

NOTE This setting adjusts the primary heart rate source for all of the hemodynamic parameters.

1. Select the HR parameter window.
2. Select the **Advanced** tab.
3. Select a parameter from the **Primary HR Source** list. The selection list will only show active measurements and **AUTO** or **IntelliRate**. Choices are (**UAC** with the NICU software package only):
 - PDM with single HR: **IntelliRate, ECG, Art, ABP, Fem, UAC, Pleth**.
 - PDM with multiple HR: **IntelliRate, ECG**.
 - E-modules, TRAM, telemetry transmitters with single HR: **AUTO, ECG, Art, ABP, Fem, UAC, Pleth**.
 - E-modules, TRAM, telemetry transmitters with multiple HR: **AUTO, ECG**.

Showing a second HR value in the HR parameter window

You can display a second heart rate source in the HR parameter window.

1. Select the HR parameter window.
2. Select the **Advanced** tab.
3. Select the **Show 2nd HR Source** check box to display the second HR source.
 - If the primary HR source for E-modules is **ECG** or **AUTO** (ECG), the secondary HR source is displayed in this order: **Art, ABP, Fem, SpO₂**.

- If the primary HR source for PDM is **ECG** or **IntelliRate** (ECG), or **AUTO** (ECG) for TRAM, the secondary HR source displayed in this order: **UAC, Art, ABP, Fem, SpO2**. **UAC** is available in the NICU software package only.
- If the primary HR source is anything else than mentioned above, the secondary HR source is always **ECG**.

Showing ST in the HR parameter window

This option is available with the Multi-lead ST Analysis license only.

1. Select the HR parameter window.
2. Select the **Advanced** tab.
3. Select the **Show ST** check box to display ST in the HR parameter window.

Showing PVC in the HR parameter window

This option is enabled with the full arrhythmia license and the **Full** detection level only.

1. Select the HR parameter window.
2. Select the **Advanced** tab.
3. Select the **Show PVC** check box to display PVC in the HR parameter window.

Showing QT in the HR parameter window

This option is available with the Multi-lead QT/QTc Analysis license only.

This selection is not available with combination monitoring.

1. Select the HR parameter window.
2. Select the **Advanced** tab.
3. Select the **Show QT** check box to display QT in the HR parameter window.

Displaying the ECG grid

You can have a reference grid in the **ECG1**, **ECG2**, and **ECG3** waveform areas. The grid points will be at 200 ms horizontally and 0.5 mV vertically.

1. Select the HR parameter window.
2. Select the **Advanced** tab.
3. Select the **ECG Grid** check box to display the grid.

ECG alarm limits

The **HR Alarms** can be set to **Single** or **Multiple** through **Monitor Setup > Default Setup > Care Unit Settings > Parameters > ECG**. This setting is password protected.

The **Single** heart rate setting allows you to set one common HR limit for multiple sources (e.g., ECG, SpO₂, Art) and the PVC and SVC alarm limits for ECG from the **Alarms** tab. With this setting activated, turning off the SpO₂ HR alarm limits also turns off the primary HR alarm and adjusting the SpO₂ HR limit values also adjusts the primary HR limit value.

The **Multiple** heart rate setting allows you to set a primary heart rate/pulse rate source and up to six individual heart rate/pulse rate alarms and limits from the **HR/PR Alarms**

tab. It also allows you to set PVC and SVC alarm limits for ECG from the **PVC/SVC Alarms** tab. (The tab is called **PVC Alarms** with TRAM or telemetry transmitters). With the **Multiple** heart rate setting activated, turning off the SpO₂ HR alarm limits does not turn off the primary HR alarm.

Setting HR alarm limits for a single HR source

1. Select the HR parameter window.
2. Select the **Alarms** tab.
3. Check that the required alarm, **HR**, **PVC**, or **SVC**, is turned on.
If a feature is not active, the alarm limits are greyed out.
4. Select **Alarm On** to set the alarms.
5. Adjust the alarm limits with the arrows.

Setting HR/PR alarm limits for multiple HR sources

1. Select the HR parameter window.
2. Select the **HR/PR Alarms** tab.
3. Check that the required alarm is turned on.
If a feature is not active, the alarm limits are greyed out and the **Alarm On** check box is not selected.
4. Select the **Alarm On** check box for those alarms you wish to set.
5. Adjust the alarm limits with the arrows.

Setting PVC alarm limits

Available with the full arrhythmia license only.

1. Select the HR parameter window.
2. Select the **PVC/SVC Alarms** or **PVC Alarms** (TRAM or telemetry transmitters) tab. If the heart rate setting is **Single**, select the **Alarms** tab.
3. Check that the **PVC** alarm is turned on.
If a feature is not active, the alarm limits are greyed out.
4. Select **Alarm On** to set the alarms.
5. Adjust the alarm limits with the arrows.

Setting SVC alarm limits

Available with the full arrhythmia license only. Not available with combination monitoring or TRAM.

1. Select the HR parameter window.
2. Select the **PVC/SVC Alarms** tab. If the heart rate setting is **Single**, select the **Alarms** tab.
3. Check that the **SVC** alarm is turned on.
If a feature is not active, the alarm limits are greyed out.
4. Select **Alarm On** to set the alarms.

- Adjust the alarm limits with the arrows.

Selecting the HR alarm range

With the **Single** heart rate setting only.

- Select the HR parameter window.
- Select the heart rate alarm range from the **HR Alarm Range** list:
 - 30–240** (set and disabled if the **Primary HR Source** is **IntelliRate**, **AUTO**, or **SpO2**).
 - 20–300**

NOTE

France only: Available selections are **30–230** and **20–230**. Selection **30–230** is set and disabled if the **Primary HR Source** is **IntelliRate**, **AUTO**, or **SpO2**.

ECG alarm priorities

You can set the alarm priorities for various ECG alarms through **Alarm Setup > Alarm Priorities > ECG**. The allowed priorities are defined in the **Care Unit Settings**, and they are password protected.

ECG measurement practicalities

Alternate pulse rate source

The alternate pulse rate source allows clinicians to acquire a pulse rate from a source other than ECG (Art, Fem, ABP, UAC, or SpO₂). The following circumstances may warrant the use of an alternate pulse rate source:

- Excessive artifact due to an electrical interference from equipment (e.g., electrosurgical device).
- Excessive patient movement causing significant artifact (e.g., seizure activity).
- Inability to use standard lead placement (e.g., burns).

PDM IntelliRate algorithm

The PDM uses the **IntelliRate** algorithm. **IntelliRate** extracts information from multiple physiological signals (ECG, SpO₂, Art) and applies rule-based logic to determine which heart rate source has the highest likelihood of being accurate. By reporting the most accurate rate, the trended pulse rate is more accurate, and occurrences of false pulse rate limit violation alarms are greatly reduced. The alternate pulse rate source value replaces the standard heart rate value in the HR parameter window.

TRAM, E-modules, and telemetry transmitters Auto algorithm

TRAM, E-modules, and telemetry transmitters use the **AUTO** algorithm. **AUTO** selects the first available heart rate source based on a pre-defined parameter priority:

- ECG
- UAC (TRAM and NICU software package only)

3. Art
4. ABP
5. Fem
6. SpO₂

ECG troubleshooting

Problem	Solution
ECG signal is noisy or no QRS is detected	<ul style="list-style-type: none"> • Ensure that the patient is not shivering. • Select the correct filter by selecting the HR parameter window > Advanced > Waveform Filter. • Check the electrode quality and positioning. Do not place electrodes on body hair, bones close to skin, layers of fat and major muscles. Pre-gelled electrodes are recommended. • Change the lead in ECG1 to the best available signal and consider using the Single lead mode. • Consider using ECG Size > 2x. • Try an alternative location for the Va lead to improve signal quality. In some cases, like if the patient has a significant heart failure, changing for example from V5 to V1 can result in a considerable difference in the signal amplitude. • Check all cable connectors.

12 lead analysis

Intended use of 12RL Interpolated 12 lead ECG analysis

The GE 12RL program generates a 12 lead ECG report from a subset of the electrodes used to acquire a standard 12 lead ECG. Four of the precordial channels of the 12 lead ECG (V2, V3, V4, V6) are not acquired from the patient; rather, they are reconstructed from information that is directly recorded in the other channels of the 12 lead ECG.

The four signals generated by the GE 12RL program are similar but not identical to the standard 12 lead ECG. All ECG data generated via 12RL are clearly identified as to which channels have been synthesized.

The GE 12RL program is intended for use in a monitoring environment. Computerized measurements may be generated from these data; however, a computerized interpretation will not.

The product is intended for use in the general adult population ranging from healthy subjects to patients with cardiac and/or non-cardiac abnormalities.

The product is to be used in conjunction with the patient's clinical history, symptoms, and other diagnostic tests for final clinical judgment.

Intended use of 12SL ECG analysis

The 12SL Analysis Program assists the physician in measuring and interpreting resting 12 lead ECGs for rhythm and contour information by providing an initial automated interpretation. Interpretation by the product is then confirmed, edited, or deleted by the physician. The analysis program is intended for use in the general population, ranging from healthy subjects to patients with cardiac and/or non-cardiac abnormalities. The analysis is intended for use in hospitals, outpatient clinics, emergency departments, and out-of-hospital sites such as ambulances and patients' homes.

ACS Tool option is intended for adult patient population who are suspected clinically to have acute coronary syndrome.

NOTE Although the 12SL analysis program can be used out-of-hospital, CARESCAPE monitors are intended for in-hospital use only.

The 12SL analysis program is also referred to as the 12 lead ECG analysis program.

Intended use of ACI-TIPI

The Acute Cardiac Ischemia–Time Insensitive Predictive Instrument (ACI-TIPI) is intended to be used in a hospital or clinic environment by competent health professionals. TIPI utilizes recorded ECG data along with patient demographic and chest pain status to produce a numerical score which is the predicted probability of acute cardiac ischemia. Like any computer-assisted ECG interpretation program, the GE Marquette ACI-TIPI evaluation and probability score is intended to supplement, not substitute for the physician's decision process. It should be used in conjunction with knowledge of the patient's history, the results of a physical examination, the ECG tracing, and other clinical findings.

ACI-TIPI is intended for adult patient populations.

12 lead ECG analysis points to note

- For a 12 lead ECG analysis, a 12SL ECG with ACI-TIPI license, 10-leadwire cable, and 10-lead lead electrode placement are required.
- To obtain the most accurate 12 lead ECG analysis, you should enter accurate patient demographics. This is especially important when storing and comparing 12 lead reports in the MUSE database.
- For a 12 lead ECG analysis with the 12RL feature, a 12RL 12 lead ECG license and a 6-leadwire cable (or a 10-leadwire cable with the C2/V2, C3/V3, C4/V4, and C6/V6 leads disconnected) is required.
- For a 12 lead ECG analysis with the 12RL feature, confirm that the Va and Vb lead positions are set correctly for a 12RL measurement.
- For the most accurate serial comparisons, use the same electrode configuration as used on the prior analysis for the patient.
- 12RL measurement data is not sent to the S/5 Network.

Entering data for a 12 lead ECG analysis

When the **Tech ID Required** is set to mandatory in the **Care Unit Settings**, you must enter the **Technician ID** before you can confirm the 12 lead settings. All **Care Unit Settings** are password protected.

For more information, see the supplemental information manual.

1. Select the HR parameter window.
2. Select **12 Lead Analysis**.
3. Select **Settings**.
4. Enter the **Technician ID** if required.
5. Enter the **Order Number**.
6. Select an option from the **Reasons for 12 Lead** list.

You can also add your own password protected list of pre-defined reasons for recording a 12 lead ECG through the **Care Unit Settings**.

7. Select **Cancel** or **Confirm**.

Entering data for an ACI-TIPI 12 lead ECG analysis

NOTE The patient must be at least 16 years old for an ACI-TIPI 12 lead ECG analysis.

1. Select the HR parameter window.
2. Select **12 Lead Analysis**.
3. Select **Settings**.
4. Select **On** from the **ACI - TIPI** list.
5. Select the patient's gender from the **Gender** list.
This selection will also be updated to the patient demographics.
6. If the patient's age has not been entered previously, select it now from the **Age** list.
7. Select the symptoms present from the **Chest or Left Arm Pain** list.
8. Select **Cancel** or **Confirm**.

Selecting **Confirm** is required before you can complete an ACI-TIPI 12 lead ECG analysis.

Enabling and disabling the 12SL ACS

WARNING Acute Coronary Syndrome (ACS) feature must be used only with patients to whom this measurement is suitable.

12SL-ACS is an optional higher-sensitivity analysis for the detection of acute ischemia and acute infarction designed for a higher risk population with a higher prior probability of having these conditions. When this setting is enabled, you will get ACS-specific statements in addition to the diagnostic statements.

1. Select the HR parameter window.
2. Select **12 Lead Analysis**.
3. Select **Settings**.
4. Select **On** or **Off** from the **ACS** list.
5. Select **Cancel** or **Confirm**.

Entering the *Location ID* for 12SL

If roving between units is allowed and the 12SL ECG with ACI TIPI is enabled, you can enter the ***Location ID*** that will be used in the 12SL reports.

1. Select the patient information area on screen.
2. Select the ***Care Unit & Bed*** tab.
3. Select the ***Location ID*** field and enter the ID with the on-screen numeric keypad. You can enter any number from 0 to 599.

Setting automatic 12 lead ECG analysis measurements

1. Select the HR parameter window.
2. Select ***12 Lead Analysis***.
3. Select ***Settings***.
4. Select a time interval from the ***Auto Interval*** list.
5. Select ***Cancel*** or ***Confirm***.

Setting the 12 lead ECG analysis display format

This setting will change the 12 lead ECG waveform display format and the printed 12 lead ECG report waveform format.

1. Select the HR parameter window.
2. Select ***12 Lead Analysis***.
3. Select ***Settings***.
4. Select a format from the ***Display Format*** list:
 - ***4 x 2.5 - 1 Rhythm***
 - ***4 x 2.5 - 3 Rhythms***
 - ***12 Rhythms***
 - ***Cabrera***
5. Select ***Cancel*** or ***Confirm***.

Generating a 12 lead ECG analysis report during an ST alarm condition

You can have a 12 lead ECG report automatically generated when an ST alarm condition occurs. Automatically generated reports are viewable through ***12 Lead Analysis > Saved Reports***.

1. Select the HR parameter window.
2. Select ***12 Lead Analysis***.
3. Select ***Settings***.
4. Select ***On*** from the ***12 Lead on ST Alarm*** list.
5. Select ***Cancel*** or ***Confirm***.

Performing a 12 lead ECG analysis

1. Select the HR parameter window.
2. Select **12 Lead Analysis**.
3. Select **12 Lead Now**.

All the waveforms in the **12 Lead Analysis** view freeze during the analysis except for the ECG I waveform. Analysis takes less than one second to complete. At that time, the monitor generates a 12 lead report, saves the report locally, and displays the report on the screen. The monitor can store up to fifteen 12 lead reports locally.

A 12 lead report and the MUSE database

After the monitor generates the 12 lead report, you can send it to the optional MUSE database for further analysis or storage, print the report, or delete the report.

The **Send to MUSE** or **MUSE + Print** are not selectable when:

- The MUSE database is not available or when the local report has already been sent to the MUSE database.
- A temporary medical record number is used and **Care Unit Settings > Transmit with temp MRN** has not been enabled.
- The 12RL feature was used. The MUSE database does not support a 12 lead report with the 12RL feature.
- The monitor is connected to the S/5 Network.

Sending a 12 lead ECG report to the MUSE database

1. Select the HR parameter window.
2. Select **12 Lead Analysis**.
3. Select **Send to MUSE**.
The local 12 lead ECG report is now sent to the MUSE database.
4. Select **Print** to print the 12 lead report.
You can also select **MUSE + Print** instead of the two separate steps 3 and 4 above.
5. Select **Delete** to delete the report and return to the real-time view.
6. To generate a new 12 lead ECG analysis report, select **Real-time View** and repeat the procedure for performing a 12 lead ECG analysis.

Viewing or printing saved 12 lead ECG reports

You can view and print 12 lead reports that are stored at the monitor (local), or if available, stored at a MUSE database. The newest reports are displayed first.

To open a report that is stored at the MUSE database, a connection to the CARESCAPE Network is required.

1. Select the HR parameter window.
2. Select **12 Lead Analysis**.
3. Select **Saved Reports**.
4. Select the desired 12 lead report from the list.

- To view this report, select **View**.

A report that is stored locally at the monitor opens and displays in the **12 Lead Analysis** view. A report that is stored at the MUSE database opens and displays in the **MUSE Report** view.

- To send a locally saved 12 lead ECG report to the MUSE database, select **Send to MUSE**.

You can only send the report to the MUSE database once.

- To resize a report displayed in the **MUSE Report** view, select a value from the **Zoom** list.

If you zoom in closer on the report, use the vertical scroll bar to view all parts of the report.

- To print a report displayed in the **MUSE Report** view, select **Print**.

- To stop printing, select **Stop Printing** or **Cancel Printing**.

About the 12 lead ECG analysis program

The 12 lead ECG analysis program assists the physician in interpreting and measuring the resting ten seconds of ECG data. This program generates a diagnostic textual report on patient's cardiovascular condition. This report can be routed to the MUSE Cardiology Information System via the CARESCAPE Network. The following figure shows a typical 12 lead ECG report.



- Patient information, including patient **Name**:, **MRN**:, **Date**: and **Time**: the report was generated.
- Available values including **Ventricular Rate**, **PR Interval**, **QRS Duration**, **QT/QTc**, and **P-R-T Axis**.
- Diagnostic statements and/or error messages.
- Waveform area.

Up to 15 reports can be stored on the monitor until the patient is discharged. Also a PDF report generated by the MUSE can be viewed via the monitor.

The 12 lead ECG analysis program includes the Gender Specific Criteria and the Acute Cardiac Ischemia-Time Insensitive Predictive Instrument (ACI-TIPI). ACI-TIPI uses recorded ECG data to produce a numerical score which is the predicted probability of acute cardiac ischemia. In addition, the gender specific criteria improves the detection

of acute myocardial infarctions (AMI) for adult women under the age of 60. ACI-TIPI can be enabled or disabled for the admitted patient.

Complete analysis requires a 10-leadwire cable.

About the 12RL ECG analysis program

- NOTE** 12RL is not available with the NICU software package.
- NOTE** Reconstructed (interpolated) leads cannot be selected for pacemaker detection or impedance respiration monitoring.
- NOTE** Interpretive statements are not available when a 12 lead ECG analysis is generated using the 12RL analysis program.

The 12RL analysis program generates a 12 lead ECG report from a subset of the electrodes used to acquire a standard 12 lead ECG. The 12 lead report includes the statement **LEADS V2, V3, V4, AND V6 ARE INTERPOLATED** to identify that the ECG measurements were analyzed using reconstructed (interpolated) leads. If the software version of the MUSE does not support this message, the message **STATEMENT NOT FOUND** is displayed instead. Reconstructed leads are identified on the monitor and in printouts (graphs) by the letter d (for derived) before the lead name (e.g., dV2) to ensure the clinician can identify the reconstructed waveform tracings.

12RL uses a standard 6-leadwire electrode placement to acquire leads I, II, III, AVR, AVF, V1 and V5. The four precordial leads (V2, V3, V4, V6) are not acquired from the patient. This reconstruction assumes accurate electrode placement and typical anatomy.

For 12RL monitoring, a 6- or 10-leadwire cable may be used. However, when using a 10-leadwire cable, do not prepare or connect precordial leads 2, 3, 4, or 6.

12 lead ECG analysis troubleshooting

Problem	Solution
Transmitting a 12 lead report to a MUSE database fails.	There are communications problems with the network or the MUSE database. <ul style="list-style-type: none"> Contact authorized service personnel.
Printing a 12 lead analysis report fails.	There is a printer error or communication problems with the network. <ul style="list-style-type: none"> Check the printer. If you cannot resolve the problem, contact authorized service personnel.

Pacemaker detection

Pacemaker detection warnings

- WARNING** — RATE METERS — Keep pacemaker patients under close observation. Rate meters may continue to count the pacemaker rate during cardiac arrest and some arrhythmias. Therefore, do not rely entirely on rate meter alarms. See the supplemental information manual for disclosure of the pacemaker pulse rejection capability of this device.

- WARNING** — FALSE CALLS — False low heart rate indicators or false Asystole calls may result with certain pacemakers because of pacemaker artifact such as electrical overshoot of the pacemaker overlapping the true QRS complexes.
- WARNING** — MONITORING PACEMAKER PATIENTS — PDM, TRAM, and telemetry: the monitoring of pacemaker patients can only occur with the pace program activated.
- WARNING** — PACEMAKER INDICATION — Pacemaker activity is indicated on the electrocardiogram through the display of a different colored pacemaker marker pulse. All pacemaker marker pulses appear upright and uniform and should not be used for diagnostic interpretation.
- WARNING** — PATIENT HAZARD — A pacemaker pulse can be counted as a QRS during Asystole when pacemaker detection is on. Keep pacemaker patients under close observation.
- WARNING** — PATIENT HAZARD — Asystole may not be detected if the patient has a pacemaker that produces high-amplitude pacer spikes, the pacemaker detection is on, and a PDM is used. Keep pacemaker patients under close observation.

Pacemaker detection points to note

- PDM, TRAM, combination monitoring: Pacemaker detection must be turned on at the monitor. It must be used whenever the monitored patient has a pacemaker.
- E-modules: Pacemaker detection is always on.
- E-modules: If the patient has an atrial pacemaker, ST calculations can be performed if the pacer spike does not coincide with the ISO point's adjustment range.

Selecting the pacemaker detection

With E-modules the pacemaker detection is always enabled.

With PDM, TRAM, and combination monitoring it must be turned on. However, you may disable pacemaker event processing by turning off pacemaker detection. When pacemaker detection is turned off, the monitoring device ignores pacemaker pulse detections which may adversely affect the heart rate accuracy of the monitoring device.

1. Select the HR parameter window.
2. Select the **Advanced** tab.
3. Select a value from the **Pacemaker Detection** list.

List options are acquisition module dependent:

- E-modules:
 - **Show**: Displays pacemaker spikes on the ECG waveform.
 - **Hide**: Hides the pacemaker spikes on the ECG waveform.
 - **Sensitive**: Increases pacemaker detection sensitivity and displays the pacemaker spikes on the ECG waveform. By selecting this option you can improve the detection of small amplitude pacemakers. However, this mode is also more sensitive to false pacemaker detections.

- PDM:
 - **On:** Turns on pacemaker detection.
 - **Off:** Turns off pacemaker detection.
- TRAM, combination monitoring:
 - **Off:** Turns off pacemaker detection.
 - **Pace 2:** Minimizes the possibility of counting pacemaker artifact as QRS complexes during asystole.
 - **Pace 1:** Does not minimize the possibility of counting artifact as a QRS complex during asystole. If the monitor resets or is discharged, or the profile is changed, and the monitor is set to **Pace 1**, the monitor automatically changes to the **Pace 2** setting.

NOTE

TRAM version 12 or later and telemetry with ApexPro 4.1 or later with enhanced pacemaker detection will automatically detect pacemakers with either **Pace 1** or **Pace 2**. Selecting one or the other makes no difference in this respect.

Pacemaker detection troubleshooting

Problem	Solution
How does activating pacemaker detection impact monitoring?	<ul style="list-style-type: none"> • Beats that would otherwise be classified as ventricular are instead classified as V-paced if a ventricular pacemaker event is detected. • Residual pacemaker energy that might otherwise appear in the ECG is removed, and a pacemaker enhanced spike is placed in the ECG. • On the ECG waveform, pacemaker detection is indicated by uniform, upright pacemaker enhancement spikes in the ECG data, both displayed and graphed.
How can pacemaker detection be improved?	<ul style="list-style-type: none"> • Possible problems include: <ul style="list-style-type: none"> ▪ Heart rate double counting. ▪ Inaccurate alarms for low heart rate or asystole. ▪ Pacemaker spikes not recognized by the software. ▪ False PVC detections and arrhythmia alarms. • Possible solutions include: <ul style="list-style-type: none"> ▪ Relearn arrhythmia. ▪ Re-prepare the patient skin, replace the electrodes, and adjust the electrode placement. ▪ Try an alternate electrode placement. ▪ Try single-lead analysis, if available.

Problem	Solution
	<ul style="list-style-type: none"> ▪ E-modules, TRAM, combination monitoring: Switch to another pacemaker detection mode.
<p>Why is the monitor double-counting the heart rate, alarming for a low heart rate, or not detecting pacemaker spikes?</p>	<p>The monitor is not detecting pacemaker activity. Causes may include:</p> <ul style="list-style-type: none"> • PDM, TRAM, combination monitoring: The pacemaker detection program is turned off. Turn it on, reprep the skin and reposition the electrodes if necessary. Relearn ECG. • The pacemaker signal is too weak for the monitor to detect. • The ECG signal is too weak for the monitor to detect. • The monitor is detecting atrial pacemaker artifact or non-QRS features as beats. <p>If the monitor is alarming for low heart rate or asystole, assess the QRS amplitude:</p> <ul style="list-style-type: none"> • View all ECG leads to assess the amplitude of the QRS complexes. To ensure correct HR readings, a 0.5 mV QRS amplitude is recommended for a normal ECG signal. If the QRS amplitude drops below 0.5 mV or an abnormal QRS width occurs (more than 120 ms), QRS detection may be reduced, leading to false asystole alarms. • If necessary, reprep the skin and reposition the electrodes. • Relearn ECG.

Arrhythmia monitoring

Arrhythmia monitoring warnings

WARNING

V Fib/V Tach should not be considered a substitute for the V Tach arrhythmia alarm. Efforts to lower the V Tach alarm level can result in missed ventricular tachycardia alarms.

WARNING

— LOSS OR DETERIORATION OF ARRHYTHMIA DETECTION — Automated arrhythmia analysis programs may incorrectly identify the presence or absence of an arrhythmia. A physician must therefore interpret the arrhythmia information in conjunction with other clinical findings. Please take special note of the following ECG waveform conditions:

- Noisy waveforms. Noisy portions of ECG waveforms are typically excluded from analysis. The exclusions are necessary to reduce the occurrence of inaccurate beat interpretations and/or rhythm alarms. If the excluded noisy portions of the ECG waveform contain true arrhythmia events, those events may remain undetected by the system.

- Beat amplitude and duration. Accurate detection and interpretation of beats becomes increasingly difficult as the amplitude and/or duration of those beats approach the design limits of the analysis program. Thus, as beats become extremely wide or narrow, or especially as beats become small, arrhythmia interpretation performance may degrade.
- Other morphology considerations. Automated arrhythmia detection algorithms are designed fundamentally to detect significant changes in QRS morphology. If an arrhythmia event is present and does not exhibit a significant change from the patient's predominant morphology, it is possible for those events to remain undetected by the system.

WARNING — PAUSED ANALYSIS — Certain conditions pause arrhythmia analysis. When paused, arrhythmia conditions are not detected and alarms associated with arrhythmias do not occur. Conditions causing paused arrhythmia analysis include arrhythmia off, arrhythmia paused, leads fail, alarm pause, all alarms off, and discharged patient.

WARNING — FAILURE TO DETECT LETHAL ARRHYTHMIA — Always monitor ECG for arrhythmia detection purposes. HR calculated from pulsatile SpO₂ waveform may differ significantly from ECG HR measured values. Users should be aware that the **SpO2 probe off** and **No SpO2 pulse** technical alarms escalate no higher than a **Medium** priority.

WARNING — FAILURE TO DETECT LETHAL ARRHYTHMIA — The SpO₂ parameter pulsatile heart rate measurement is based on the optical detection of a peripheral flow pulse and therefore may not detect certain arrhythmias. The pulse oximetry parameter should not be used as a replacement or substitute for ECG based arrhythmia analysis.

WARNING — ARRHYTHMIA PAUSED alarm — The **Arrhythmia paused** alarm indicates that the system is no longer monitoring arrhythmia or heart rate from ECG. If you adjust the alarm priority level lower than the default value, keep the patient under close surveillance.

Arrhythmia measurement limitations

- Since the arrhythmia detection algorithm sensitivity and specificity is less than 100%, sometimes there may be some false arrhythmias detected and also some true arrhythmia events may not be detected. This is especially true when the signal is noisy.
- The ECG size and QRS width settings affect arrhythmia detection and heart rate calculation sensitivity.
- If QRS amplitude is low, the monitor might not be able to calculate HR and false Asystole may occur.
- During the learning phase of the algorithm, arrhythmia detection may not be available. As a result, the patient condition should be closely monitored during the learning phase and for several minutes after the learning phase to allow the algorithm to reach optimal detection performance.

- Not all ECG acquisition devices recognize the same set of arrhythmias. For example, telemetry monitoring devices and TRAM do not recognize **SV Tachy**, **Multifocal PVCs**, and **Missing beat**, but these will be recognized by devices like PDM and PSM. Additional arrhythmia recognition may be added in future versions of monitoring devices. Because remote devices like central stations may not be aware of all arrhythmias recognized by acquisition devices, the monitoring devices rename some arrhythmias when they are sent to the network. Monitoring devices rename the following arrhythmias when sending them to the network:

Shown on the monitor	Shown at remote devices like central stations
SV Tachy	Tachy
Frequent SVCs	Irregular
Multifocal PVCs	PVC
Missing beat	Pause

Setting the arrhythmia category to alarm

Depending on what has been allowed in the **Care Unit Settings > Parameters > ECG > Allowed Arrh. Levels**, you can select different arrhythmia categories to alarm.

1. Select the HR parameter window.
2. Select the **Arrhythmia** tab.
3. Select **Lethal Alarms**.
4. Select the arrhythmia category you want to alarm:
 - **Full**: All arrhythmias alarm.
 - **Lethal**: Only lethal arrhythmias alarm.
 - **Off**: No arrhythmia alarms are generated.

Combination monitoring and arrhythmia alarm categories

NOTE

Always select **Full** or **Lethal** arrhythmia categories to alarm in the combination monitoring mode. If you discharge a telemetry patient on the monitor and then change their arrhythmia alarm category at the central station, make sure that the arrhythmia priorities are as clinically expected.

Setting arrhythmia alarms

While monitoring ECG, you can adjust the settings for arrhythmia alarm conditions.

1. Select the HR parameter window.
2. Select the **Arrhythmia** tab.
3. Select **Lethal Alarms**, **Ventricular Alarms**, or **Atrial Alarms**.
Ventricular Alarms and **Atrial Alarms** are only adjustable with the full arrhythmia license.
4. Select an arrhythmia from the list.
5. Select the arrhythmia alarm's **Alarm Priority** with the arrows.

6. Select the check box for **Create Snapshot** if you wish to activate an arrhythmia snapshot creation.
7. Select the check box for **Print on Alarm** if you wish to activate printing during arrhythmia alarm.

For arrhythmia alarm waveform printing, the printing will continue until 20 seconds has passed from the clearance of the last active arrhythmia alarm (e.g., 10 seconds saved data, arrhythmia alarm duration + 20 seconds data).

Setting the alarm pause interval

With TRAM or combination monitoring this setting is always 3 seconds and cannot be edited.

You can set the time interval between the two adjacent beats before the pause alarm condition is annunciated.

1. Select the HR parameter window.
2. Select the **Arrhythmia** tab.
3. Select **Atrial Alarms**.
4. Select a value from the **Pause Interval** list.

Setting the SVT length

E-modules and PDM only.

This setting determines how many consecutive SVCs are needed to trigger the **SV Tachy** alarm.

1. Select the HR parameter window.
2. Select the **Arrhythmia** tab.
3. Select **Atrial Alarms**.
4. Select a value from the **SVT Length** list.

Setting HR for SVT

E-modules and PDM only.

This setting determines the minimum value for the HR to trigger the **SV Tachy** alarm.

1. Select the HR parameter window.
2. Select the **Arrhythmia** tab.
3. Select **Atrial Alarms**.
4. Select a value from the **HR for SVT /min** list.

Arrhythmia alarm messages

NOTE

A clinician must analyze the arrhythmia information in conjunction with the other clinical findings.

Alarm message	Arrhythmia analysis	Alarm priority default	Arrhythmia detection criteria
A Fib	Full (All other software packages except NICU; not available with TRAM)	According to priority setting	Absence of P-waves and irregular RR-interval.
Accel. Ventric.	Full	According to priority setting	Accelerated ventricular rhythm - Run of PVCs with a run length of at least six beats and the rate requirements have not met for V Tach or V Brady .
Asystole	Lethal	High	HR decreased to zero.
Bigeminy	Full	According to priority setting	Every other beat is PVC (N-V-N-V-N-V).
Brady	Lethal with NICU software package Full with all other software packages TRAM and combination monitoring only	According to priority setting	Displayed 4/8-beat average ECG heart rate falls below the user-selected common HR low limit or ECG HR low limit.
Couplet	Full	According to priority setting	Two consecutive PVCs are detected between normal beats, N-V-V-N. The coupling interval between the PVCs must be less than 600 ms.
Irregular	Full PDM in NICU software package only, TRAM with all software packages	According to priority setting	Six consecutive normal RR intervals vary by 100 ms or more.
Missing beat	Full E-modules with all software packages; PDM with other software packages except NICU	According to priority setting	Actual RR interval more than 1.8 times the average RR interval.
Multifocal PVCs	Full E-modules, PDM	According to priority setting	Over the last 15 beats two or more PVCs with different morphologies are detected.
Pause	Full	According to priority setting	Coupling interval between two beats exceeds: <ul style="list-style-type: none"> • 3 seconds with TRAM and combination monitoring • 1 to 5 seconds (configurable) with E-modules and PDM

Alarm message	Arrhythmia analysis	Alarm priority default	Arrhythmia detection criteria
<i>R on T</i>	<i>Full</i>	According to priority setting	Isolated PVC is detected within 100 ms of the peak of the T-wave of the patient's predominant normal beat.
<i>Single PVC</i>	<i>Full</i> TRAM or combination monitoring only.	According to priority setting	Isolated PVC is detected.
<i>SV Tachy</i>	<i>Full</i> E-modules and PDM only	According to priority setting	A run of SVCs is detected with a run length of at least the set SVT Length and the heart rate is at least the set HR for SVT /min.
<i>Tachy</i>	<i>Full</i> TRAM or combination monitoring only.	According to priority setting	Occurs when four consecutive RR intervals or the displayed 4/8-beat average ECG heart rate exceeds the user-selected common HR high limit or ECG HR high limit.
<i>Trigeminy</i>	<i>Full</i>	According to priority setting	Every third beat is PVC (N, N, V, N, N, V, N, N, V).
<i>V Brady</i>	<i>Full</i>	According to priority setting	Run of PVCs are detected with a run length of at least three beats. In addition, at least two consecutive RR intervals in the run must have an effective heart rate less than 50 bpm (OR, PACU, ICU, ED) or 60 bpm (NICU).
<i>V Fib/V Tach</i>	<i>Lethal</i>	High	ECG waveform indicates a chaotic ventricular rhythm.
<i>V Tach</i>	<i>Lethal</i>	According to priority setting. Always High if V Tach duration >30 seconds, and HR >180 bpm in NICU or >150 bpm in other software packages, and HR is over the user adjusted HR high limit.	OR, PACU, ICU, and ED software packages: A run of PVCs is detected with a run length of six beats or more and the effective HR exceeds 100 bpm. NICU software package: A run of PVCs is detected with a run length of six beats or more and the

Alarm message	Arrhythmia analysis	Alarm priority default	Arrhythmia detection criteria
			effective HR exceeds 160 bpm.
<i>VT>2</i>	<i>Full</i>	According to priority setting	A run of PVCs is detected with a run length of more than two beats but less than the six beats. In addition at least two consecutive RR intervals in the run must have an effective HR that exceeds 100 bpm.

About the arrhythmia detection

When an ECG signal is detected at the start of monitoring, the arrhythmia detection algorithm begins acquiring and analyzing QRS complexes in the leads used for arrhythmia detection. This phase is known as learning. Once learning is complete, the dominant QRS complex is stored as a reference template. Reference template is used as a normal morphology of that patient and it is compared with incoming beats to identify possible arrhythmias.

The EK-Pro arrhythmia detection algorithm is used. EK-Pro simultaneously analyzes leads I, II, III, and V. Once learning is complete, the dominant QRS complex becomes the template. When a PDM with an ongoing ECG measurement is connected, the system shall provide the EK-Pro V11 arrhythmia detection from the PDM until the monitor's EK-Pro v13 algorithm has learned the ECG rhythm and starts to provide the arrhythmia detection.

The algorithm uses continuous correlation, incremental template updating and contextual analysis. Continuous correlation attempts to find the best match between each incoming complex and the set of stored (learned) templates. If no match is found with the existing template, a new template is stored for the identified new QRS shape. Incremental template updating allows information from each beat, that correlates over time, to be reflected in the associated template. Contextual analysis uses information from neighboring QRS complexes along with existing template measurements to make the best possible decision regarding the beat's origin (e.g., early, wide).

Arrhythmia troubleshooting

Problem	Solution
Why is the monitor alarming for asystole, bradycardia, pause, or inaccurate heart rate when a visible QRS waveform is present?	<p>The monitor may not be detecting sufficient QRS amplitude in all analyzed leads. Multiple leads are used for arrhythmia processing.</p> <ol style="list-style-type: none"> 1. Assess the patient. 2. Check the ECG signal acquired from the patient. 3. View all ECG leads to assess the amplitude of the QRS complexes. To ensure correct HR readings, a 0.5 mV QRS amplitude is recommended for a normal ECG signal. If the QRS amplitude drops below 0.5 mV or an abnormal QRS width occurs

Problem	Solution
	<p>(more than 120 ms), QRS detection may be reduced, leading to false Asystole alarms.</p> <ol style="list-style-type: none"> 4. Relearn arrhythmia. It is important to relearn the patient's ECG pattern any time the electrode configuration is adjusted. 5. The ECG size settings affect the arrhythmia detection and heart rate calculation. Increase the ECG size by selecting a value from the ECG Size list. <p>If the problem continues, switch to the ECG lead with the greatest amplitude, display that lead, then switch to single lead analysis so all arrhythmia interpretations are based on this single ECG lead.</p>
<p>How does the IntelliRate algorithm impact an Asystole alarm with a QRS waveform?</p>	<p>Intellirate will report Asystole when the following conditions are met:</p> <ul style="list-style-type: none"> • The ECG HR has been valid and has changed by 1/min or less during the previous 30 seconds . • The invasive pressure pulse rate has been valid for the previous 60 seconds, and it has been 0/min during the previous 30 seconds. • The mean arterial blood pressure of the invasive pressure pulse rate source is below the user-selected limit. • The SpO₂ parameter if available does not indicate beat detections in the previous 30 seconds.
<p>Why is the monitor calling V Tach when the patient is not in V Tach?</p>	<p>The monitoring system may be detecting a wider QRS complex or artifact in some of the analyzed ECG waveforms. In addition, the V leads may be exhibiting polarity changes, which may occasionally cause an inaccurate call.</p> <ol style="list-style-type: none"> 1. Assess the patient. 2. Check the ECG signal acquired from the patient. <ul style="list-style-type: none"> • View all ECG leads to assess the width of the QRS complexes in the analyzed leads. • If artifact exists in any of the analyzed leads, reprep the patient's skin, replace electrodes, and adjust the electrode placement. • It may be beneficial to move V lead electrodes (chest lead) to alternate precordial electrode placements to improve detection. 3. Relearn arrhythmia. It is important to relearn the patient's ECG pattern any time the electrode configuration is adjusted. <p>If the problem continues, determine the lead with the narrowest QRS complex, display that lead, then switch to single lead analysis so all arrhythmia interpretations are based on this single ECG lead.</p>

ST detection

About the ST analysis

NOTE Multi-lead ST Analysis license only.

If enabled, ST analysis starts automatically after the ECG leads have been connected and QRS detection has started. The message **Learning** displays within each QRS complex window. Once the program has completed the learning phase, ST values are updated every 10 seconds, QRS complexes every 40 seconds.

ST detection with PDM and E-modules

During the learning period, the algorithm uses the isoelectric reference and the J+ reference points to calculate the ST values. The algorithm automatically searches for the J and ISO points. These settings can be adjusted for the current patient.

ST detection with TRAM

During the learning period, the algorithm uses the isoelectric reference and the J+ reference points to calculate the ST values. Once the learning is complete, the dominant QRS complex becomes the template for ST segment analysis. The algorithm uses continuous correlation and incremental template updating. Continuous correlation attempts to find the best match between each incoming complex and the set of stored (learned) templates. Incremental template updating allows information from each beat, that correlates over time, to be reflected in the associated template.

ST detection measurement limitations

- ST values may be affected by such factors as some drugs or metabolic and conduction disturbances.
- Since ST is often calculated with a fixed delay from the J point, changes in heart rate may affect ST.
- The ST algorithm has been tested for accuracy of the ST segment data. The significance of the ST segment changes needs to be determined by a physician.

ST detection points to note

- TRAM: When the TRAM has stored ST data, and is then connected to the monitor, a new reference QRS is saved to the monitor at the time of connection. The reference QRS from the TRAM cannot be used because the reference QRS does not have time stamp.
- ST segment deviations are not displayed for patients with ventricular pacemakers or if the rhythm is considered as from ventricular origin.

Starting the ST detection

1. Select the ST parameter window or select the HR parameter window and the **ST** tab.
2. Select **Setup**.
3. Select **On** from the **ST Analysis** list.

Selecting leads to the ST window

1. Select the ST parameter window.
2. Select **Setup**.
3. Select the leads for display from the **ST Window** list.

Choices are:

- **ST Leads:** Displays the first three ST leads. The ST lead with the greatest deviation is also displayed in the parameter window to the right of the ST leads.
- **All Leads:** Displays anterior, inferior, and lateral lead groups.
- **Off:** No ST parameter window is displayed. Instead, two ECG waveforms are displayed beside the HR field (if **ECG2** has been selected to the screen).

Changing the displayed ST leads

You can select the display order of the first, second, and third displayed ST lead.

1. Select the ST parameter window.
2. Select **Setup**.
3. Select a lead from the **ST Leads** list.

Adjusting the ST point manually

This selection is not available with combination monitoring.

- E-modules and PDM automatically set the ST point according to the heart rate. Manual adjustments may be required if the following automatic settings are not adequate for example when QT time is short:
 - If the heart rate is greater than or equal to 120 bpm, then the ST point is set to J + 60 ms.
 - If the heart rate is less than 120 bpm, then the ST point is set to J + 80 ms.
- TRAM modules set the ST point automatically according to the profile default. Manual adjustments may be required if the default is not adequate.

Manually adjusting the **ST Point**, **ISO Point**, or **J Point** overrides the automatic detection of the ST point. As a result, you are responsible for monitoring the patient ST levels with new adjustments and required to make further setting adjustments as necessary according to changes in the patient's rhythm.

1. Select the ST parameter window.
2. Select **Setup**.
3. Select a value from the **ST Point** list.

Adjusting the isoelectric measurement (ISO) point

This selection is not available with TRAM or combination monitoring.

E-modules and PDM automatically set the isoelectric point. Manual adjustments may be required if, for example, a P-wave is attached to the QRS-wave.

1. Select the ST parameter window.
2. Select **Setup**.

3. Adjust the **ISO Point** with the arrows.

When the **ISO Point** is adjusted, also the ST point changes accordingly and its automatic setting is stopped.

Adjusting the J point

This selection is not available with TRAM or combination monitoring.

1. Select the ST parameter window.
2. Select **Setup**.
3. Adjust the **J Point** with the arrows.

When the **J Point** is adjusted, also the ST point changes accordingly.

About the realtime QRS/ST complexes

This feature is not available with TRAM or combination monitoring.

The initial reference QRS is stored and used as a comparison against the incoming QRS complexes. The current complex is superimposed over the reference complex in order to visually assess the change in each QRS complex. QRS complexes are updated every 40 seconds with PDM and every 10 seconds with E-modules. Current ST values in millimeters shall be displayed in each QRS window. Numeric values are updated every 10 seconds.

About the reference QRS

TRAM modules save the initial reference QRS after 64 beats have been detected. With TRAM one reference QRS complex can be stored manually.

PDM and E-modules save the initial reference QRS up to three minutes after the ECG measurement is started. With PDM or E-modules up to six additional reference QRS complexes can be stored manually.

Each QRS reference is identified with the date and timestamp.

If a new reference QRS complex is saved and there is no room for another reference complex, then the oldest manual or automatic reference complex is erased.

Saving a reference QRS manually

This selection is not available with combination monitoring.

You cannot save a reference QRS manually until an initial reference QRS complex has been saved, or if ST Analysis is disabled.

1. Select the ST parameter window.
2. Select **Realtime View**.
3. Select **Save Reference**.

The current QRS becomes the new reference QRS.

Automatic saving of reference QRS complexes

The QRS reference is not saved during an ST alarm condition, only the ST snapshot is saved.

If a new reference QRS complex is saved and there is no room for another complex, then the oldest manual or automatic complex is erased. You may want to manually erase QRS complexes to avoid automated erasing.

A reference QRS complex is saved automatically whenever you do one of the following:

- Change the Va or Vb lead.
- Change the ST point manually.

Selecting a saved reference QRS complex for display

This selection is not available with combination monitoring or TRAM.

You can select and display a saved reference QRS for ST analysis.

1. Select the ST parameter window.
2. Select **Realtime View**.
3. Select a saved reference from the **Reference QRS** list.

Erasing a reference QRS

This selection is not available with combination monitoring or TRAM.

You cannot erase the initial reference QRS.

1. Select the ST parameter window.
2. Select **Realtime View**.
3. Select a reference QRS from the **Erase Reference** list.

If you delete the reference QRS currently displayed, then the next, newer reference QRS is displayed as the reference QRS.

Printing a realtime QRS/ST report

This selection is not available with combination monitoring.

The QRS/ST report displays the current ST leads and the trends at 10 minute intervals.

1. Select the ST parameter window.
2. Select **Realtime View**.
3. Select **Print QRS/ST**.
4. To stop printing, select **Cancel Printing**.

Viewing QRS and ST in a split screen

In the split screen window, you can view the reference QRS complex, current QRS complexes, and ST trends.

1. Select **Monitor Setup** from the monitor's main menu.
2. Select **Screen Setup**.
3. Select **Split Screen**
4. Select **ST** to view an ST/QRS split screen.

Selecting the ST time scale

This selection is not available with combination monitoring.

This setting also determines the length of the ST trend report, and you can select it from the **Realtime View** or the **Trend View**.

1. Select the ST parameter window.
2. Select **Realtime View** or **Trend View**.
3. Select a value from the **Trend Scales** list.

ST trend display

This feature is not available with combination monitoring.

Each QRS window displays the current QRS complex and ST value. The QRS complexes and current measurement point lines are updated at least every 40 seconds. Each QRS window has a corresponding trend window displaying the ST trend along with the trend scale and current time interval. The primary HR trend window is displayed below the last ST trend window. The ST trends for the available leads are updated every 10 seconds.

Displaying QRS complexes and ST trends for other leads

This selection is not available with combination monitoring.

1. Select the ST parameter window.
2. Select **Trend View**.
3. Select a lead group from the **Leads** list. Choices are:
 - **ST**: The leads displayed in the ST window.
 - **Anterior**: The leads belonging to this lead group.
 - **Inferior**: The leads belonging to this lead group.
 - **Lateral**: The leads belonging to this lead group.
 - **Display**: The leads associated with the waveforms selected for display.

Reviewing ST trends

This selection is not available with combination monitoring.

You can review ST trend values and compare ST trend related QRS complexes with realtime QRS complexes by using the yellow-colored cursor. The current time of the cursor is displayed above the cursor. Each yellow-colored trend value is displayed next to the cursor and ST trend related QRS complexes are drawn in the QRS windows with the color gray.

1. Select the ST parameter window.
2. Select **Trend View**.
3. Select the right or left arrow above the QRS view to move the ST cursor.

Printing an ST trend report

This selection is not available with combination monitoring.

The length of the ST trend report is the same as the **Trend Scales** setting for ST trends.

1. Select the ST parameter window.
2. Select **Trend View**.
3. Select **Print Page**.
4. To stop printing, select **Cancel Printing**.

Ischemic burden

This feature is not available with combination monitoring.

Ischemic burden provides additional information about the degree of ST changes during a certain time period. It is a visualization of ischemia. In ST Trend View, the area between the ST trend and the ischemic burden limit is colored yellow:

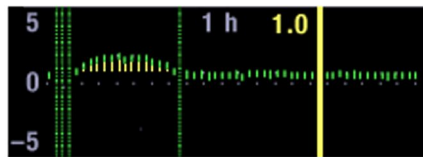

Myocardial ischemia appears in the ECG as an ST segment deviation from the isoelectric line (ISO point). The ST segment generally rises above the isoelectric line in the presence of transmural ischemia and is below the isoelectric line in the presence of subendocardial ischemia. The ST measurements are displayed as a numeric value: a negative (-) number indicates ST depression; a positive (+) number indicates ST elevation.



ST depression



ST elevation

Enabling ischemic burden

This selection is not available with combination monitoring.

1. Select the ST parameter window.
2. Select **Trend View**.
3. Select **Ischemic Burden**.
4. Select the check box for **Ischemic Burden**.

Setting the ischemic burden limits

This selection is not available with combination monitoring.

You can set the lower and upper threshold values.

1. Select the ST parameter window.
2. Select **Trend View**.
3. Select **Ischemic Burden**.
4. Set the lower threshold value with the **Depression Limit (mm)** arrows.
5. Set the upper threshold value with the **Elevation Limit (mm)** arrows.

ST alarm limits

Depending on what has been selected in the **Care Unit Settings** for ST alarms, you may set the ST alarm limits for a lead group, for individual leads, or for all leads relative to the patient's current measurements.

The leads associated with each lead group are as follows:

- Anterior: V1, V2/dV2, V3/dV3, V4/dV4.
- Inferior: II, III, aVF.
- Lateral: V5, V6/dV6, I, aVL.

The d in dV2, dV3, dV4, and dV6 above represents the derived lead value.

Setting alarm limits for lead groups

1. Select the ST parameter window.
2. Select **Alarms**.
3. Select **Alarm On** for an ECG lead group: **Anterior**, **Inferior**, or **Lateral**.
If the alarm is locked, there is a lock symbol beside the selection and the selection is not available.
4. Set upper and lower alarm limits with the arrows.

Setting alarm limits for individual leads

1. Select the ST parameter window.
2. Select **Alarms**.
3. Select **Alarm On** for an ECG lead to adjust its alarm limits.
If the alarm is locked, there is a lock symbol beside the check box and the selection is not available.
4. Set **High** and **Low** alarm limits with the arrows.

Setting relative alarm limits

You can adjust the high/low alarm limits set around the current ST value for all of the individual ST leads or for the leads in a selected lead group. For example, when you select a **Relative Auto Limits** value of 2 mm, the high limit is set at the current ST value +2 mm, and the low limit is set at the current ST value -2mm.

1. Select the ST parameter window.
2. Select **Alarms**.
3. Select **Relative Auto Limits**.
4. Set the relative limits as needed:
 - Set **All Limits** with the arrows and select **Update All**.
 - Set limits for **Anterior** leads with the arrows and select **Update Anterior**.
 - Set limits for **Inferior** leads with the arrows and select **Update Inferior**.
 - Set limits for **Lateral** leads with the arrows and select **Update Lateral**.

QT detection

This selection is not available with combination monitoring or TRAM.

With Multi-lead QT/QTc Analysis license only.

The administration of some drug types can prolong the QT segment. Monitoring QT segment changes can help identify how these drugs are affecting the QT segment.

QT/QTc measurement limitations

- Not available with combination monitoring or TRAM.
- At least one measured V-lead must be available in order for the algorithm to process QT.
- QT/QTc values are calculated with 5-leadwire, 6-leadwire, or 10-leadwire ECG cables.

Starting the QT/QTc measurement

This selection is not available with combination monitoring or TRAM.

1. Select the HR parameter window.
2. Select the **QT** tab.
3. Select **On** from the **QT Analysis** list.

Setting QT/QTc alarms

This selection is not available with combination monitoring or TRAM.

1. Select the HR parameter window.
2. Select the **QT** tab.
3. Select **Alarms**.
4. Select **Alarm On**.
5. Adjust the alarm limits with the arrows.

Selecting QT or QTc for analysis

This selection is not available with combination monitoring or TRAM.

1. Select the HR parameter window.
2. Select the **QT** tab.
3. Select **QT** or **QTc** from the **Show** list.

Impedance respiration

Impedance respiration compatibility limitations

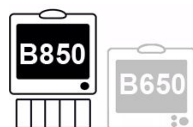

TRAM and Tram-Rac modules with the B850 only.

For detailed information regarding module, monitor, and accessory compatibility, see the supplemental information manual.

Respiration safety precautions

Respiration warnings

- WARNING** Make sure that the leadwire set clips or snaps do not touch any electrically conductive material including earth.
- WARNING** The impedance respiration measurement is inherently very sensitive as it measures very small physiological signals (changes of impedance of the patient's chest area). Electromagnetic interference may cause erroneous measurements at various frequencies, for example interference with the signal/ waveform, leading to respiration rate readings inconsistent with the patient's true respiration rate. If you notice this, use another form of respiration monitoring, for instance end-tidal CO₂.
- WARNING** When using an electrosurgery unit, note that the measurement cables do not incorporate means to protect against burns in case of a defective ESU return electrode. To avoid burns at the monitor measurement sites, ensure the following:
- Proper contact of the ESU return electrode to the patient.
 - ESU return electrode near the operating area.
 - Measurement electrodes, leadwires and probes far from the surgical site and the ESU return electrode.
- WARNING** — APNEA EVENTS — The monitor may not detect all episodes of inadequate breathing, nor does it distinguish between central, obstructive, and mixed apnea events.

- WARNING** — DEFIBRILLATOR PRECAUTIONS — Patient signal inputs labeled with the CF and BF symbols with paddles are protected against damage resulting from defibrillation voltages. To ensure proper defibrillator protection, use only the recommended cables and leadwires.
- WARNING** — ELECTRODE CONFIGURATION — Impedance respiration monitoring is not reliable when ECG electrodes are placed anywhere but on the chest.
- WARNING** — ELECTRODES — Whenever patient defibrillation is a possibility, use non-polarizing (silver/silver chloride construction) electrodes for ECG monitoring. Polarizing electrodes (stainless steel or silver constructed) may cause the electrodes to retain a residual charge after defibrillation. A residual charge will block acquisition of the ECG signal.
- WARNING** — PDM and TRAM — If the **Cardiac Artifact Alarm** is turned off, apnea events may not be detected.

Respiration cautions

- CAUTION** The impedance respiration measurement may cause rate changes in Minute Ventilation Rate Responsive Pacemakers. Set the pacemaker rate responsive mode off (PDM and TRAM only) or turn off the impedance respiration measurement on the monitor.

Respiration measurement limitations

- PSM: Impedance respiration is intended for patients over three years old.
- Electrical devices, such as electrosurgery units and infrared heaters, that emit electromagnetic disturbance, may cause artifacts or disable the respiration measurement completely.
- Movement artifacts, shivering, and interference from the heart may interfere with the respiration measurement.

Respiration points to note

- Connect only one impedance respiration module to the monitor simultaneously.
- Do not place electrodes on obvious layers of fat, or major muscles.
- Make sure the electrode gel is moist.
- Make sure electrodes have good skin contact.
- Depending on the respiration module used, not all respiration measurements and settings are available to view or change.
- Since respiration monitoring is so closely linked with ECG monitoring, patient preparation and electrode placement are important.
- Intermittent mechanical ventilation: During spontaneous breathing the ventilator may at times support the patient's ventilation with an extra inspiration. If these ventilator inspirations are substantially larger than the spontaneous breaths, the respiration calculation may mistakenly count only the inspirations and expirations produced by the ventilator.

Respiration measurement setup

Respiration equipment to patient connection

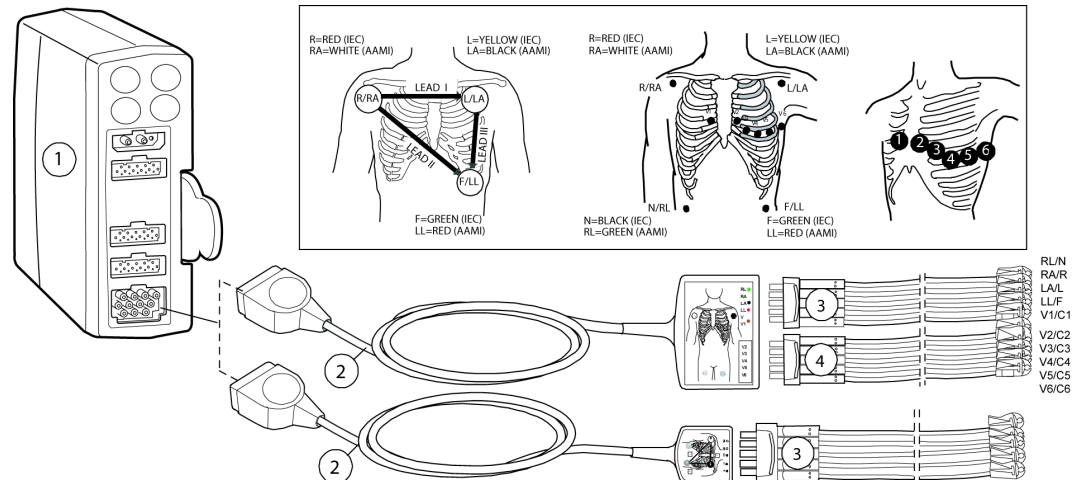

1. Module with ECG measurement capability
2. AAMI/AHA or IEC Multi-Link 3/5-lead, 6-lead, or 12SL ECG cable
3. AAMI/AHA or IEC 3-leadwire, 5-leadwire, or 6-leadwire set
4. AAMI/AHA or IEC precordial leads leadwire set

Preparing the patient's respiration electrode sites

Excessive body hair or skin oil reduces electrode contact with the skin and decreases the quality of electrode signal.

When preparing the electrode sites, avoid obvious layers of fat and major muscles.

1. Shave any hair from the electrode site.
2. Gently rub the surface of the skin to increase capillary blood flow.
3. Clean the skin with alcohol or a mild soap and water solution to remove skin oil and dead or abraded skin cells.
4. Dry the skin completely before applying the electrodes.

Respiration lead and breath detection

Respiration leads identify the ECG leads used for respiration measurement. Each respiration lead is suited for specific breath detection conditions:

Lead	Description	Available with modules
Lead I	Best for detecting thoracic breathing, but is more susceptible to cardiogenic artifact.	TRAM, PDM, PSM
Lead II	Equally good at detecting thoracic or abdominal breathing, but is more susceptible to cardiogenic and motion (head, neck, or arm) artifact.	TRAM, PDM, PSM PSM uses the ECG lead selection if the measurement mode is 3-lead and Lead II if the measurement mode is 5-, 6-, or 10-leadwire set. If any electrode is disconnected, the remaining lead (I, II or III) is used, if possible.
Lead RL-LL	Best at detecting abdominal breathing and is not as susceptible to cardiogenic or motion artifact. The RL-LL respiration lead is available with PDM only.	PDM Not available for 3-lead measurement.

If you are monitoring with a fixed-lead, 3-lead cable, respiration can only be obtained from the lead for which the cable is manufactured. For example, if the cable is a fixed lead II cable, as indicated by a label on the cable itself, respiration can only be obtained from lead II.

PDM and TRAM: Even though the same electrodes are used for ECG and respiration monitoring, it is possible to get a lead fail message for respiration without one for ECG. The impedance may be too high for respiration detection, but the electrode is still good for ECG.

Respiration lead I electrode placement

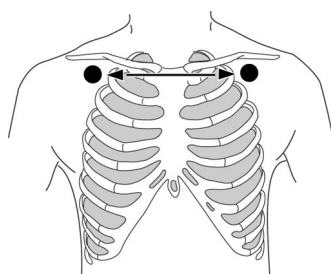

ECG lead I for upper chest breather

IEC	AAMI/AHA	Electrode placement
R (red)	RA (white)	Just below the right clavicle.
L (yellow)	LA (black)	Just below the left clavicle.

Respiration lead II electrode placement

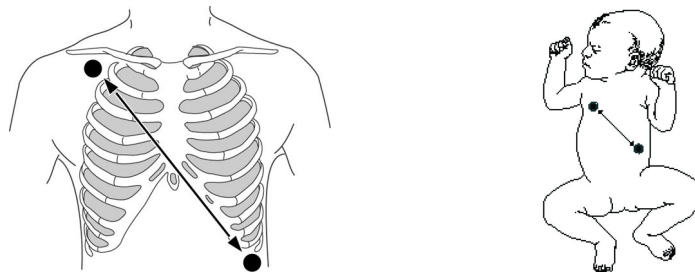

ECG lead II for chest or upper abdominal breather

IEC	AAMI/AHA	Electrode placement
R (red)	RA (white)	Just below the right clavicle.
F (green)	LL (red)	Lower left edge of the rib cage.

Respiration lead RL-LL electrode placement

NOTE The RL-LL respiration lead is available with PDM only.

When monitoring respiration through the RL-LL vector, use a standard 5- or 6-leadwire electrode placement, except place the RL electrode on the fifth intercostal space on the right side of the chest. Impedance respiration lead between V5R and LL provides maximum respiration signal strength, minimum noise/artifact content, and minimum cardiogenic artifact.

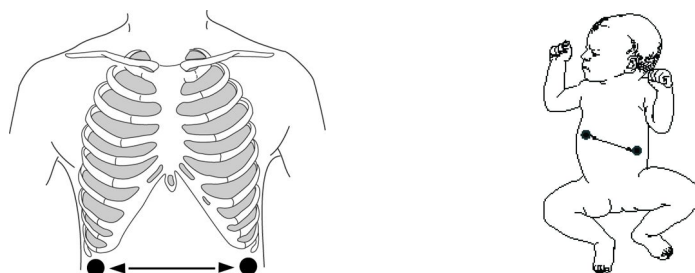

RL-LL vector for abdominal breather

IEC	AAMI/AHA	Electrode placement
N (black)	RL (green)	Fifth intercostal space on the right.
F (green)	LL (red)	Lower left edge of the rib cage.

Respiration measurement checks

1. Check that the waveform and parameter value are displayed when the cable is connected to the patient.

NOTE

There may also be a respiration rate value displayed in the CO₂ parameter window. Only the value in the respiration parameter window is measured from the impedance respiration source.

Respiration measurement on the monitor screen

- The spikes in the waveform indicate detected inspiration and expiration.
- PDM and TRAM: A text similar to **APN 15 s** indicates the value to which the apnea alarm delay is set. In this example, the value is set to 15 seconds. It means that the apnea alarm will activate after 15 seconds from the last detected breath.

Using the respiration measurement

Turning on the respiration measurement

The respiration measurement does not start automatically, so you must select it on.

1. Select the impedance respiration parameter window.
2. Select the **Setup** tab.
3. Select **Respiration Measurement > On**.

Selecting the respiration lead

NOTE

TRAM and PDM only. In addition, the **RL-LL** respiration lead is available with PDM only.

1. Select the impedance respiration parameter window.
2. Select the **Setup** tab.
3. Select lead **I**, **II**, or **RL-LL** from the selection list on the right. Lead selections are presented as graphical icons.

Selecting the respiration waveform size manually

1. Select the impedance respiration parameter window.
2. Select the **Setup** tab.
3. Select a value from the **Size** list.

The greater the value, the larger the waveform size.

Selecting the respiration waveform size automatically

NOTE

PDM and TRAM only.

You can automatically size the waveform to fit the available space.

1. Select the impedance respiration parameter window.

2. Select the **Setup** tab.
3. Select **Autosize Waveform**.

Selecting the waveform speed

1. Select the impedance respiration parameter window.
2. Select the **Setup** tab.
3. Select a value from the **Resp Sweep Speed** list.

The lower the value, the slower the sweep speed.

Selecting the waveform sensitivity

Breath detection accuracy may be enhanced by increasing or decreasing the waveform sensitivity.

1. Select the impedance respiration parameter window.
2. Select the **Setup** tab.
3. Select a value from the **Sensitivity** list.

The lower the value, the greater the sensitivity.

Relearning the respiration pattern

NOTE PDM and TRAM only.

If the patient's breathing pattern changes after the initial learning process has taken place, it may be necessary to relearn. There is no respiration rate displayed during the relearning process. When relearning is complete, the **Relearn Respiration** message will clear and the respiration rate will be displayed. The detection threshold and the waveform size update after the new respiration pattern is learned.

1. Select the impedance respiration parameter window.
2. Select the **Setup** tab.
3. Select **Relearn Respiration**.

The detection threshold (sensitivity) and the waveform size update after the new respiration pattern is learned.

Turning on or off the respiration rate alarm

1. Select the impedance respiration parameter window.
2. Select the **Alarms** tab.
3. Select **Alarm On** or **Alarm Off** for the **Resp Rate (Impedance)**.

If you select **Alarm Off**, you cannot adjust the alarm limits.

Setting the respiration alarm limits

1. Select the impedance respiration parameter window.
2. Select the **Alarms** tab.
3. Set the **Respiration Rate** limits with the arrow selectors.

Setting the apnea alarm delay

NOTE PDM and TRAM only. The delay for the PSM is always 20 seconds.

You can select the apnea alarm delay by defining seconds in the **Apnea Limit Seconds** setting (3 - 30 seconds). If anything else than the default (20 seconds) is selected, the selected seconds are displayed in the parameter window.

1. Select the impedance respiration parameter window.
2. Select the **Alarms** tab.
3. Set the **Apnea Limit Seconds** with the arrow selectors.

Apnea alarms' deactivation with the pause audio key

Apnea alarms can be deactivated with the pause audio key if the **Allow alarm deactivation with the Audio Pause key for:** setting **Apnea (CO2/Imped)** is enabled in the **Care Unit Settings**. This setting is password protected.

For more information, see the supplemental information manual.

Enabling the respiration cardiac artifact alarm

NOTE PDM and TRAM only.

The cardiac artifact alarm can be enabled to display the **Cardiac artifact** message when the respiration rate is within 5% of the ECG heart rate. It takes about 30 breaths before the module detects a cardiac artifact alarm condition.

1. Select the impedance respiration parameter window.
2. Select the **Alarms** tab.
3. Select **Cardiac Artifact > Alarm On**.

Respiration alarm priorities

You can select priorities for the **Apnea (Impedance)** and **RR (Impedance) high/low** alarms through **Alarm Setup > Alarm Priorities > Other Parameters**. The available choices depend on what has been allowed in the **Care Unit Settings** (password protected setting). If all priorities have been allowed, you can select one of the following:

- **Escalating**
- **High**
- **Medium**
- **Low**
- **Informational (Apnea (Impedance) only)**

Turning off the respiration measurement

1. Select the impedance respiration parameter window.
2. Select the **Setup** tab.
3. Select **Respiration Measurement > Off**.

Respiration measurement description

When starting respiration monitoring, the system “learns” the patient’s respiration pattern. The respiration rate is calculated from impedance changes and a respiration waveform is displayed.

Respiration measurement with PSM

With impedance respiration **Sensitivity** set to **AUTO**, two breaths are averaged and the average amplitude of the respiration waveform is found. Detection sensitivity is automatically set at one half of the average amplitude. Sensitivity dotted lines displayed on the waveform show the minimum detection range which is 25%. The percentage is the ratio to the reference bar on the left in the waveform display, which corresponds to 100%. The user can manually set the impedance respiration **Sensitivity** to **20%**, **40%**, **60%**, **80%**, or **100%** and the sensitivity dotted lines displayed on the waveform will show the selected detection range. The percentage is shown with a reference bar that corresponds to 100%, meaning that the **100%** selection uses the whole drawing area. The bar is on the left in the waveform display.

Respiration measurement with PDM and TRAM

Eight breaths are averaged and the average amplitude of the respiration waveform is found. Detection sensitivity is automatically set at 40% of the average amplitude. Sensitivity dotted lines displayed on the waveform show this 40% detection range. Once learning is complete, the user can adjust the detection sensitivity to 10, 20, 30, 40, 50, 60, 70, 80, or 90%.

How to interpret the respiration values



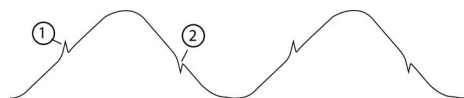

The following is an example of a regular and even respiratory waveform, with the inspiration and expiration markers identified (1 = inspiration marker, 2 = expiration marker).

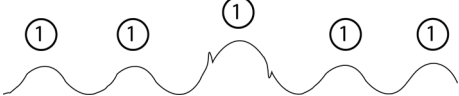

Respiration troubleshooting

Problem	Solution
What can I do if the respiration measurement fails?	<ul style="list-style-type: none"> • Check electrode quality and positioning. • Adjust the breath detection sensitivity. During ventilator-supported breathing, the respiration calculation may count only ventilator-produced inspirations and expirations.

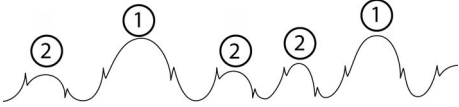
Impedance respiration

Problem	Solution
	<ul style="list-style-type: none"> Other electrical devices may interfere with the measurement.
<p>Why does the waveform have a combination of shallow and deep breaths, but the monitor is not detecting the shallow breaths?</p>	<p>If the detection sensitivity threshold is set too high, shallow breaths will not be detected, as shown in the following example of incorrect detection (1 = breath).</p>  <ul style="list-style-type: none"> Decrease the detection sensitivity percentage until the markers correctly identify each inspiration and expiration or set to AUTO (PSM). If the detection mode is AUTO, the grid lines represent the minimum limits. The limits in use may be a larger range. The following is an example of correct detection.  <p>Respiration detection is not dependent on the size of the waveform. Size is for visual purposes only.</p>
<p>Why is the monitor detecting cardiac artifact as breaths?</p>	<p>The breath detection threshold is too low (1 = breath, 2 = artifact). The following is an example of incorrect detection.</p>  <ul style="list-style-type: none"> Increase the detection sensitivity percentage until the markers correctly identify each inspiration and expiration. The following is an example of correct detection. 

10

Pulse oximetry

SpO₂ compatibility limitations

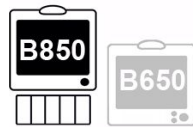

TRAM and Tram-Rac modules with the B850 only.

For detailed information regarding module, monitor, and accessory compatibility, see the supplemental information manual.

SpO₂ safety precautions

SpO₂ warnings

- WARNING** The operator is responsible for checking the compatibility of the pulse oximetry monitor, sensor, and patient cable prior to use. Incompatible components can result in degraded performance and/or device malfunction.
- WARNING** If the accuracy of any measurement does not seem reasonable, first check the patient's vital signs, then check for conditions that may cause inaccurate SpO₂ readings. If the problem is still not resolved, check the monitor and the SpO₂ module, cable, or sensor for proper functioning.
- WARNING** A pulse oximeter should not be used as an apnea monitor. A pulse oximeter should be considered an early warning device. As a trend toward patient deoxygenation is indicated, blood samples should be analyzed by a laboratory CO-oximeter to completely understand the patient's condition.
- WARNING** Check that the pulse oximetry waveform is physiological in shape to ensure waveform quality and minimize noise spikes caused by motion conditions. (Not applicable when monitoring SpO₂ with Masimo SET technology.)
- WARNING** To prevent erroneous readings, do not use physically damaged sensors, cables or modules. Discard a damaged sensor or cable immediately. Never repair a damaged sensor or cable; never use a sensor or cable repaired by others.

WARNING Pulse rate measurement is based on the optical detection of a peripheral flow pulse and therefore may not detect certain arrhythmias. The pulse oximeter should not be used as a replacement or substitute for ECG-based arrhythmia analysis.

WARNING Cable/sensor after care:

- Do not reuse sensors intended for single patient use.
- Do not sterilize sensors or patient cables by irradiation, steam, or ethylene oxide.
- Clean the surface of the probe before and after each patient use.
- Allow sensor and cable to dry completely after cleaning. Moisture and dirt on the connector can affect the measurement accuracy.
- If a probe is damaged in any way, discontinue use immediately.
- Inaccurate SpO₂ data can result if a sensor is past its useful life. Therefore, re-evaluate the measurement periodically by performing additional assessment of the patient and equipment, including consideration of use of alternate monitoring methods such as direct measurement of arterial oxyhemoglobin saturation (SaO₂).
- A damaged sensor may cause burns during electrosurgery.

WARNING Oximetry performance may be impaired when patient perfusion is low or signal attenuation is high.

WARNING — B850 only: CABLE COMPATIBILITY — Tram 451N and Tram 851N modules require Nellcor Oxismart XL cables and sensors. Older (non-Oxismart XL) cables must not be plugged in to the SpO₂ connector on these modules. Use of non-Oxismart XL cables may result in erroneous readings.

WARNING — NEONATAL — The display of inaccurate pulse oximetry (SpO₂) values has been linked to the presence of poor signal strength or artifact due to patient motion during signal analysis. This condition is most likely to be encountered when the monitor is used on neonates or infants. These same conditions in adults do not impact the SpO₂ values to the same extent.

We recommend the application of the following criteria when using the pulse oximetry function on neonates and infants:

- The peripheral pulse rate (PPR) as determined by the SpO₂ function must be within 10% of the heart rate, and
- The SpO₂ signal strength should be adequate. This is indicated by the display of two or three asterisks or the absence of the **Low signal quality** message.

Procedures or devices previously applied in your facility for SpO₂ monitoring should be used in the event the SpO₂ value from the monitor cannot be validated by the above criteria.

WARNING

Many factors may cause inaccurate readings and alarms, decreased perfusion, and or low signal strength:

- Interfering substances:
 - Carboxyhemoglobin may erroneously increase SpO₂ reading.
 - Methemoglobin (MetHb) usually represents less than 1% of the total Hb, but in the case of methemoglobinemia that can be congenital or induced by some IV dyes, antibiotics (such as sulphas,) inhaled gases etc. this level increases sharply and thus can cause inaccuracies in the SpO₂ reading.
 - Intravascular dyes (such as indocyanine green, methylene blue, etc.)
- Physiological characteristics:
 - Cardiac arrest
 - Hypotension
 - Shock
 - Severe vasoconstriction
 - Severe anemia
 - Hypothermia
 - Venous pulsations
 - Darkly pigmented skin
 - Ventricular septal defects (VSDs)
- Environmental conditions:
 - Excessive ambient light
 - Electrical interference
 - Electrosurgery
 - Defibrillation - May cause inaccurate reading for a short amount of time.
 - Excessive patient/sensor motion. Artifact can simulate an SpO₂ reading, so that the monitor fails to sound an alarm. In order to ensure reliable patient monitoring, the proper application of the probe and the signal quality must be checked at regular intervals.
- Sensor placement:
 - Incorrect sensor placement - prolonged monitoring or incorrect sensor application can cause skin irritation or impaired circulation. It is recommended that you check the probe site every four hours (more frequently for poor perfusion or for neonates). Refer to the instructions supplied with the sensor.
 - Sensor placement on the same extremity as a blood pressure cuff, arterial catheter or intravascular line; or arterial occlusion proximal to the sensor.
 - Poor sensor fit.
 - Do not allow tape to block the sensor light emitter and detector.

- WARNING** — FAILURE TO DETECT LETHAL ARRHYTHMIA — Always monitor ECG for arrhythmia detection purposes. HR calculated from pulsatile SpO₂ waveform may differ significantly from ECG HR measured values. Users should be aware that the **SpO₂ probe off** and **No SpO₂ pulse** technical alarms escalate no higher than a **Medium** priority.
- WARNING** — FAILURE TO DETECT LETHAL ARRHYTHMIA — The SpO₂ parameter pulsatile heart rate measurement is based on the optical detection of a peripheral flow pulse and therefore may not detect certain arrhythmias. The pulse oximetry parameter should not be used as a replacement or substitute for ECG based arrhythmia analysis.
- WARNING** Using the **Maximum** sensitivity setting delays the **SpO₂ probe off** detection alarm.
- WARNING** With deactivated **SpO₂ probe off** alarm, keep the patient under close surveillance.
- WARNING** — MISSED ALARM — Check the SpO₂ measurement when switching the SpO₂ measurement sources to avoid missed SpO₂ alarms.

SpO₂ cautions

- CAUTION** A damaged sensor or a sensor soaked in liquid may cause burns during electrosurgery.
- CAUTION** Prolonged monitoring or incorrect sensor application can cause skin irritation or impaired circulation. It is recommended that you check the probe site every four hours (more frequently in case of poor perfusion or neonatal patients). Refer to the instructions supplied with the sensor.

SpO₂ measurement limitations

- Other E-modules than E-MASIMO and E-NSATX used for this measurement are not suitable for use with neonatal patients.
- The pulse oximeter cannot distinguish between oxyhemoglobin and dyshemoglobins.
- Poor perfusion may affect the accuracy of measurement, especially when using an ear sensor.
- To avoid erroneous measurements, do not use a blood pressure cuff on the same limb as the SpO₂ sensor.

SpO₂ points to note

- GE sensors are not made with natural rubber latex.
- Use dry and clean sensors only.
- Do not use damaged sensors.
- Check that you are not re-using a disposable sensor or other disposable accessories.

- Primary and secondary SpO₂ sites may be measured.
- Always check the patient and the sensor site if the accuracy of the SpO₂ values is questionable.
- Depending on the SpO₂ module used, not all SpO₂ measurements and settings are available to view or change.
- SpO₂ signal strength indicators are displayed for all modules except Unity Network Interface Device (ID).
- There are four supported pulse oximetry technologies:
 - Masimo SET: PDM, TRAM, Tram-Rac and E-MASIMO modules.
 - Nellcor OxiMax: TRAM, PDM, and E-NSATX modules.
 - GE Ohmeda: PSM.
 - GE Marquette: TRAM and Tram-Rac modules.

SpO₂ measurement guidelines

GE Ohmeda technology and sensor measurement guidelines

The following measurement guidelines apply to GE Ohmeda technology:

- The time period for acquiring a measurement average is adjustable.
- The SpO₂ waveform corresponds to (but is not proportional to) the arterial pressure waveform.
- Only TruSignal sensors are supported.
- Use the following guidelines when using TruSignal sensors and cables:
 - Read the sensor instructions for use of the SpO₂ sensor before using it.
 - Periodically inspect extension cables and sensors for damage.
 - Do not use damaged sensors.
 - Refer to the cleaning instructions in the instructions for use of reusable TruSignal sensors.
 - Do not use NIBP or constricting instruments on the same appendage as the SpO₂ sensor.

Masimo SET technology and sensor measurement guidelines

With motion, the plethysmographic waveform (or SpO₂ waveform) is often distorted and may be obscured by the artifact. With Masimo SET technology, the plethysmographic waveform is not an indication of signal quality or validity. Even with a waveform obscured by artifact, Masimo SET technology is able to read through the noise and locate the arterial pulsation.

Although Masimo SET technology processes SpO₂ measurements differently than other SpO₂ technologies, the function and appearance is essentially the same as other technologies. The following measurement guidelines apply to Masimo SET:

- The time period for acquiring a measurement average is adjustable.

- Only Masimo LNOP or LNCS sensors are supported. Masimo LNOP or LNCS sensors non-invasively measure pulse rate and the amount of oxygenated hemoglobin. Use the following guidelines when using Masimo LNOP or LNCS sensors:
 - Read the sensor directions before use.
 - Only use sensors with Masimo SET technology.
 - Do not use damaged LNOP or LNCS sensors.
 - Do not use an LNOP or LNCS sensor with exposed optical components.
 - Refer to the cleaning instructions in the directions for use for reusable Masimo LNOP or LNCS sensors.

Additional information for MASIMO technology

NO IMPLIED LICENSE: Possession or purchase of this device does not convey any express or implied license to use the device with unauthorized replacement parts which would, alone, or in combination with this device, fall within the scope of one or more of the patents relating to this device. Sensors that are designated for single use are licensed for use on a single patient only, and are not sold. There is no license, implied or otherwise, that would allow use of single use Masimo Sensors beyond their intended single use. After use of single use Masimo Sensors, the license is exhausted, there is no further license granted by MASIMO, and they must be discarded.

This device is covered under one or more patents as set forth at <http://www.masimo.com/patents.htm>.

We recommend the use of Masimo SET sensors for use with Masimo technology.

Nellcor OxiMax technology and sensor measurement guidelines

The following measurement guidelines apply to Nellcor OxiMax:

- The SpO₂ waveform corresponds to (but is not proportional to) the arterial pressure waveform.
- Only Nellcor OxiMax sensors are supported. Use the following guidelines when using OxiMax SpO₂ accessories and sensors:
 - Periodically inspect extension cables and sensors for damage and discontinue use if damage is found.
 - Do not immerse sensors.
 - Do not use NIBP or constricting instruments on the same appendage as the SpO₂ sensor.

Additional information for Covidien technology

NOTICE: Purchase of this instrument confers no express or implied license under any Covidien patent to use this instrument with any oximetry, level of consciousness, regional oxygen saturation and respiration rate, as applicable Sensor that is not manufactured or licensed by Covidien.

For patients with SpO₂ levels in the 60% to 80% range, the LoSat accuracy feature is available. For more information, see the supplemental information manual.

SpO₂ measurement setup

SpO₂ equipment to patient connection

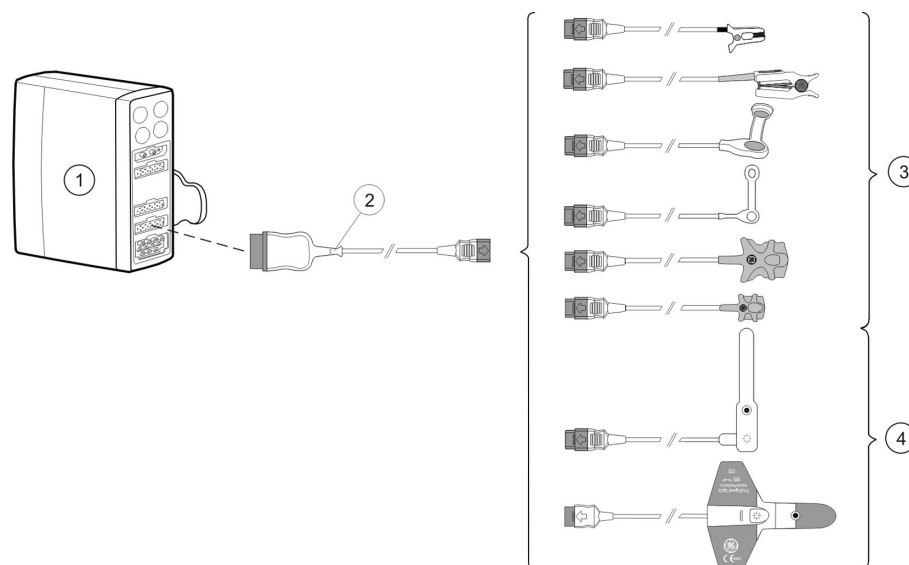

1. Acquisition module with SpO₂ measurement capability
2. Interconnect cable
3. Reusable sensors
4. Disposable sensors

Preparing the SpO₂ connection

1. Connect the SpO₂ module(s) to the monitor.
2. Connect the adapter cable(s) to the SpO₂ module connector(s).
3. Clean the surface of reusable sensors.
4. Prepare the application site(s).
5. Remove nail polish and earrings.
6. Follow the sensor manufacturer's instructions to position the sensor(s).
7. Attach the sensor(s) to the patient.
8. Stabilize the sensor cable(s) to minimize sensor movement.

Checking the SpO₂ measurement

1. Check that the red light is lit in the sensor.
2. Check that the waveforms and parameter values are displayed when the sensor is connected to the patient.

SpO₂ functional testers

Some models of commercially available bench-top functional testers and patient simulators can be used to verify proper functionality of pulse oximeter sensors, cables and monitors. While such devices may be useful for verifying that the pulse oximetry

system is functional, they are incapable of providing the data required to properly evaluate the accuracy of the system's SpO₂ measurements.

Many functional testers and patient simulators have been designed to interface with the pulse oximeter's expected calibration curves, and may be suitable for use with the pulse oximeter monitor and sensors. Not all devices, however, are adapted for use with all digital calibration systems. While this will not affect use of the simulator for verifying system functionality, displayed SpO₂ measurement values may differ from the setting of the device. For a properly functioning monitor, this difference will be reproducible over time and from monitor to monitor within the performance specifications of the test device.

If a particular calibration curve is accurate for the combination of a pulse oximeter monitor and sensor, a functional test device can measure the contribution of a monitor to the total error of a monitor/sensor system. The functional test device can then measure how accurately a particular pulse oximeter monitor is reproducing that calibration curve.

Using the SpO₂ measurement

Primary and secondary SpO₂ measurement sources

It is possible to measure SpO₂ from two different measurement sources simultaneously. The primary SpO₂ source is labeled **SpO2** and the secondary SpO₂ source is labeled **SpO2(2)**.

The following table shows the acquisition modules that may be used as primary and secondary SpO₂ measurement sources.

Primary SpO ₂ source	Compatible secondary SpO ₂ source(s)
PDM, TRAM, PSM	<ul style="list-style-type: none"> • Tram-Rac SpO₂ module • E-NSATX • E-MASIMO • Unity Network ID connectivity device
E-NSATX, E-MASIMO	<ul style="list-style-type: none"> • Unity Network ID connectivity device
Unity Network ID connectivity device	<ul style="list-style-type: none"> • Tram-Rac SpO₂ module • E-NSATX • E-MASIMO <p>E-NSATX and E-MASIMO modules require a PDM with no SpO₂ sensor connected in order to work as a secondary SpO₂ source when the Unity Network ID connectivity device is the primary SpO₂ source.</p>

Changing the SpO₂ waveform size

NOTE All other modules except PSM.

1. Select the SpO₂ parameter window.
2. Select the **SpO2** or **SpO2(2)** tab.
3. Choose the size from the **Size** list: **1x**, **2x**, **4x**, or **8x**.

Changing the SpO₂ waveform scale

NOTE PSM only.

1. Select the SpO₂ parameter window.
2. Select the **SpO2** or **SpO2(2)** tab.
3. Select the scale from the **Scale** list:
 - **AUTO**: The scale is automatically selected according to the IrMod % (infrared modulation percentage) received from the measurement source.
 - Other scale options are **2, 5, 10, 20**, or **50**.

Selecting the SpO₂ hemodynamic sweep speed

NOTE This setting adjusts the waveform speed for all of the hemodynamic parameters.

1. Select the SpO₂ parameter window.
2. Select the **SpO2** or **SpO2(2)** tab.
3. Select a numeric value from the **Hemodynamic Sweep Speed** list.
The smaller the value, the slower the sweep speed.

Selecting the SpO₂ as the primary heart rate source

The primary heart rate can be calculated from the ECG leads, SpO₂ measurement, or invasive pressure waveform.

NOTE This setting adjusts the primary heart rate source for all of the hemodynamic parameters.

NOTE **HR Alarms** must be configured as **Single** to enable the SpO₂ as the primary heart rate source.

NOTE Primary SpO₂ measurement only.

SpO₂ can be the **Primary HR Source** for all modules except the Tram-Rac single parameter modules.

1. Select the SpO₂ parameter window.
2. Select the **SpO2** tab.
3. Select the heart rate source from the **Primary HR Source** list.

Showing the SpO₂ pulse rate

1. Select the SpO₂ parameter window.
2. Select the **SpO2** or **SpO2(2)** tab.
3. Select **Show Pulse Rate**.

Adjusting the SpO₂ pulse beep tone volume

A variable pitch beep tone rises in pitch with increasing oxygen saturation or falls in pitch with decreasing oxygen saturation.

1. Select the SpO₂ parameter window.
2. Select the **SpO2** tab.
3. Adjust the volume with the **Beat Volume** arrows.

Variable beat tone

You can configure a variable beat tone through **Monitor Setup > Default Setup > Care Unit Settings > Parameters > Variable Beat Tone**. This setting is password protected.

If it set to **All beat sources**, the SpO₂ saturation affects all beep sounds including ECG and IP when the SpO₂ measurement is available: beep frequency changes according to increasing and decreasing SpO₂ values. If the setting is set to **Only SpO2**, other beep sounds are not affected by the changing SpO₂ values.

For more information, see the supplemental information manual.

Masimo SET data averaging and updating

For Masimo SET technology, when using the default averaging time of 8 seconds, there is a maximum data-averaging signal processing time of 10 seconds from real time plus an additional delay of 2 seconds to update the displayed waveform. Audible alarms are delayed until an alarm limit violation occurs for at least 5 seconds.

Selecting the SpO₂ averaging time

NOTE PSM, E-MASIMO, and PDM and TRAM with Masimo technology and Masimo sensors only. The primary SpO₂ measurement only.

You can have an average of the SpO₂ measurement on screen instead of the beat to beat values, and you can select how many seconds are used for this averaging: **2 s, 4 s, 8 s, 10 s, 12 s, 14 s, or 16 s**.

1. Select the SpO₂ parameter window.
2. Select the **SpO2** tab.
3. Select the number of seconds from the **Averaging** list.

Selecting the Masimo SpO₂ sensor sensitivity level

NOTE SpO₂ modules with Masimo technology and Masimo sensors only.

1. Select the SpO₂ parameter window.
2. Select the **SpO2** tab.
3. Select the appropriate **Sensitivity** radio button:
 - Use the **Normal** sensitivity setting for normal patient monitoring purposes.
 - Use the **Maximum** sensitivity setting for improved poor perfusion performance and for faster tracking of rapid SpO₂ saturation changes.

Using the **Maximum** sensitivity setting delays the **SpO2 probe off** detection alarm.

Nellcor OxiMax data averaging and updating

The Nellcor OxiMax algorithm automatically extends the amount of data required for measuring SpO₂ and pulse rate depending on the measurement conditions. During normal measurement conditions in the normal response mode, the averaging time is 6 to 7 seconds.

During difficult measurement conditions, which can be caused by low perfusion, motion, ambient light, electrocautery, other interference, or a combination of these factors, the OxiMax algorithm automatically extends the dynamic averaging time required beyond 7 seconds.

If the resulting dynamic averaging time exceeds 20 seconds, the pulse search condition will be set, while SpO₂ and pulse rate values continue to be updated every second.

As the measurement conditions become even more difficult, the amount of data required continues to expand. If dynamic averaging time reaches 40 seconds, the pulse timeout condition will be set and the module will report a zero saturation indicating a loss-of-pulse condition.

Selecting the SpO₂ response time

NOTE PDM Nellcor only.

You can select the response (averaging) time. **Fast** (default) is the recommended setting.

1. Select the SpO₂ parameter window.
2. Select the **SpO2(2)** or **SpO2(2)** tab.
3. Select the radio button for the response time: **Normal** or **Fast**.

Nellcor OxiMax Saturation Seconds alarm management

NOTE PDM and TRAM with primary SpO₂ measurement and the Nellcor option only.

The Saturation Seconds feature has a “safety net” designed for patients whose saturation is frequently outside the limits but does not remain outside the limits long enough for the Saturation Seconds limit to be reached. When three or more limit violations occur within 60 seconds, an alarm sounds even if the Saturation Seconds limit has not been reached.

Nellcor OxiMax technology uses the Saturation Seconds to decrease the likelihood of false SpO₂ saturation alarms caused by motion artifact. It does not apply to pulse rate.

With traditional pulse oximetry alarm management, upper and lower alarm limits are set. During monitoring, as soon as a limit is violated, an alarm is generated. With Saturation Seconds alarm management, upper and lower alarm limits are set in the same way as traditional alarm management. If the alarm priority is **Escalating**, the alarm priority limit automatically changes to **Medium**.

A Saturation Seconds limit is also set. This allows monitoring of SpO₂ saturation outside the set limits for a period of time (count value) before an alarm sounds. The method of calculation is as follows: The number of percentage points that the SpO₂ saturation falls outside the alarm limit is multiplied by the number of seconds that it remains outside the limit. This can be stated as the equation “points x seconds =

Saturation Seconds,” where points equals SpO₂ percentage points at or outside the limit, and seconds equals the number of seconds SpO₂ remains at that point outside the limit.

The following table demonstrates the alarm response time with a Saturation Seconds limit set at 30 and a low limit of 80%. The SpO₂ level drops to 79% (2 points) and remains there for two seconds. Then it drops to 76% (5 points) for three seconds, and then to 75% (6 points) for two seconds. The resulting Saturation Seconds are:

SpO ₂ saturation change	Clock seconds	Saturation Seconds
2x	2 =	4
5x	3 =	15
6x	2 =	12
Total Saturation Seconds		31

After approximately seven seconds, the alarm would sound because 30 Saturation Seconds would have been exceeded (arrow in the following figure).

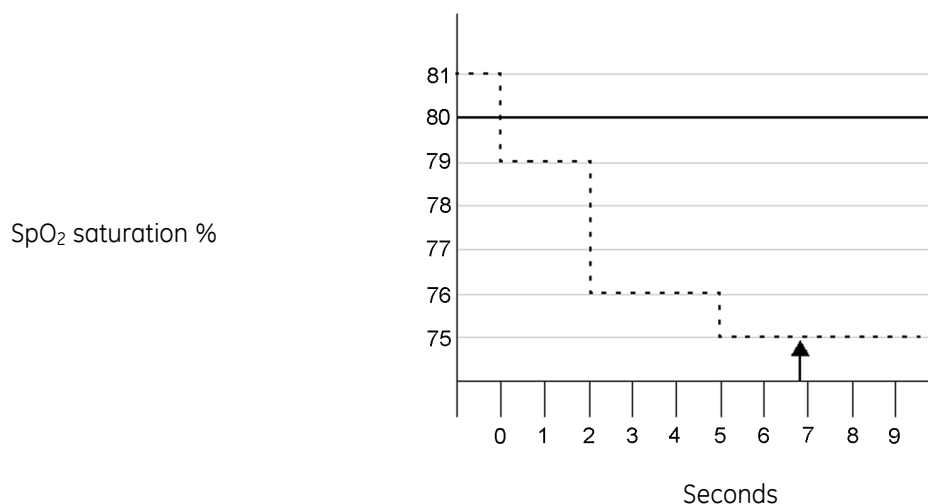

Saturation Seconds alarm response example

Saturation levels may fluctuate above and below an alarm limit, re-entering the acceptable range (non-alarm range) several times. During such fluctuation, the monitor integrates the number of SpO₂ saturation points, both positive and negative, until either the Saturation Seconds limit is reached or the saturation level returns to within the normal range and remains there.

When an SpO₂ saturation value exceeds an alarm limit, a pie chart (circular graph) in the SpO₂ parameter menu begins to fill in a clockwise direction. As seconds pass and the value is compared against the alarm limits and the Saturation Seconds setting, the chart fills proportionately. When the pie chart is completely filled, indicating that the Saturation Seconds limit has been reached, an alarm sounds. When the SpO₂ value is within the set limits, the Saturation Seconds pie chart empties in a counterclockwise direction.

Showing the Saturation Seconds in the SpO₂ parameter window

NOTE PDM and TRAM with primary SpO₂ measurement and the Nellcor option only.

1. Select the SpO₂ parameter window.
2. Select the **SpO2** tab.
3. Select **Show Sat. Seconds**.

Setting the Saturation Seconds threshold

1. Select the SpO₂ parameter window.
2. Select the **SpO2** tab.
3. Set the threshold with the **Saturation Seconds** arrows.

Setting the SpO₂ alarms and alarm limits

You can set the alarms and alarm limits for primary and secondary SpO₂ measurements separately.

1. Select the SpO₂ parameter window.
2. Select the **SpO2** or **SpO2(2)** tab.
3. Select the **Alarms** tab.
4. Set the alarm limits for the **SpO2**, **HR**, or **PR(SpO2)**.

If a feature is not active, alarm limits are greyed out. Select **Alarm On** to set the alarm limits. **HR** appears when the **HR Alarms** is set to **Single**. **PR(SpO2)** appears when the **HR Alarms** is set to **Multiple**. The **HR** and **PR(SpO2)** settings are not available for the secondary SpO₂ measurement.

5. Set the alarm limits.

Deactivating the SpO₂ probe off alarm

This feature is meant to be used when ending SpO₂ monitoring. It should not be used during active SpO₂ monitoring. This setting can be enabled during configuration. If it has been enabled, there will be a button on the **SpO2** and **SpO2(2)** tabs that allows you to deactivate the alarm:

1. Select the SpO₂ parameter window.
2. Select the **SpO2** or **SpO2(2)** tab.
3. Select **Deactivate SpO2 Probe Off**.

When the alarm is deactivated, there will be no audible or visual **SpO2 probe off** alarm indications. The alarm is automatically reactivated if SpO₂ vital signs are detected and alarm condition is met again.

WARNING

With deactivated **SpO2 probe off** alarm, keep the patient under close surveillance.

SpO₂ alarm priorities

You can select priorities for the **SpO2 high**, **SpO2 low**, and **SpO2 probe off** alarms through **Alarm Setup > Alarm Priorities > Other Parameters**. The choices are **Low**, **Medium**, **High**, and **Escalating**.

Stopping the SpO₂ measurement

1. Remove the SpO₂ sensor from the patient.

2. Disconnect the sensor from the sensor cable.
3. Disconnect the sensor cable from the module.
4. Select  to acknowledge the **SpO2 probe off** alarm.
5. Discard single-use sensors.
 - Always disconnect the LNOP or LNCS sensor from the cable before repositioning the sensor. Reconnect the cable to the LNOP or LNCS sensor after the sensor has been repositioned.
 - Use only sensors and cables listed in the supplemental information manual.

How to interpret the SpO₂ values

SpO₂ signal strength

Signal strength is indicated with asterisks in the parameter window.

For PSM with GE Ohmeda technology, the signal strength indicator is also displayed as the infrared modulation percentage in the waveform.

Unity Network Interface Device (ID) does not display signal strength indicators. Signal strength may be determined by the amplitude of the SpO₂ waveform.

SpO₂ waveform quality

NOTE Not for Masimo SET technology.

Under normal conditions, the SpO₂ waveform corresponds to (but is not proportional to) the arterial pressure waveform. The typical SpO₂ waveform can help the user find a sensor location with the fewest noise spikes.



Normal waveform

If noise (artifact) is seen on the waveform because of poor sensor placement, the photodetector may not be flush with the tissue. Check that the sensor is secured and the tissue sample is not too thick. Pulse rate is determined from the SpO₂ waveform, which can be disrupted by hemodynamic pressure disturbances. Motion at the sensor site is indicated by noise spikes in the normal waveform.



Abnormal waveform

SpO₂ waveform stability

The stability of the displayed SpO₂ values can also be used as an indication of signal validity. To aid you in successful SpO₂ monitoring, messages are provided in the SpO₂ parameter window.

SpO₂ wavelengths and optical output power

GE Ohmeda, Masimo SET and Nellcor OxiMax pulse oximetry are calibrated to display functional saturation.

This information may be useful to clinicians such as those performing photodynamic therapy:

- Nellcor OxiMax pulse oximetry sensors contain LEDs that emit red light at a wavelength of approximately 660 nm and infrared light at a wavelength of approximately 900 nm. The total optical output power of the sensor LEDs is less than 15 mW.
- Masimo SET pulse oximetry sensors contain LEDs that emit red light at a wavelength of approximately 660 nm and infrared light at a wavelength of approximately 905 nm for LNOP and LNCS, and approximately 663 nm and 880 nm for LNOP and LNCS tip clips. The total optical output power of the LEDs is less than or equal to 15 mW.
- GE Ohmeda SpO₂ for use with TruSignal sensors only: GE pulse oximetry sensors contain LEDs that emit red light at a wavelength of approximately 663 nm and infrared light at a wavelength of approximately 890 or 940 nm. The maximum optical output power for each LED is less than 15mW.

SpO₂ measurement and interference

These types of interference can influence the function of SpO₂:

- Incorrect sensor application, e.g., sensor placement on an extremity with a blood pressure cuff, arterial catheter, or intravascular line, sensor applied too tightly.
- Intravascular dyes, such as indocyanine or methylene blue.
- Externally applied coloring agents with opaque materials in high ambient light conditions, e.g., conditions created from one or more of the following sources:
 - Surgical lights, especially xenon light sources
 - Bilirubin lamps
 - Fluorescent lights
 - Infrared heating lamps
 - Direct sunlight
- Excessive patient activity
- Venous pulsation
- Dysfunctional hemoglobin
- Poor (low) peripheral perfusion
- Arterial occlusion proximal to the sensor
- Loss of pulse (cardiac arrest)
- Electromagnetic interference (EMI)
- Ventilator-induced pressure change

SpO₂ troubleshooting

Problem	Solution
SpO ₂ signal is poor	<ul style="list-style-type: none"> • Check the sensor and sensor position. • Make sure the patient is not shivering, moving, or does not have tremors. • The patient's pulse may be too low to measure.
Unable to adjust alarm limits	The alarm limits are not adjustable when the measurement source is from an external device connected to the Unity Network ID connectivity device.
Deactivated SpO ₂ probe off alarm keeps alarming when the sensor is disconnected from the patient.	<ul style="list-style-type: none"> • Ensure that the sensor is protected from ambient light.
Why does the pulse oximeter sometimes read differently than a blood gas analyzer?	Blood gas analyzers calculate the O ₂ saturation based on normal values for pH, PaCO ₂ , Hb, temperature, etc. (i.e., a normal oxyhemoglobin dissociation curve). Depending on the patient's physiologic and metabolic status, this curve and all values may be shifted away from normal. Thus the oximeter, which measures O ₂ saturation, may not agree with the blood gas.
What effect can ambient light have on pulse oximetry monitoring?	Light sources such as surgical lamps, bilirubin lamps, fluorescent lights, infrared heating lamps, and sunlight can cause poor waveform quality and inaccurate readings. Error messages are possible. Shielding the sensor with opaque tape, the posey wrap, or other dark or opaque material can increase oximetry accuracy, verified by good waveform and signal strength.
What does electro-surgical interference look like and how can it be minimized?	<p>Electrosurgical interference is most obvious on the displayed waveform. It is a very spiky, erratic looking waveform caused by the electrosurgical unit's overwhelming interference. It can result in grossly inaccurate pulse oximeter results.</p> <p>Electrosurgical interference can be minimized by:</p> <ul style="list-style-type: none"> • Making sure the pulse oximeter sensor is as far away from the return pad and operating site as possible. • Making sure the sensor is not between the return pad and operating site. • Keeping the power cord and sensor cable away from the power cord of the electrosurgical unit. • Plugging the electrosurgery unit into a separate set of outlets from the monitor.
What does motion artifact look like, what problems can it cause, and how can it be corrected?	<p>For modules using Nellcor OxiMax and GE Marquette technologies, the main problem motion artifact can cause is erroneous SpO₂ readings.</p> <p>Motion artifact occurs with excessive motion of the sensor, the cable leading to the sensor, or the cable/sensor junction. In other words, anything that causes any of these things to move, like the patient moving his hands, or the cable lying across the ventilator tubing and being moved with every cycle, can cause motion artifact. A non-arterial, often erratic looking waveform and a pulse rate that does not coincide with the heart rate on the ECG will result.</p> <p>Motion artifact can be reduced, if not eliminated, by selecting a "quieter" site on the patient. An ear sensor if the hands do not remain still, an adhesive sensor on the toe, or an adhesive sensor on the little finger for an adult or on the sole of the foot in a newborn can help greatly.</p> <p>Cable movement can be reduced by applying the sensor with the cable leading toward the patient, then taping the cable to the side of the hand or foot. The cable and sensor can also be stabilized with a stress loop near the sensor. Tape</p>

Problem	Solution
	<p>the stress loop to the patient (excluding children). In the case of the butterfly sensor, the tape was designed to secure the cable to the finger.</p> <p>It has been noted that letting the patient view the SpO₂ waveform enables the patient to assist in reducing motion artifact.</p>
<p>Why is the parameter window not displayed on the monitor after connecting the SpO₂ interface cable and sensor?</p>	<p>No SpO₂ data is displayed due to two secondary SpO₂ modules in place at the same time, hardware failure or an unrecognized or defective sensor.</p> <ul style="list-style-type: none"> • Make sure the accessories are compatible with the module. • Make sure the sensor is attached to the interface cable and the cable is connected to the module. • Make sure there is only one secondary SpO₂ module connected to the monitor. • Change the sensor. • Change the cable. <p>If the problem persists, contact authorized service personnel.</p>

Non-invasive blood pressure

NIBP compatibility limitations

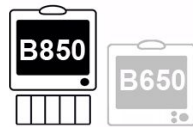

TRAM and Tram-Rac modules with the B850 only.

For detailed information regarding module, monitor, and accessory compatibility, see the supplemental information manual.

NIBP safety precautions

NIBP warnings

- WARNING** — PSM — Non-invasive blood pressure measurement is intended for patients weighing over 5 kg.
- WARNING** The NIBP parameter will not measure blood pressure effectively on patients who are experiencing seizures or tremors.
- WARNING** Arrhythmias will increase the time required by the NIBP parameter to determine a blood pressure and may extend the time beyond the capabilities of the parameter.
- WARNING** Do not apply external pressure against the cuff while monitoring. Doing so may cause inaccurate blood pressure values. Use care when placing the cuff on an extremity used to monitor other patient parameters.
- WARNING** NIBP cuff inflation/deflation may lead to inaccurate values from other monitored patient parameters that are measured distally from the NIBP measurement site at the same extremity.
- WARNING** Continuous cuff pressure caused by the kinking of the connection tubing can interfere with the blood flow and cause injury to the patient.
- WARNING** Do not place the cuff over a wound as this may cause further injury.

- WARNING** — NIBP AUTO DISCONTINUED — The NIBP Auto setting reverts to OFF when the Patient Data Module (PDM) is removed from one monitor and is connected to another monitor if the PDM battery is not installed. If the Patient Data Module (PDM) is used for bedside and transport monitoring, its battery should be installed when in use. In the event that the PDM battery is not installed, the settings for NIBP Auto can be reset after connecting the Patient Data Module to the monitor.
- WARNING** GE monitors are designed for use with dual-hose cuffs and tubing. The use of single-hose cuffs with dual hose tubing can result in unreliable and inaccurate NIBP data.
- WARNING** Do not place the cuff on a limb being used for A-V fistulas, intravenous infusion or on any area where circulation is compromised or has the potential to be compromised.
- WARNING** — PDM For SuperSTAT NIBP (Adult/Child) only — It takes one to three minutes for the NIBP parameter to identify an irregular rhythm after ECG is connected. For patients with irregular rhythms, simultaneous monitoring of ECG will enhance NIBP performance. Wait three minutes after ECG has been connected and ECG heart rate is present on the monitor screen before performing an NIBP determination.
- WARNING** Accuracy of NIBP measurement depends on using a cuff of the proper size. It is essential to measure the circumference of the limb and choose the proper size cuff.
- WARNING** — NIBP READINGS MAY TIME OUT WHEN USING IABP — An IABP balloon pump creates non-physiological arterial waveforms. These waveforms create an oscillometric signal that may not be interpreted by the NIBP algorithm, causing NIBP to time out. The patient blood pressure can be monitored from the balloon pump device.
- WARNING** The NIBP cuff size for PDM and TRAM or the inflation limits for PSM (with undetected cuff hoses) must be correctly selected in the NIBP **Setup** window to obtain reliable NIBP data and to prevent excessive cuff pressure during infant (neonate) or child (pediatric) use.
- WARNING** If a patient's beat-to-beat pulse amplitude varies significantly (e.g., because of pulsus alternans, atrial fibrillation, or the use of a rapid-cycling artificial ventilator), blood pressure and pulse rate readings can be erratic, and an alternate measuring method should be used for confirmation.

NIBP cautions

- CAUTION** The acquisition module sets the inflation pressure automatically according to the previous measurement. Reset the case or discharge the patient to reset the inflation limits before measuring NIBP on a new patient.

CAUTION

Devices that exert pressure on tissue have been associated with purpura, skin avulsion, compartmental syndrome, ischemia, and/or neuropathy. To minimize these potential problems, especially when monitoring at frequent intervals or over extended periods of time, make sure the cuff is applied appropriately and examine the cuff site and the limb distal to the cuff regularly for signs of impeded blood flow. Periodically check patient limb circulation distal to the cuff. Check frequently when using auto NIBP in 1 and 2 minute intervals. The 1 and 2 minute intervals are not recommended for extended periods of time.

NIBP measurement limitations

- A patient's vital signs may vary dramatically during the use of cardiovascular agents such as those that raise or lower blood pressure or those that increase or decrease heart rate.
- Although automated NIBP is generally safe and accurate, it has some limitations. It may be difficult to obtain reliable readings under the following circumstances:
 - Shock accompanied by low blood pressure and pulse.
 - Variations in blood pressure and pulse rate.
 - In patients with anatomic abnormalities, such as calcified (hardened) arteries or subclavian compression.
 - Compression of the cuff caused by shivering, seizures, arm movement, or bumping against the cuff.
- Proper sizing and position of the cuff are essential to obtaining reliable readings:
 - Too large a cuff is better than too small a cuff, which may yield falsely high readings.
 - The cuff should also fit properly over the brachial artery (or whatever artery is being used) so that the cuff is sufficiently sensitive to vibrations in the artery.

NIBP points to note

- This equipment is suitable for use in the presence of electrosurgery.
- Use the appropriate size NIBP cuff for the patient (adult, child, or infant).
- NIBP can be measured by multiple acquisition modules. Connect one NIBP cable only.
- Depending on the NIBP module used, not all NIBP measurements and settings are available to view or change.
- The measurement site, patient's position (standing, sitting, lying down), exercise, or physiologic condition can affect the NIBP readings.
- With mobile patients and when taking routine resting blood pressure, ensure that:
 - The patient is comfortably seated, with their legs uncrossed and feet flat on the floor.
 - The patient's arms and back are supported.
 - The middle of the cuff is at the level of the right atrium of the patient's heart.
- Also consider the following recommendations:
 - Allow 5 minutes to pass before taking the first measurement.

- Ensure that the patient is relaxed and does not talk during the measurement.

NIBP measurement setup

NIBP equipment to patient connection

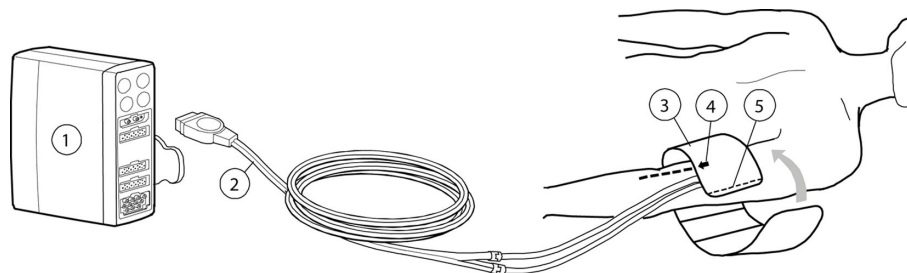

1. Module with NIBP measurement capability
2. Cuff hose
3. Cuff of correct size
4. Brachial artery arrow (printed on cuff)
5. Cuff index line (printed on cuff)

NIBP module keys

There are two NIBP related keys on the PSM:

Auto On/Off	Starts and stops automatic measurements at timed intervals.
Start Cancel	Starts a single measurement, and cancels any measurement in progress.

NOTE

You can also select **NIBP Start/NIBP Cancel** or **NIBP Auto Start/NIBP Auto Stop** from the monitor's main menu.

Preparing the NIBP patient connection

1. Select an appropriate NIBP cuff size for the patient.
2. Connect the NIBP cuff hose to the module's NIBP connector.
3. Position the NIBP cuff on the patient:
 - Place the cuff arrow over the brachial artery (or whatever artery is being used).
 - Make sure that the cuff index line falls within the range markings on the cuff.
 - Wrap the cuff around the limb.
4. Make sure that the NIBP cuff tubes are not kinked, compressed, or stretched.
5. Verify or select the correct **Init. Pressure** or **Cuff Size** from the NIBP **Setup** menu.

Checking the NIBP measurement

1. Check that the pressure values are displayed.

2. For children and when using hoses without identification with a PSM, the inflation limit must be set manually.
3. PDM and TRAM: Always select the NIBP cuff size before starting a measurement. If you are trying to start the measurement without selecting the cuff size first, the **NIBP** menu opens automatically with the **Cuff Size** list open.
4. PSM: Check that the cuff hose was detected (if cuff detection is supported).
5. PSM: Start the Venous Stasis mode and check that the pump is not restarting during the measurement. If it does, the cuff may be leaking.

NIBP measurement on screen

When a **STAT** or **Venous Stasis** mode is enabled, a time progress bar displays in the NIBP parameter window:



With **NIBP Auto** mode this may be replaced by a count down indicator. The selection of either the **Graphical** progress bar or the **Numerical** indicator is a care unit setting and it is password protected.

- **NIBP Auto**: The length of the green bars indicates the proportion of the cycling time since the last measurement while the distance between the end of the green bar and the last tick mark indicates the time remaining until the next measurement.
- **STAT** or **Venous Stasis**: The bar indicates the time that the mode will continue. **STAT** holds multiple measurements for 5 minutes, and **Venous Stasis** continues without measurements for 1 minute with infants and 2 minutes with children and adults.
- During clock synchronization, the length of the green bars indicates the difference between the cycling time and time remaining until the next measurement.

Manual NIBP measurements

Starting or stopping a single NIBP measurement from the main menu

1. Start the measurement by selecting **NIBP Start**.
2. Stop the measurement by selecting **NIBP Cancel**.

Starting or stopping a single NIBP measurement from the NIBP Setup menu

1. Select the NIBP parameter window.
2. Start the measurement by selecting **Start Manual NIBP**.
3. Stop the measurement by selecting **Cancel NIBP**.

Starting or stopping a single NIBP measurement with the PSM module key

1. Start the measurement by pressing the **Start Cancel** key.

2. Stop the measurement by pressing the **Start Cancel** key again.

Automatic NIBP measurements

Automatic NIBP measurements and monitor clock synchronization

NOTE TRAM modules do not support automatic clock synchronization.

Clock synchronization timing (cycling sync) automatically synchronizes your automatic NIBP measurement time intervals with the monitor clock. For example, if automatic measurements are initiated for five minute intervals at 4:02, the first measurement is taken immediately at 4:02. The next measurement will be taken at 4:05 (interval and clock are now synchronized). All measurements will continue at five minute intervals (i.e., 4:10, 4:15, etc.)

There will always be at least a 30 second delay between two consecutive NIBP measurements during auto cycling. If an automatic measurement completes with less than 30 seconds to the next scheduled measurement, the monitor will delay the scheduled measurement until 30 seconds have passed. The cycling synchronization is not done during these 30 seconds but it will be done after the delayed auto measurement starts.

Examples with a 5 minute cycling time:

Completion with less than 30 seconds to the next scheduled measurement	Completion after the next scheduled measurement should have started
<ul style="list-style-type: none"> • First auto measurement starts: 4:59:00 • First auto measurement completes: 4:59:40 • Second auto measurement starts: 5:00:20 (not clock synchronized) • Third auto measurement starts: 5:05:00 (clock synchronized) 	<ul style="list-style-type: none"> • First auto measurement starts: 4:59:00 • First auto measurement completes: 5:00:10 • Second auto measurement starts: 5:05:00

Setting the cycle time between NIBP measurements

To automatically measure NIBP at set time intervals, you must first set the cycle time.

1. Select the NIBP parameter window.
2. Select the cycle time from the **Cycle Time** list.

NIBP Auto mode

The **NIBP Auto** mode initiates repeated measurements for the selected **Cycle Time**. There will be at least a 30 second delay between two consecutive NIBP measurements during auto cycling.

Starting or stopping the NIBP Auto from the NIBP Setup menu

1. Select the NIBP parameter window.
2. Select **Start Cycling** for **NIBP Auto**.

3. Stop the measurement by selecting **NIBP Auto > Stop Cycling**.

Starting or stopping the NIBP Auto from the monitor's main menu

1. Select **NIBP Auto Start**.
2. Stop the measurement by selecting **NIBP Auto Stop**.

Starting or stopping the NIBP Auto with the PSM module key

1. Press the **Auto On/Off** key.
2. Stop the measurement by pressing the **Auto On/Off** key again.

STAT mode

NOTE Not available in the NICU software package.

The **STAT** mode initiates a continuous cycle of measurements for five minutes. The message **STAT** displays in the NIBP parameter window when **STAT** is started. A new NIBP measurement starts after the previous measurement completes. The amount of time between measurements varies. For PDM and PSM, it is at least four seconds for adult and child and at least eight seconds for infant. For TRAM, the delay between measurements is two seconds. The early systolic value is measured and displayed until the final result is available. After five minutes, the monitor automatically returns to the previously selected cycling interval or manual mode.

Starting or stopping a Stat NIBP measurement

You can set the NIBP measurement to continue for five consecutive minutes.

1. Select the NIBP parameter window.
2. Select **Start Stat**.
3. Stop the measurement by selecting **Stop Stat**.

Venous stasis

NOTE PSM only.

The venous stasis mode initiates inflation and holds a constant pressure in the cuff to help venous cannulation. The message **Stasis** displays in the NIBP parameter window when venous stasis mode is started. During the last 10 seconds, the **Stasis** message begins to flash to indicate the monitor is about to return to the previously selected cycling interval or manual mode. Stasis measurement pressure is controlled by the PSM internally.

Venous stasis allows you to apply continuous NIBP cuff pressure for a short period of time. The cuff inflation pressure and duration are dependent on the detected cuff or selected inflation limits.

Cuff	Pressure	Duration
Adult	80 ± 5 mmHg (10.7 ± 0.7 kPa)	2 minutes
Child	60 ± 5 mmHg (8.0 ± 0.7 kPa)	2 minutes
Infant	40 ± 5 mmHg (5.3 ± 0.7 kPa)	1 minute

Venous stasis pressure may be lower than the values above if the patient has low blood pressure. The venous stasis pressure adapts to the measured mean pressure being approximately the same as the mean pressure but always at least the following:

- **Adult:** 40 ± 5 mmHg (5.3 ± 0.7 kPa)
- **Child:** 30 ± 5 mmHg (4.0 ± 0.7 kPa)
- **Infant:** 20 ± 5 mmHg (2.7 ± 0.7 kPa)

Starting or stopping the venous stasis

NOTE PSM only.

1. Select the NIBP parameter window.
2. Select **Start Venous Stasis**.
3. Stop the venous stasis by selecting **Stop Venous Stasis**.

NIBP cuffs

NIBP cuff selection and placement

Always choose the appropriate blood pressure measurement site. In adult and child patients, the upper arm is preferred for convenience and because normative values are generally based on this site. When factors prohibit use of the upper arm, the clinician must plan patient care accordingly, taking into account the patient's cardiovascular status and the effect of an alternative site on blood pressure values, proper cuff size, and comfort.

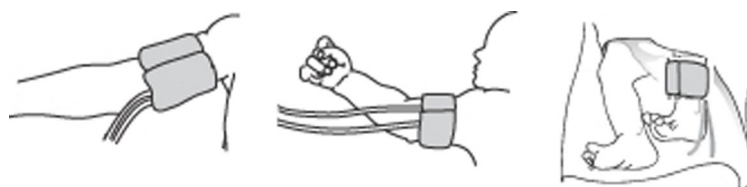

Adult and child

Infant

Always measure patient's limb and select appropriately sized cuff according to size marked on cuff or cuff packaging. When cuff sizes overlap for a specified circumference, choose the larger size cuff.

If patient is standing, sitting, or inclined, ensure that cuffed limb is supported to maintain the cuff at level of patient's heart. If the cuff is not at heart level, the difference in the measured pressure values due to hydrostatic effect must be considered.

Selecting NIBP cuff size

NOTE PDM and TRAM only.

You must first select the NIBP cuff size before starting a NIBP measurement.

1. Select the NIBP parameter window.
2. Select **Adult**, **Child**, or **Infant** from the **Cuff Size** list.

Initial NIBP cuff inflation pressure

	PDM	PSM	TRAM
Adult	135 mmHg (18 kPa)	170 mmHg (22.7 kPa)	160 mmHg (21.3 kPa)
Child	125 mmHg (16.7 kPa)	150 mmHg (20.0 kPa)	140 mmHg (18.7 kPa)
Infant	100 mmHg (13.3 kPa)	120 mmHg (16.0 kPa)	110 mmHg (14.7 kPa)

NOTE PDM and TRAM: When the **Auto Initial Inflate** setting is enabled, the initial cuff inflation pressures are dependent on the NIBP module used and selected cuff size. The initial target pressure preset can be adjusted if you desire a lower or higher initial target pressure.

Selecting the initial NIBP cuff inflation pressure

NOTE PDM and TRAM only.

You can determine the cuff inflation pressure automatically based on the cuff size.

1. Select the NIBP parameter window.
2. Select **Auto Initial Inflate**.

Setting the target NIBP inflation pressure

NOTE PDM and TRAM only.

You can manually change the target inflation pressure for the first NIBP measurement.

1. Select the NIBP parameter window.
2. Check that **Auto Initial Inflate** is not selected.
3. Select a value from the **Init. Pressure** list.

Selecting the cuff inflation limits

NOTE PSM only.

Black-colored Adult/Child cuff hoses and blue-colored Infant cuff hoses are automatically detected by the monitor and inflation limits are set accordingly. However, if the cuff hoses cannot be detected automatically, you must set the inflation limits manually. You can also select the inflation limits when the automatic detection is working.

1. Select the NIBP parameter window.
2. Select the **Setup** tab.
3. Select **Infant**, **Child**, or **Adult** from the **Inflation Limits** list.

NIBP volume and display settings

Adjusting the NIBP measurement completion tone volume

1. Select the NIBP parameter window.

2. Set the **Completed NIBP Volume**.
The lower the value, the softer the tone.

Setting the NIBP display format

1. Select the NIBP parameter window.
2. Select the format from the **Display Format** list:
 - **Sys/Dia (Mean)**: All values are shown, but the sys/dia values are shown in a bigger font.
 - **(Mean) Sys/Dia**: All values are shown, but the mean value is shown in a bigger font.

NIBP alarms

Setting NIBP alarms

1. Select the NIBP parameter window.
2. Select the **Alarms** tab.
3. Select **Systolic (SYS)**, **Mean (M)**, or **Diastolic (DIA)** pressure.
If the feature is not active, the alarm limits are greyed out. Select **Alarm On** to set the alarms.
4. Set the alarm limits.

Silenced NIBP alarms

The silence alarm behavior is different for NIBP than for any other parameter. Unlike the continuously monitored parameters, NIBP is measured periodically. As a result, silencing a physiological NIBP alarm will clear that active alarm until the next NIBP measurement is taken. If the new measurement is outside the alarm limits, the alarm is activated again.

NIBP recheck after alarm violation

NOTE PDM and PSM only.

If the NIBP value exceeds the alarm limits and the NIBP alarm priority selection is **Escalating**, a new measurement takes place automatically. If the NIBP measurement is taken manually, the recheck measurement is taken immediately after the first measurement. When the NIBP measurement is taken automatically, the recheck measurement is delayed by 30 seconds before the second measurement is taken.

NIBP measurement description

The acquisition modules use oscillometric technology to acquire NIBP. Oscillometry is the most commonly used means of indirect blood pressure measurement in automated devices. It is based on the principle that pulsatile blood flow through an artery creates oscillations of the arterial wall.

Oscillometric devices use a blood pressure cuff to sense these oscillations that appear as tiny pulsations in cuff pressure. By measuring and analyzing at various cuff

pressures, the amplitude (which changes based on the pressure within the cuff) and the frequency of these pulsations (which is dependent on the patient's heart rate), oscillometric devices can non-invasively determine blood pressure.

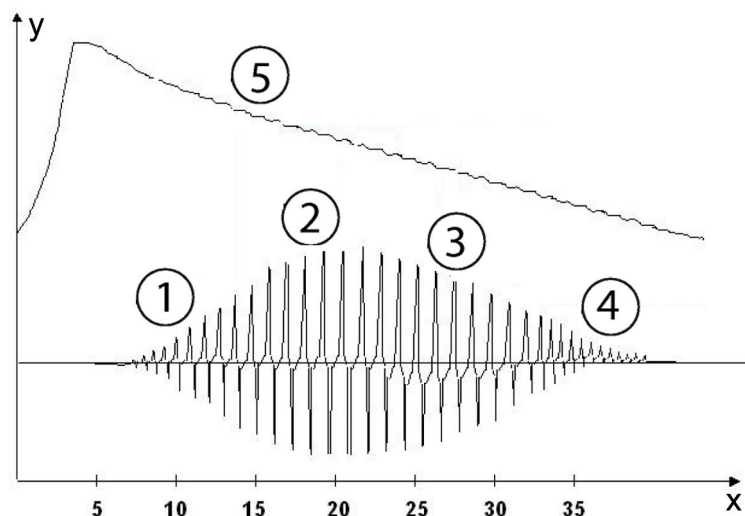

- x = Time(s)
- y = Pressures
- 1. Systolic (50%)
- 2. Mean (100%)
- 3. Diastolic (75%)
- 4. Extracted pulse wave
- 5. Cuff pressure

NIBP measurement technologies

The DINAMAP Classic technology measures the mean arterial pressure, then determines the systolic and diastolic values. The technology examines pulses from the cuff and waits for two sequential pulses equal in both frequency and amplitude. It will not deflate the cuff until it has good data. Artifact and false pulses are rejected.

The first determination initially pumps up to a target cuff pressure of 160 mmHg for adult, 140 mmHg for child or 110 mmHg for infant. The initial target pressure preset can be adjusted to a lower (or higher) initial target pressure.

PDM and TRAM use the DINAMAP Step Deflation technology. During the deflation process, the monitor measures two consecutive pulsations in cuff pressure. If their amplitude differs by an acceptably small amount and the time interval between the pulsations matches the previous time intervals, the pulsations are averaged and stored along with the corresponding cuff pressure. The cuff is then deflated to the next step (in steps of 5-10 mmHg). As the deflation occurs, oscillation waves are assessed for strength and amplitude until the maximum oscillation amplitude or MAP is obtained.

If either of the above criteria is not met, the cuff pressure is maintained until two consecutive pulsations are detected that meet the criteria. Eventually, if the cuff is maintained at one pressure step for longer than one minute or the determination time exceeds two minutes, the monitor will time out and display an error.

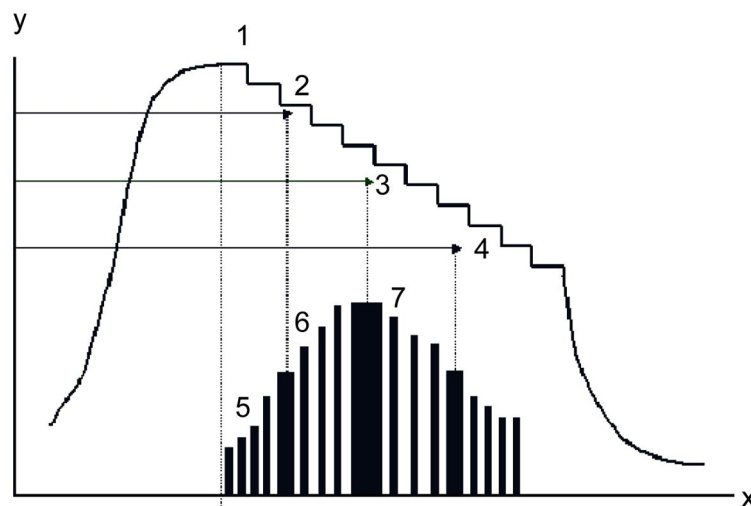

- x = Cuff pulsation waveform
- y = Cuff pressure
- 1. Cuff deflation
- 2. Systolic pressure (ratio of maximum amplitude)
- 3. Mean arterial pressure (maximum pulsation amplitude)
- 4. Diastolic pressure (ratio of maximum amplitude)
- 5. Cuff pulsations (each pulsation represents one heart beat)
- 6. Amplitude (changes based on cuff pressure)
- 7. Resulting waveform

Systolic and diastolic determinations are based on a mathematical calculation within the algorithm. The deflation mode is heart rate dependent, it is typically longer with heart rates that are slow and/or irregular.

This patented process of finding two matched pulsations of relatively equal amplitude and frequency at each step rejects artifact due to patient movement or other deviations from ideal conditions (e.g., cuff disturbances) and greatly enhances the overall accuracy of the monitor.

NOTE

NIBP values are based on the oscillometric method of non-invasive blood pressure measurement taken with a cuff on the arm of adult and child patients, and a cuff on the calf of infants. The values correspond to comparisons with intra-arterial values within ANSI/AAMI SP10 and IEC particular standards for accuracy (a mean difference of ± 5 mmHg, and a standard deviation of < 8 mmHg).

TRAM modules' NIBP technology

TRAM modules use the DINAMAP Classic algorithm. This algorithm measures the mean arterial pressure and then determines the systolic and diastolic values. The algorithm examines pulses from the cuff and waits for two sequential pulses equal in both frequency and amplitude. It will not deflate the cuff until it has good data. Artifact and false pulses are rejected.

The first determination initially pumps up to a target cuff pressure of 160 mmHg for adult, 140 mmHg for child, or 110 mmHg for infant. The initial target pressure preset can be adjusted to a lower (or higher) initial target pressure.

PDM modules' NIBP technology

PDM modules use the DINAMAP SuperSTAT technology. This technology measures the mean arterial pressure and then determines the systolic and diastolic values. However, this technology also incorporates the EK-Pro algorithm.

(Adult/child only) When ECG is monitored, SuperSTAT NIBP is able to determine blood pressure in the presence of irregular heart rhythms. At the beginning of a SuperSTAT NIBP determination, the coefficient of variation from the previous 120 ECG RR intervals is used to determine if an irregular rhythm is present.

The first determination initially pumps up to a default target cuff pressure of about 135 mmHg for adults, 125 mmHg for child, or 100 mmHg for infant. The initial target pressure preset can be adjusted if you desire a lower (or higher) initial target pressure. To allow for rapid setting of cuff pressure, the monitor will momentarily inflate to a higher pressure, then immediately deflate to the target pressure.

As a determination is taken, the pattern of the patient's oscillation size is stored as a function of pressure. In any subsequent determination, as few as four pressure steps may be necessary to complete the process. When employing fewer pressure steps, the system uses the stored information from the previous blood pressure determination to decide the best pressure steps to take. The consistency of pulse sizes are measured to tell if the oscillations taken at a step are good and if more steps are needed.

If the current blood pressure reading is similar to the previous reading, some information from the previous blood pressure may be used in the current determination. The data is constantly evaluated during a measurement to try to perform a blood pressure determination in the shortest possible time, providing greater comfort to the patient.

If it has been 16 minutes or less since the last determination and the current blood pressure is similar to the previous reading, the monitor will try to make an accelerated determination of blood pressure.

During irregular rhythms, only pulses from the current determination are used in calculating the blood pressure values. In order to ensure adequate artifact rejection capability and optimal SuperSTAT NIBP performance, several criteria used to match and qualify the oscillometric pulses at each pressure step are relaxed while supplementing the criteria with additional information from ECG.

PSM modules' NIBP technology

PSM use a technology similar to DINAMAP Classic, with the exception of cuff deflation. In this algorithm the cuff pressure is deflated continuously (linear bleed), as opposed to step deflation.

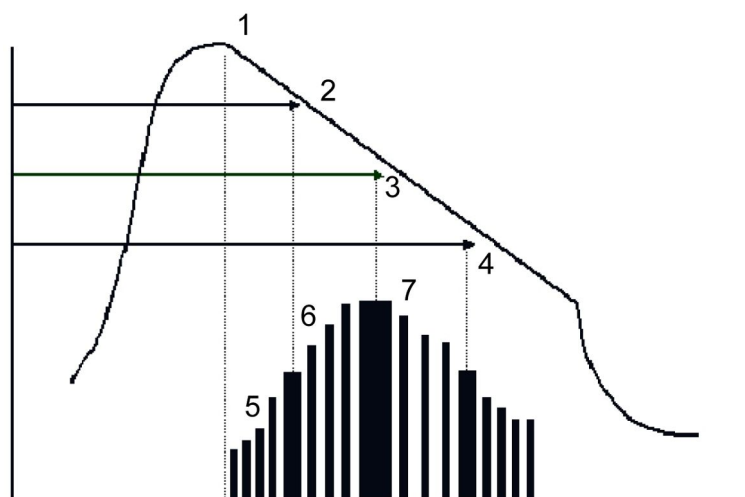

1. Cuff deflation
2. Systolic pressure (ratio of maximum amplitude)
3. Mean arterial pressure (maximum pulsation amplitude)
4. Diastolic pressure (ratio of maximum amplitude)
5. Cuff pulsations (each pulsation represents one heart beat)
6. Amplitude (changes based on cuff pressure)
7. Resulting waveform

When the measurement signal detects artifacts, the deflation is stopped until a good signal can be measured again. The cuff pressure remains at one pressure level until it gets two similar pulses before continuing to the next pressure level. It compares two sequential pulses and uses information and statistics from previous pulses.

The performance in disturbance or artifact cases is comparable to DINAMAP Classic.

The measurements do not use ECG information. The initial inflation pressure cannot be adjusted, it is determined by the patient type (adult, child or infant). The first determination initially pumps up to a target cuff pressure of 170 mmHg for adult, 150 mmHg for child or 120 mmHg for infant. After the first measurement, the inflation pressure is adjusted according to measured systolic pressure.

NIBP calibration

NIBP calibration procedure is explained in the Module Frames and Modules Technical Manual. The calibration procedure is password protected.

NIBP troubleshooting

Problem	Solution
NIBP measurement does not work or the values seem unstable.	<ul style="list-style-type: none"> • Check that the cuff tubing is not bent, stretched, compressed, or loose. • Check the cuff position and cuff tube connection. • Prevent motion artifact. • Use NIBP cuffs of correct size.
Why does the mean value display while the associated systolic and diastolic values display as - - -?	<ul style="list-style-type: none"> • Assess the patient and perform a visual inspection of the equipment to ensure system integrity. <p>The following conditions may cause the mean value to display in the NIBP parameter window while the associated systolic and diastolic values display as - - -:</p> <ul style="list-style-type: none"> • Very low systolic and diastolic amplitude fluctuations (e.g., patient in shock). • Very small difference between the mean and systolic pressure or the mean and diastolic pressure. • Loss of system integrity (e.g., loose connections or worn parts)
Why is the monitor re-inflating the cuff automatically?	<p>The cuff target pressure must be higher than the patient's systolic pressure to obtain an accurate systolic and diastolic measurement. If a systolic blood pressure cannot be found, the monitor searches for a systolic reading by re-inflating the cuff at a higher pressure. This systolic search may occur once per NIBP determination cycle. During a systolic search, the maximum cuff inflation pressure will not exceed the normal pressure range of the cuff. For more information, refer to the technical specifications.</p> <p>For PDM and PSM, the monitor may be taking a control measurement. If the measured NIBP value exceeds the alarm limits, a single low priority alarm sounds and a new measurement is automatically taken. If the new value (the control measurement) also exceeds the alarm limits the alarm priority escalates to medium. In Manual mode and STAT mode there are at least four seconds between the first measurement and the control measurement for Adult and Child cuffs, eight seconds for Infant cuffs. In Auto mode there are at least 30 seconds between the first measurement and the control measurement.</p> <p>For PSM, if Weak pulsation or Artifacts is detected, the module repeats the measurement up to three times. Assess the patient and perform a visual inspection of the equipment to ensure system integrity.</p> <p>For PSM, if cuff occlusion is detected during inflation the module might repeat the measurement. Perform a visual inspection of the equipment to ensure system integrity.</p>

Non-invasive blood pressure

12

Invasive pressures

Invasive pressures compatibility limitations

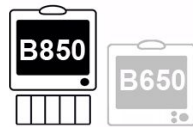

TRAM and Tram-Rac modules with the B850 only.

For detailed information regarding module, monitor, and accessory compatibility, see the supplemental information manual.

Invasive pressure safety precautions

Invasive pressure warnings

- | | |
|----------------|---|
| WARNING | All invasive procedures involve risks to the patient. Use aseptic technique. Incorrect use of the catheter can lead to vessel perforation. Follow catheter manufacturer's instructions. |
| WARNING | Make sure that no part of the patient connections touches any electrically conductive material including earth. |
| WARNING | Mechanical shock to an invasive blood pressure transducer may cause severe shifts in the zero balance and calibration, and cause erroneous readings. |
| WARNING | Repositioning the patient after a completed zeroing procedure may cause incorrect measurement values. |
| WARNING | When connecting PDM or TRAM, the loaded IP labels may affect the channel labeling of other already connected channels, and consequently also the alarm limits. |

Invasive pressure measurement limitations

- E-modules used for this measurement are not suitable for use with neonatal patients.

Invasive pressure points to note

- Depending on the invasive pressure module used, not all invasive pressure measurements and settings are available to view or change.
- Do not turn on the IABP algorithm unless a balloon pump is in use.
- If two pressure measurement modules that map to the same pressure channel are connected, the first detected pressure measurement module is assigned to the indicated pressure channel.
- A pressure channel is activated when a pressure transducer interface cable is connected to the PDM (Masimo), PDM (Nelcor), Tram 451, Tram 451N5, Tram 451M, Dual BP, BP/CO, BP, or BP/Dual Temp, or E-COP module, or when a pressure transducer is connected to the E-COPSv, E-PSMP, E-PP, E-P, or E-PT module.
- A pressure channel is deactivated when the pressure transducer interface cable is disconnected from the PDM (Masimo), PDM (Nelcor), Tram 451, Tram 451N5, Tram 451M, Dual BP, BP/CO, BP, or BP/Dual Temp, or E-COP module, or when the pressure transducer is disconnected from the or E-COPSv, E-PSMP, E-PP, E-P, or E-PT module.
- E-modules: A deactivated pressure channel does not release the assigned pressure channel. To release an assigned pressure channel, remove the module from the system.
- PCWP: Follow your care unit's policy and procedures for obtaining PCWP measurements, including balloon inflation duration.
- SPV and PPV: Measurement is reliable only when the patient is mechanically ventilated.

Invasive pressure measurement setup

Invasive pressure equipment to patient connection

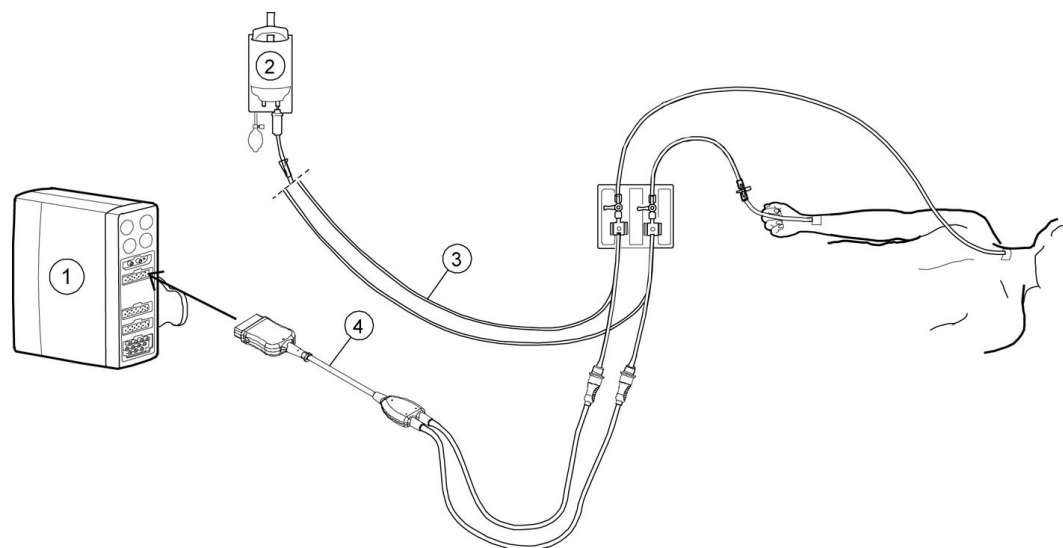

1. Module with invasive pressure measurement capability
2. Fluid bag with pressure infusor
3. Transducer setup
4. Invasive blood pressure adapter cable; single or dual cable (optional)

Invasive pressure module keys

There are invasive pressure keys on the following modules:

Module	Key	Functionality
E-modules	Zero P1 to P8	Zeros the reference for each pressure transducer individually.
PDM		Zeros the reference for all pressure transducers connected to the PDM.

Connecting the invasive pressure transducer and cable

1. Prepare the transducer kit according to the manufacturer's instructions.
2. Connect the pressure transducer to the transducer cable.
3. Remove entrapped air from within the transducer setup.
4. Connect the transducer cable to the acquisition module's invasive pressure connector.
5. Connect the transducer to the patient line.

Checking the invasive pressure measurement

1. Check that the monitor recognizes cable connections (activates the display) for all the pressure channels used and the pressure values and appropriate waveforms are displayed.
2. Make sure that all the transducers are zeroed correctly.

Invasive pressure measurement on the monitor screen

The invasive pressure channel labels are as follows:

Label	Description
<i>Art</i>	Arterial pressure
<i>ABP</i>	Arterial blood pressure
<i>Fem</i>	Femoral arterial pressure
<i>FemV</i>	Femoral venous pressure
<i>PA</i>	Pulmonary arterial pressure
<i>CVP</i>	Central venous pressure
<i>LAP</i>	Left atrial pressure
<i>RAP</i>	Right atrial pressure
<i>ICP</i>	Intracranial pressure
<i>RVP</i>	Right ventricular pressure
<i>UAC</i>	Umbilical arterial pressure
<i>UVC</i>	Umbilical venous pressure

Label	Description
P1 to P8	Non-specific pressure channel labels
NOTE	UAC and UVC invasive pressure channels are only available in the NICU software package.

Selecting the display mode for IP waveforms

You can select the invasive pressure waveforms to be shown as individual waveforms, or in a combined view.

1. Select **Monitor Setup > Screen Setup**.
2. B850 with the Double Video license: Select **Screen 1** or **Screen 2** tab.
3. Select **Upper Parameter Area**.
4. Select an option from the **Invasive Pressure Waveforms** list:
 - To view individual waveforms, select **Individual**.
 - To combine the currently displayed adjacent waveforms (2 to 4), select **Combined**. The new waveform field will use the combined height of the original fields.
 - To combine up to four waveforms in one field, select **4invP**. The new waveform field will use the height of two upper parameter windows.

Using the invasive pressure measurement

Invasive pressure measurement mapping

Invasive pressure measurements are mapped to one of eight (B850) or seven (B650) invasive pressure channels as follows:

Pressure channel	Pressure measurement source
P1	PDM (Masimo), PDM (Nellcor), TRAM 451, TRAM 451N5, TRAM 451M, E-PSMP.
P2	PDM (Masimo), PDM (Nellcor), TRAM 451, TRAM 451N5, TRAM 451M, E-PSMP.
P3	PDM (Masimo), PDM (Nellcor), TRAM 451, TRAM 451N5, TRAM 451M, .
P4	PDM (Masimo), PDM (Nellcor), TRAM 451, TRAM 451N5, TRAM 451M, .
P5	Dual BP, BP/CO, or BP/Dual Temp Tram-Rac module in Tram-Rac slot 3, or E-PP.
P6	Dual BP or BP Tram-Rac module in Tram-Rac slot 3, E-PP.
P7	Dual BP, BP/CO, or BP/Dual Temp Tram-Rac module in Tram-Rac slot 4, E-P, or E-PT.
P8	Dual BP or BP Tram-Rac module in Tram-Rac slot 4, E-COP, or E-COPSv.

Invasive pressure analog output

Invasive pressure module	Analog output signal
E-modules	P1 channel
PDM	<p>Sets the first available arterial channel (Art, ABP, Fem, UAC) for invasive pressure analog output.</p> <ul style="list-style-type: none"> • If there are no arterial channels available, the first zeroed channel will be used. • If there are no zeroed channels available, a flat line will be the output of the IP Analog output channel.
TRAM	<p>Sets first: Art, ABP, Fem, then UAC based on the channel number.</p> <ul style="list-style-type: none"> • If there are no arterial channels available, P1 will be used.
Single-parameter Tram-Rac module	<p>Sets first: Art, ABP, Fem, then UAC based on the channel number.</p> <ul style="list-style-type: none"> • If there are no arterial channels available, P1 will be used. <p>Sets P2 as the second analog output channel. Sets P3 as the third analog output channel. Sets P4 as the fourth analog output channel.</p>

About zeroing the invasive pressure transducers

- Prior to monitoring, zero transducers at the patient's phlebostatic axis. Zeroing the pressure transducers is very important for accurate pressure measurements. To avoid inaccurate measurements, you must zero the pressure transducers:
 - Before measuring invasive pressures.
 - Before initiating treatment changes reliant upon pressures data.
 - When using a new transducer or tubing.
 - After reconnecting the transducer cable to the acquisition device.
 - Whenever the patient's position is changed.
 - Whenever the pressure reading is questionable.
- Pressures can be zeroed individually by selecting **Zero** on the pressure menu or by pressing the zero key on the modules. You can zero all pressures except ICP by selecting **Zero All Pressures** on the main menu.
- You can zero all active transducers on the E-modules by pressing each **Zero P1** to **P8** keys.
- You can zero all active transducers on the PDM module by pressing the zero all  key.

NOTE

E-modules record a time stamp of the last successful zeroing for each invasive blood pressure channel.

Zeroing the invasive pressure transducers

1. Level the transducer following your care unit's policy (usually level of the phlebostatic axis).
2. Close the transducer stopcock to the patient and open the venting stopcock to air.
3. If the pressure line you are trying to zero does not have the transducer open to air, the message **Pressure Sensed** displays.
4. You can zero all connected pressure transducers simultaneously by selecting **Zero All Pressures** from the monitor's main menu or from the remote control, or you can zero a single active pressure transducer by selecting the invasive pressure parameter window > **Setup** > **Zero**.

NOTE

Zero All Pressures does not zero a connected ICP channel. The ICP channel must be zeroed separately. When the **Zero ICP separately** message displays, you can zero the ICP channel by pressing the **Zero P1 to P8** or zero all **0** module key or by selecting **Zero** from the ICP **Setup** window.

5. Check that a zero reference has been established. Watch the pressure parameter window for messages.
6. Close the venting stopcock to air and open the transducer stopcock to the patient.
7. Check that pressure numerics display on screen.

Selecting an invasive pressure channel label

One channel label can only be mapped to one channel at a time. If you select a channel label that is already mapped to another channel, the other channel's label will change to the default value.

1. Select the invasive pressure parameter window.
2. Select the **Setup** tab.
3. Select a channel label from the **Label** list.

Selecting the size of the invasive pressure waveform

1. Select the invasive pressure parameter window.
2. Select the **Setup** tab.
3. Set the waveform scale with the **Scale** arrows.

The larger the scale value, the smaller the waveform size.

Optimizing the invasive pressure waveform scale

You can select an automatic calculation for an optimized waveform size. This size will then be used for the local waveform, minitrend, and waveform printouts. Other instances (e.g., information sent to the network), will use the scale selection that is as close as possible to the upper limit of the optimized scale.

The algorithm uses the last four seconds of the waveform data to calculate the scale. If you notice a considerable change in the waveform during that time, wait for the waveform to stabilize and perform the operation again.

1. Select the invasive pressure parameter window.
2. Select the **Setup** tab.
3. Select **Optimize Scale**.

The **Scale** selection will now show the automatic limit range.

NOTE The **Optimize Scale** selection will not automatically change to match the waveform, you will always have to select it manually every time.

Selecting the hemodynamic waveform sweep speed

NOTE This setting adjusts the waveform speed for all of the hemodynamic parameters.

1. Select the invasive pressure parameter window.
2. Select the **Setup** tab.
3. Select a numeric value from the **Hemodynamic Sweep Speed** list.

The smaller the value, the slower the sweep speed.

Selecting the invasive pressure noise reduction filter

NOTE If arterial pressure is used to trigger the intra-aortic balloon pump, use the 40 Hz pressure filter.

1. Select the invasive pressure parameter window.
2. Select the **Setup** tab.
3. Select a numeric value from the **Filter Hz** list.

The smaller the filter value, the greater the degree of filtering that occurs.

Selecting the displayed invasive pressure format

You can choose to display systolic, diastolic or mean pressure values in different formats.

1. Select the invasive pressure parameter window.
2. Select the **Setup** tab.
3. Select the format from the **Parameter Format** list:
 - **Mean only:** Only the mean value is shown.
 - **Sys/Dia (Mean):** All values are shown, but the sys/dia values are shown in a bigger font.
 - **(Mean) Sys/Dia:** All values are shown, but the mean value is shown in a bigger font.
 - **Sys/Dia /Mean:** All values are shown in an equally big font.

Selecting invasive pressure as the primary heart rate source

The primary heart rate can be calculated from the ECG leads, SpO₂ measurement, or invasive pressure waveform.

NOTE This setting adjusts the primary heart rate source for all of the hemodynamic parameters.

NOTE This setting is available for **Art**, **ABP**, **Fem**, or **UAC** invasive pressure channels only. **UAC** is only available in the NICU software package.

NOTE **HR Alarms** must be configured as **Single** to enable invasive pressure as the primary heart rate source.

1. Select the invasive pressure parameter window.
2. Select the **Setup** tab.
3. Select the heart rate source from the **Primary HR Source** list.

Variable beat tone

You can configure a variable beat tone through **Monitor Setup > Default Setup > Care Unit Settings > Parameters > Variable Beat Tone**. This setting is password protected.

If it set to **All beat sources**, the SpO₂ saturation affects all beep sounds including ECG and IP when the SpO₂ measurement is available: beep frequency changes according to increasing and decreasing SpO₂ values. If the setting is set to **Only SpO₂**, other beep sounds are not affected by the changing SpO₂ values.

For more information, see the supplemental information manual.

Selecting the ventilation mode

NOTE E-modules only.

This setting affects the respiration filter.

1. Select the invasive pressure parameter window.
2. Select the label (**P2**, **P5**, **P6**, **P7**, **P8**, **CVP**, **FemV**, **PA**, **RAP**, **RVP**, **LAP**).
3. Select **Ventilation Mode > Spontaneous** or **Controlled**.

Showing the pulse rate in the invasive pressure parameter window

NOTE This setting is available for **Art**, **ABP**, **Fem**, or **UAC** invasive pressure channels only.

1. Select the invasive pressure parameter window.
2. Select the **Setup** tab.
3. Select **Show Pulse Rate**.

Showing the CPP value in the ICP parameter window

A valid mean arterial pressure is required to compute the cerebral perfusion pressure (CPP) value.

1. Select the invasive pressure parameter window.
2. Select the **Setup** tab.

3. Select **Show CPP**.

Selecting Smart BP

NOTE PDM, TRAM and Tram-Rac modules only. **Art, ABP**, and **Fem** invasive pressure channels only.

Smart BP is an algorithm that temporarily deactivates the arterial and femoral alarms when it detects the zeroing of a transducer, fast flushing of the system, or blood draws. The message **Artifact** displays during the alarm deactivation. When pulsatile pressure returns and 15-20 beats are detected, numerics are displayed and alarms are reactivated.

1. Select the invasive pressure parameter window.
2. Select the **Advanced** tab.
3. Select **Smart BP**.

Compensating for intra-aortic balloon pump (IABP) waveform irregularities

WARNING — INCORRECT PULSE RATE — Be sure to turn off the IABP setting when the cardiac assist device is no longer used. Failure to do so could result in incorrect pulse rate readings.

CAUTION — PATIENT HAZARD — If you choose to trigger the balloon pump from the monitor, contact the balloon pump manufacturer directly for interface requirements, as they vary among manufacturers. Some trigger modes on certain balloon pump devices may not be compatible with the GE analog output signal, and use may contribute to patient injury or sub-optimal pumping results.

NOTE PDM, TRAM, and Tram-Rac modules only. **Art, ABP**, and **Fem** invasive pressure channels only.

1. Select the invasive pressure parameter window.
2. Select the **Advanced** tab.
3. Select **IABP On**.
IABP now displays in the invasive pressure channel parameter window.

Selecting the invasive pressure response time

NOTE E-modules only.

1. Select the invasive pressure parameter window.
2. Select the **Setup** tab.
3. Select **Normal** or **B-to-B** (beat-to-beat) from the **Response** list.

Using the IP channel standby

If you wish to prepare and zero a channel beforehand, you can use the channel standby.

1. Select the invasive pressure parameter window.
2. Select the **Setup** tab.
3. Select **Standby P1** to **Standby P8** (text changes according to the channel).
Channel alarms and measurement are disabled until **Activate P1** to **Activate P8** is selected.

Using the invasive pressure waveform cursor

You can display an invasive pressure waveform cursor for the selected invasive pressure channel. The cursor is selectable when a pressure waveform channel is active and using the selected pressure channel.

Up to ten pressure points can be saved and displayed. The oldest value, displayed at the top of the list, is discarded in order to save the newest value.

1. Select the invasive pressure parameter window.
2. Select the **Setup** tab > **Cursor**.
3. Select **Show Cursor**.
4. You can move the cursor to specific points with the arrows.
5. To save the pressure value at the cursor point, select **Save**.
6. To stop showing the cursor, deselect **Show Cursor**.

Setting an arterial invasive pressure disconnection alarm

You can set an additional alarm to activate if the mean pressure falls below 10 mmHg (1.33 kPa). The arterial disconnection alarm also applies to channels **ABP**, **Fem**, and **UAC**.

1. Select the invasive pressure parameter window.
2. Select the **Advanced** tab.
3. Select **Arterial Disconnect**.

Setting invasive pressure alarm limits

1. Select the invasive pressure parameter window.
2. Select the desired alarms setting:
 - **x Alarms** (e.g., **Art Alarms**): Settings for the selected invasive pressure channel.
 - **HR Alarms**: Settings when the heart rate alarms are from a single source.
 - **PR(x) Alarms** (e.g., **PR(Art) Alarms**): Settings when the heart rate alarms are calculated from multiple sources.

NOTE If a feature is not active, the alarm limits are greyed out. You can set them on by selecting **Alarm On**.

3. Set the alarm limits.

Invasive pressures alarm priorities

You can select priorities for the **Art high/low**, **ABP high/low**, **Fem high/low**, **FemV high/low**, **CVP high/low**, **PA high/low**, **RAP high/low**, **RVP high/low**, **LAP high/low**, **ICP high/low**, **CPP high/low**, and **P1 high/low** to **P8 high/low** alarms through **Alarm Setup > Alarm Priorities > Invasive Pressures**. The choices are **Low**, **Medium**, **High**, and **Escalating**.

Systolic pressure variation and pulse pressure variation

Systolic pressure variation (SPV) and pulse pressure variation (PPV) can provide useful information for example when assessing the effects of fluid therapy on the cardiac output of a patient. A parameter window with both SPV and PPV values appears on the display provided that SPV has been selected to the screen and the arterial site selected as the SPV source is active.

The SPV and PPV measurement is automatic, and SPV can also be taken manually.

With the NICU software package, no automatic SPV or PPV are available, only the manual SPV can be used.

NOTE The SPV and PPV measurements are reliable for mechanically ventilated patients with no arrhythmias, and when the arterial site selected as the SPV source is providing reliable readings.

Changing the SPV source

1. Select the invasive pressure parameter window.
2. Select **Art**, **ABP**, **Fem** or **UAC**.
3. Select the **Setup** tab.
4. Select **SPV Source > Art**, **ABP**, **Fem**, or **UAC**. You can also turn off the measurement by selecting **Off** (default).

Measuring SPV manually

The SPV can also be measured manually. In addition to ECG1 and the selected SPV source, one of the following parameters is displayed in this order: Paw, CO₂, Resp. You can set the SPV cursors to define the difference between the minimum and maximum systolic peak pressures.

1. Select the SPV and PPV parameter window.
2. Select **Freeze Waveforms**.
3. Adjust the cursors with the arrow selectors.

NOTE You must always adjust the cursors in the NICU software package. The monitor does not suggest any cursor positions as there is no automatic SPV measurement in this software package.

4. You can save these cursors by selecting **Save**.

This will restart the waveforms. If you do not want to save the cursors, select **Restart Waveforms**.

NOTE You can also use the **Optimize Scale** function in the invasive pressure **Setup** menu to set the scale for manual SVP measurement.

PA catheter insertion

The catheter insertion mode optimizes and enlarges the PA waveform field during SWAN-GANZ thermodilution catheter insertion. Waveforms display at a rate of 12.5 mm/s and appear in the following display order: **ECG1, Art, CVP, PA**.

The arterial priority order is: **Art, ABP, Fem**, or **UAC**.

Selecting the PA catheter insertion mode

1. Select the PA invasive pressure parameter window.
2. Select **Zero** to zero the invasive pressure channel.
3. Select **Catheter Insertion**.

The pressure scale settings in the **Catheter Insertion** window follow the scale settings in the **Setup** menu.

4. Select the procedure:
 - To start an SvO₂ procedure, select **SvO2**.
 - To start a pulmonary capillary wedge pressure procedure, select **Wedge**.
 - To start a cardiac output procedure, select **C.O**.

In the **Catheter Insertion** menu, you can also freeze or restart the waveforms, and print them:

- To freeze the moving waveforms, select **Freeze Waveforms**. At any time, select **Restart Waveforms** to restart the waveforms.
- To print the catheter insertion waveforms, select **Print Waveforms**. At any time, select **Stop Printing** or **Cancel Printing** to stop printing the waveforms.

Pulmonary capillary wedge pressure (PCWP) measurement

You can obtain a PA wedge measurement (PCWP) manually or with the automated wedge program. The manual measurement mode allows you to manually determine the PCWP value. The automated wedge program displays on-screen messages to inflate or deflate the catheter balloon. In either mode, the wedge algorithm then determines the PCWP value. You can confirm this value or adjust the measurement with the provided cursor.

NOTE E-modules always use the automated wedge program to determine the PCWP value.

NOTE PDM and TRAM may use either the automated wedge program or a manual measurement to determine the PCWP value. The PA wedge algorithm requires a 30% change in waveform size between the PA and Wedge waveform in order to initiate the automated program. If the algorithm fails to distinguish between the waveforms, you should use the manual measurement mode.

Showing the PCWP value in the PA window

1. Select the PA invasive pressure parameter window.
2. Select the **Setup** tab.
3. Select **Show PCWP**.

Taking a manual PA wedge measurement

NOTE PDM and TRAM only.

1. Select the PA invasive pressure parameter window.
2. Select the **Setup** tab.
3. Select **Wedge**.
4. Select **Mode: Manual**.
5. To record a realtime PA wedge waveform during analysis, select **Print PA Waveform**. To stop printing, select **Stop Printing** or **Cancel Printing**.
6. Inflate the catheter balloon when the **Manually "Freeze / Adjust" when ready** message displays.
7. Select **Freeze/Adjust** once the PCWP waveform is displayed. The **Wedge Complete** message displays.
8. Deflate the balloon.
9. To adjust the PA wedge value, move the cursor up or down with the **PCWP / Cursor** arrows.
10. To save the PCWP value, select **Confirm Wedge**.
The saved PA wedge value displays in the parameter window and is stored in trends and hemodynamic calculations.
11. To print a PCWP report, select **Print PA Report**. To stop printing, select **Stop Printing** or **Cancel Printing**.

The PA wedge report contains 20 seconds of waveform data displayed at a waveform speed of 12.5 mm/s.

Taking an automated PA wedge measurement

1. Select the PA invasive pressure parameter window.
2. Select the **Setup** tab.
3. Select **Wedge**.
4. Select **Mode: Auto**.

5. To record a realtime PA wedge waveform during analysis, select **Print PA Waveform**. To stop printing, select **Stop Printing** or **Cancel Printing**.
6. Inflate the catheter balloon when the **Inflate the Balloon** message displays.

NOTE PDM and TRAM only: Once the PCWP waveform is detected, the **Wedge processing** message displays.

After 10 seconds, the automated wedge program displays the **Deflate the balloon**, followed by the **Wedge Complete** message.

7. To adjust the PA wedge value, move the cursor up or down with the **PCWP / Cursor** arrows.
8. To save the PCWP value, select **Confirm Wedge**.
The saved PA wedge value displays in the parameter window and is stored in trends and the hemodynamic calculations.
9. To print a PCWP report, select **Print PA Report**. To stop printing, select **Print Waveforms** or **Cancel Printing**.
The PA wedge report contains 20 seconds of waveform data displayed at a waveform speed of 12.5 mm/s.

Starting a new PA wedge measurement

You can clear the current wedge measurement and start a new one:

1. Select PA invasive pressure parameter window.
2. Select **Setup**.
3. Select **Wedge**.
4. Select **Restart Wedge**.

Other selections in the **Wedge** menu

There are also two other selections in the **Wedge** menu:

- **C.O.:** This selection will open the C.O. **Setup** menu.
- **Calculations:** This selection will open the **Hemo** calculations menu.

Calibrating the invasive pressure measurement with PDM and TRAM

1. Connect all invasive pressure transducers being tested to the module.
2. Select **Monitor Setup > IP Calibration**.
3. Select the pressure site to test.
4. Increase or decrease the pressure to adjust the displayed pressure to a known calibration factor and select **Confirm**.
5. Repeat for each pressure site as needed.
6. Select **Previous Menu > Close**.

Invasive pressure calibration with E-modules

The invasive pressure calibration with E-modules requires specific tools and setup. For detailed instructions, see the Module Frames and Modules Technical Manual.

Invasive pressure practicalities

Invasive pressure parameters

The measured invasive pressure parameters are systolic, diastolic, and mean. Pulse rate can be monitored with any arterial site. PCWP can also be measured for a PA site. CPP is a calculated value that requires a valid ICP value and a valid arterial site value. In addition, also SPV and PPV can be measured.

With the B850 you can monitor up to eight pressures, and with the B650 you can monitor up to seven pressures.

The following table lists the available site names and displayed values:

Site	Site name	PDM and TRAM, displayed values	E-modules, displayed values
General site name for the specific invasive pressure channels 1 to 8	P1 to P8	Mean	Systolic, diastolic, mean
Arterial	Art	Pulse rate, systolic, diastolic, mean	Pulse rate, systolic, diastolic, mean
Arterial blood	ABP	Pulse rate, systolic, diastolic, mean	Pulse rate, systolic, diastolic, mean
Central venous	CVP	Mean	Systolic, diastolic, mean
Femoral arterial	Fem	Pulse rate, systolic, diastolic, mean	Pulse rate, systolic, diastolic, mean
Femoral venous	FemV	Mean	Systolic, diastolic, mean
Intracranial	ICP	Mean	Systolic, diastolic, mean
Left atrial	LAP	Mean	Systolic, diastolic, mean
Pulmonary artery	PA	Systolic, diastolic, mean	Systolic, diastolic, mean
Right atrial	RAP	Mean	Systolic, diastolic, mean
Right ventricular	RVP	Mean	Systolic, diastolic, mean
Umbilical artery catheter*	UAC	Pulse rate, systolic, diastolic, mean	Not supported.
Umbilical venous catheter*	UVC	Mean	Not supported.

* PDM and TRAM with NICU software package only.

Intra-aortic balloon pump

NOTE

PDM, TRAM, and Tram-Rac only. Not available in the NICU software package.

GE recommends that the signal source used to trigger an IABP should be the intra-aortic balloon pump itself. This ensures that the trigger signal is compatible with all modes of the IABP. An extra set of ECG electrodes or an additional connection from the arterial line can be connected to the monitor to produce waveforms on the monitor's display for consolidated viewing.

When using the monitor for triggering, the IABP triggers off the PDM or TRAM module's Defib Sync ports and uses the first zeroed arterial invasive pressure channel. If the intra-aortic balloon pump triggers off arterial pressure, the analog output defaults to the numerically first zeroed arterial pressure: **Art**, **Fem**, or **UAC**. If no arterial pressure is available, the numerically first zeroed pressure is used.

Triggering intra-aortic balloon pumps

NOTE

If you choose to use the monitor for triggering, use the following instructions. Failure to follow these instructions may result in an incompatible analog output signal, which may contribute to patient injury.

1. Contact the balloon pump manufacturer for interface requirements. See the technical specifications for the ECG analog output delay specification for the acquisition device.
2. Connect a compatible analog output cable to the monitor through the PDM or TRAM module's Defib Sync connector.
3. Adjust the invasive pressure filter. If arterial pressure is used to trigger the balloon pump, use the 40 Hz pressure filter.
4. Primary displayed ECG lead: If the balloon pump triggers off the R wave of the ECG, review the patient's ECG leads and place the one with the greatest amplitude in the top (primary) position on the monitor display.
5. Pacemaker detection: If the patient has a pacemaker, be sure the pacemaker detection is turned on. Failure to turn pacemaker detection on may cause poor beat detection, which may result in inadequate triggering of the balloon pump.

Effects of IABP on displayed values

Displayed pressure values are affected by the intra-aortic balloon pump. The IABP program displays three values, for example 150/45 (98). The first value is the systolic value, the second is the diastolic value, and the third is the mean value. The displayed numeric values are indicating a rapidly varying waveform generated during IABP treatment and do not always reflect a true arterial blood pressure.

For accuracy and reliability, always combine two or more of the recommended methods for reading arterial and/or femoral blood pressure:

- The IABP waveform displayed on the screen (use scales for evaluation),
- A printed copy of the waveform (use scales for evaluation),
- The display on the balloon pump device, if available.

Since there are a number of points along the IABP waveform that could be the displayed value, it is important to know which points the program uses. The values displayed will differ depending on the timing of the pump.

1:1 or 1:2 timing

Diastolic numerics: The displayed diastole always equals the balloon end diastole.

Systolic numerics:

- When the augmented diastole is greater than the patient systole, the displayed systole equals the augmented diastole.

Art 134/63

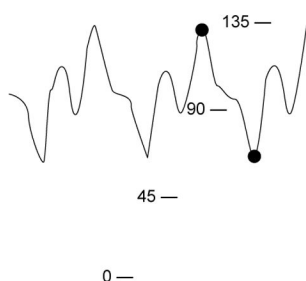

- When the patient systole is greater than the augmented diastole, the displayed systole equals the patient systole.

Art 160/45

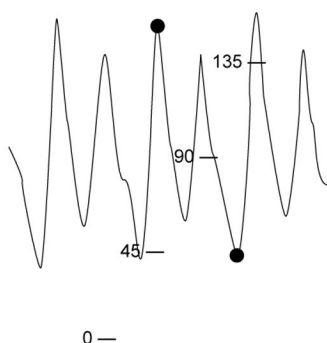

1:3 or more timing

Diastolic numerics: The displayed diastole switches between the balloon end diastole and the patient end diastole.

Systolic numerics: The displayed systolic numerics switch between the augmented diastole and patient systole.

Invasive pressures

Displayed values will switch between: Art 123/51 (●) and Art 100/60 (○)

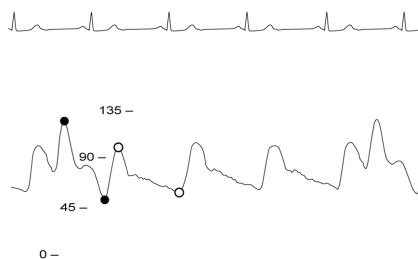

Invasive pressure troubleshooting

Problem	Solution
Artifact detected and the Smart BP option is turned on.	<ul style="list-style-type: none"> • Check the patient. • Reposition the catheter. • Zero the transducer. • If problem persists, turn off the Smart BP option. • If the Smart BP option is turned off, use the audio pause feature before drawing blood and before zeroing to reduce nuisance alarms.
Invasive pressure readings seem unstable.	<ul style="list-style-type: none"> • Make sure there are no air bubbles in the transducer systems. • Flush and zero. • Place the transducer on the patient's phlebostatic axis.
---/--- (80) Systolic and diastolic pressure values do not display.	<p>This may be due to the Smart BP option detecting artifact. When artifacts are detected, only Mean values are displayed.</p> <ul style="list-style-type: none"> • Check the patient. • Turn off the Smart BP if required.
Invasive pressure waveform is displayed but no numeric values are displayed.	<ul style="list-style-type: none"> • Zero the channel. Invasive pressure numeric values are displayed only for successfully zeroed channels.
Zeroing of invasive pressure channel(s) fails.	<ul style="list-style-type: none"> • Ensure that the channels are open to air.
The channel standby is not selectable, or it is terminated without the user giving the activation request.	<p>If the pressures remain between 10 mmHg and 250 mmHg for 10 seconds or more, the selection is disabled or the standby is terminated.</p>

Problem	Solution
<p>The measurement values in the SPV and PPV parameter window are not displayed.</p>	<ul style="list-style-type: none"> • Ensure that there are no arrhythmias present. • Check that the correct arterial site has been selected as the SPV source. • If you are using the SPV measurement in the NICU software package, only manual measurement is shown. • The algorithm requires at least three pulse beats per each respiration cycle and when this is not true, the values are not shown. Try using manual measurement.
<p>Why are displayed pressure values different than expected?</p>	<ul style="list-style-type: none"> • Check the patient. Values could be valid, the patient could be lying on the tubing, or the tubing could be kinked. • Check tubing for bubbles. • Remove excess tubing. • Check phlebostatic axis placement of transducer. • Rezero pressure. • If patient is on IABP, verify that the monitor's IABP program is turned on. If necessary, turn it on.
<p>Why are the arterial, non-invasive (oscillometric), and auscultated blood pressure readings indicating different values?</p>	<p>The three measurement methods use different technologies. Auscultation and oscillometric are both indirect methods of measuring blood pressure. In auscultation, changes in arterial sounds during cuff deflation are related to systolic and diastolic pressure. With oscillometric measurement, changes in measured pressure oscillations during cuff deflation are related to systolic, mean and diastolic pressures. Changes in the vascular tone of the arterial system can cause these two indirect methods to differ from one another and from direct arterial pressure measurements.</p> <p>Invasive arterial blood pressure is a direct method of measuring blood pressure. Differences between direct and indirect blood pressure measurements are expected. These differences occur because direct methods measure pressure and indirect methods measure flow. In addition, differences occur because the measurement location is not the same (e.g., brachial artery for NIBP vs. radial artery for invasive arterial pressure monitoring).</p>

Invasive pressures

Problem	Solution
Why is the monitor alarming arterial disconnect?	<ul style="list-style-type: none"> • Check the patient immediately in the event the catheter has been dislodged. • If the arterial disconnect alarm is turned on and the mean pressure falls below 10 mmHg, the monitor alarms. When zeroing a pressure line, start the zeroing process within 8 seconds. After that time the disconnect alarm is activated. • If zeroing, close the stopcock. Once the monitor detects the return of waveform and numeric data, the alarm will reset.
Why can't the monitor detect PA wedge?	<p>The monitor must detect a 30% decrease in waveform amplitude to initiate a wedge.</p> <ul style="list-style-type: none"> • Use the manual method for PA wedge measurement.
Why is the monitor displaying a message indicating that it is processing the wedge when the balloon has not been inflated?	<ul style="list-style-type: none"> • Begin wedge processing again. If a wedge is again detected due to respiratory artifact on the PA waveform, use the manual method for wedge measurement.
Why is monitor displaying the Deflate the balloon message after the balloon was inflated?	<p>The monitor must detect a 30% decrease in waveform amplitude to initiate a wedge. If the waveform does not change accordingly, the message will continue to be displayed.</p> <ul style="list-style-type: none"> • Use the manual method for PA wedge measurement.
Why is the displayed wedge measurement different than expected?	<ul style="list-style-type: none"> • Repeat the wedge measurement, allowing a minimum of three respiratory cycles of data. • Verify end-expiration using the respiratory waveform on the display and observing the patient's breathing pattern. Vertical cursors help to identify the end-expiration and align it with the PA pressure waveform. • Adjust the PA wedge cursor to the end-expiratory wedge value if necessary.
Why is there a flashing heart icon displayed next to the PR value in the corresponding parameter window?	<p>Art, ABP, Fem, or UAC has been selected as the Beat Source in the ECG or SpO2 menu. No action is required.</p>

13

Temperature

Temperature compatibility limitations

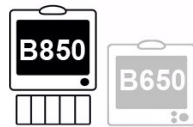

TRAM and Tram-Rac modules with the B850 only.

For detailed information regarding module, monitor, and accessory compatibility, see the supplemental information manual.

Temperature safety precautions

Temperature warnings

WARNING

When using an electrosurgery unit, note that the measurement cables do not incorporate means to protect against burns in case of a defective ESU return electrode. To avoid burns at the monitor measurement sites, ensure the following:

- Proper contact of the ESU return electrode to the patient.
- ESU return electrode near the operating area.
- Measurement electrodes, leadwires and probes far from the surgical site and the ESU return electrode.

WARNING

When using a dual temperature cable, make sure to turn the cable's selection switch to the correct position (400).

WARNING

The response time of the temperature measurement system when used with the Esophageal stethoscope with temperature probe accessory exceeds 150 seconds for probe sizes 18Fr and 24Fr.

Temperature measurement limitations

E-modules are not suitable for use with neonatal patients.

Temperature points to note

- Use only GE approved temperature accessories.

- For more detailed information regarding the temperature probes, refer to their own instructions for use.
- Depending on the temperature module used, not all temperature measurements and settings are available to view or change.
- The temperature measurement uses direct mode. Displayed temperature values represent the probe temperature of the measurement site on the patient.
- If two temperature measurement modules that map to the same temperature channel are connected, the first detected temperature measurement module is assigned to the indicated temperature channel. When this occurs, a technical alarm indicating identical modules is generated.
- A temperature channel is activated when the module detects a temperature probe.
- A temperature channel is deactivated when a temperature probe is detached from the module.
- A deactivated temperature channel does not release the assigned temperature channel. To release an assigned temperature channel, remove the module from the system.

Temperature measurement setup

Temperature equipment to patient connection

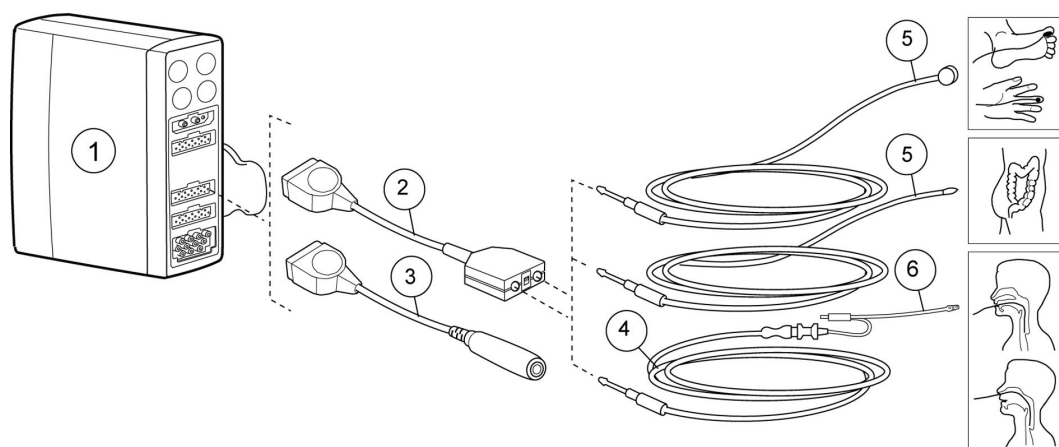

1. Module with temperature measurement capability
2. Dual temperature cable
3. Single temperature cable
4. Temperature interconnect cable for disposable temperature probes
5. Reusable temperature probe
6. Disposable temperature probe

Preparing the patient for temperature measurement

1. Follow the manufacturer's instructions for probe application and instructions.
2. Connect the single or dual temperature cable to the acquisition module connector.

Checking the temperature measurement

1. Check that the temperature value is displayed when the probe is connected to a single or dual temperature cable.

Temperature measurement on the monitor screen

Up to four temperature measuring sites can be simultaneously measured and monitored (five sites when monitoring Tblood). Temperature monitoring provides numerics only. No waveform is generated or displayed.

NOTE A maximum of six user-defined measuring site label names can be configured. See the supplemental information manual for details.

The default temperature measuring site labels are as follows:

T1, T2 = general label	Skin = skin
T3, T4 = general label	AirW = airway
Eso = esophageal	Room = room
Naso = nasal	Myo = myocardial
Tymp = tympanic	Core = core
Rect = rectal	Surf = surface
Axil = axillary	Blad = bladder

Using the temperature measurement

Temperature mappings

Temperature measurements are mapped to one of five temperature channels as follows:

Temperature channel	Measurement source, B850	Measurement source, B650
T1	PDM (Masimo), PDM (Nellcor), TRAM 451, TRAM 451N5, TRAM 451M, TRAM 851, TRAM 851N5, TRAM 851M, PSM.	PDM (Masimo), PDM (Nellcor), PSM.
T2	PDM (Masimo), PDM (Nellcor), TRAM 451, TRAM 451N5, TRAM 451M, TRAM 851, TRAM 851N5, TRAM 851M, PSM.	PDM (Masimo), PDM (Nellcor), PSM.
T3	E-PT module	E-PT module

Temperature channel	Measurement source, B850	Measurement source, B650
<i>T4</i>	E-PT module	E-PT module
<i>Tblood</i>	PDM (Masimo), PDM (Nellcor), TRAM 451, TRAM 451N5, TRAM 451M, TRAM 851, TRAM 851N5, TRAM 851M, E-COP, or E-COPsv module or Unity ID.	PDM (Masimo), PDM (Nellcor), E-COP, or E-COPsv module or Unity ID.

Starting the temperature measurement

Connect the temperature probe to start the measurement. If the parameter window displays **Off** in the value field:

1. Select the temperature parameter window.
2. Confirm that **Measurement > On** is selected.

Changing the temperature site label

1. Select the temperature parameter window.
2. Choose a site label from the **Label** list.

NOTE In addition to the default channel labels, you can configure up to six user-defined channel labels in the care unit settings. See the supplemental information manual for details.

Displaying the delta value between two temperature channels

NOTE This selection is available when two temperatures are displayed in the same temperature parameter window.

1. Select the temperature parameter window.
2. Select **Show Tx-Ty** (e.g., **T2-T1**).

Setting temperature alarms

1. Select the temperature parameter window.
2. Select **Alarms**.
3. Choose a temperature channel or temperature delta.

NOTE If the feature is not active, the alarm limits are greyed out. Select **Alarm On** to set the alarms.

4. Set the alarm limits.

NOTE The high limit alarm setting for delta values is also adjustable.

NOTE If the setting of an alarm limit has been disabled during configuration, the setting is marked with a lock symbol.

Stopping the temperature measurement

1. Select the temperature parameter window.
2. Select **Measurement > Off**.

Temperature practicalities

- Each temperature label can be changed to reflect the temperature measurement site.
- Individual temperature sites can be turned off.
- **Tblood** is obtained from a pulmonary artery catheter.
- The difference between two temperature sites can be calculated and displayed.
- The dual temperature cable allows a two-channel measurement. The temperature cable switch can be set to 400 or 700 depending on the type of probe used. Since only 400 is supported, make sure that you turn the switch to this position.
- The signal input is a high-insulation port to ensure patient safety and to protect the device during defibrillation and electrosurgery.
- The monitor automatically calibrates the temperature measurements at startup: every 10 minutes for PSM, and every minute for PDM and TRAM.

Temperature troubleshooting

Problem	Solution
Temperature measurement fails	<ul style="list-style-type: none"> • Check that the probe adapter is properly connected to the acquisition module. • Check that the probe is properly connected to the probe adapter. • Check that you are using the correct probe for the anatomical location being monitored • Use a probe that is compatible with your system. • Try using a known good probe in case the sensor is damaged. • Check that the acquisition module is properly connected to the monitor. • Check the patient connection. • Check that there are not two identical measurement modules in the system. • Contact service if the problem continues.

Temperature

Cardiac output

C.O. safety precautions

C.O. warnings

- WARNING** All invasive procedures involve risks to the patient. Use aseptic technique. Incorrect use of the catheter can lead to vessel perforation. Follow catheter manufacturer's instructions.
- WARNING** When using an electrosurgery unit, note that the measurement cables do not incorporate means to protect against burns in case of a defective ESU return electrode. To avoid burns at the monitor measurement sites, ensure the following:
- Proper contact of the ESU return electrode to the patient.
 - ESU return electrode near the operating area.
 - Measurement electrodes, leadwires and probes far from the surgical site and the ESU return electrode.
- WARNING** The cardiac output measurement results may be erroneous during electrosurgery.
- WARNING** During atrial fibrillation the C.O./CCO readings may be erroneous.

C.O./CCO cautions

- CAUTION** The C.O. time stamp indicates the time at which the C.O. value was received by the monitor from the connected device. In cases when the C.O. device is disconnected and then reconnected to the Unity Network Interface Device (ID), the time stamp may not indicate the actual time of the reading.

C.O. measurement limitations

- E-modules used for this measurement are not suitable for use with neonatal patients.

C.O. points to note

- Cardiac output measurements from the PDM and TRAM require a C.O. license.

- The C.O. connector cables are module-specific and can only be used with the appropriate C.O. module.
For more information, see the supplemental information manual.
- The patient's height and weight values are required for determining Cardiac Index (C.I.).
- E-modules only: Predefined catheters are already configured for a right ventricular ejection fraction (REF) measurement, but user-defined catheters must be configured to support it. Catheters that show up in the selection list can be added or deleted through **Care Unit Settings > Parameters > Catheters**, and these settings are password protected.
- Blood temperature measurement, T_{blood}, is provided from any supported acquisition module that provides C.O. measurements. The Unity Network Interface Device (ID) can only be used if no other acquisition module provides C.O.
- Depending on the module used, not all cardiac output measurements and settings are available to view or change.

C.O. measurement setup

C.O. equipment to patient connection with an in-line probe

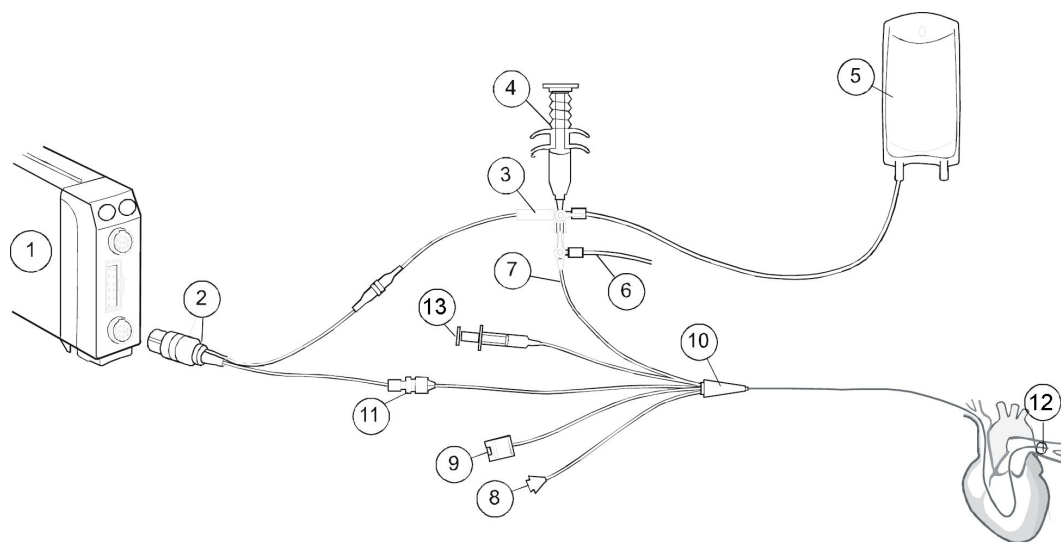

1. Module with C.O. measurement capability
2. Cardiac output cable
3. In-line injectate probe
4. Injectate syringe
5. Injectate solution
6. CVP line to IP transducer or fluid infuser
7. Proximal injectate port
8. PA distal port
9. Optical module connector (used for SvO₂ measurement)
10. Swan-Ganz thermodilution catheter

11. Thermistor connector
12. Balloon
13. Balloon inflation valve

C.O. equipment to patient connection with a bath probe

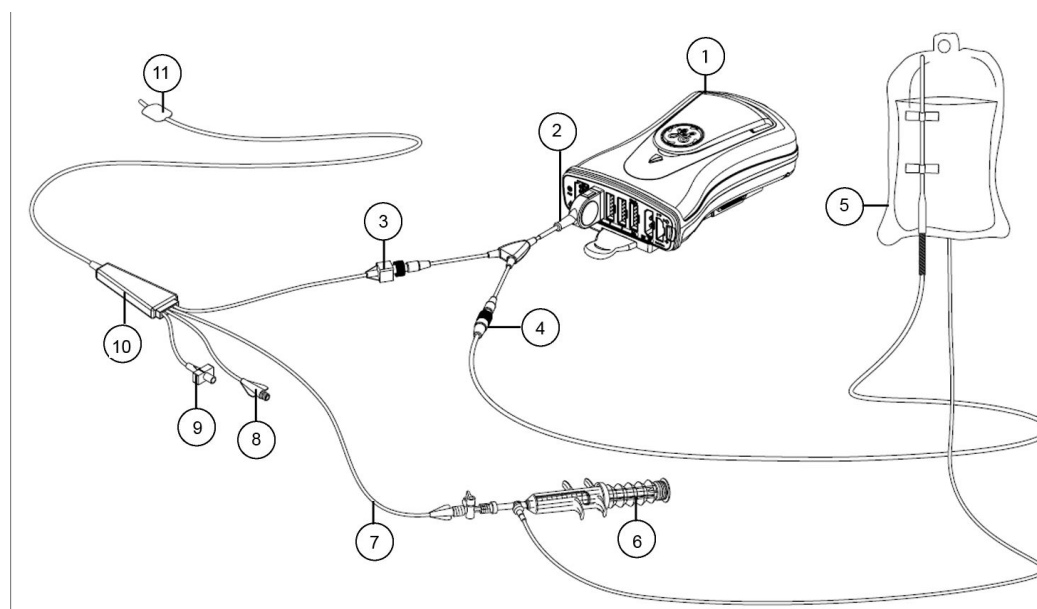

1. Module with C.O. measurement capability
2. Cardiac output cable
3. Thermistor connector
4. Injectate temperature bath probe
5. Injectate fluid
6. Injectate syringe
7. Proximal injectate port
8. PA distal port
9. Balloon inflation valve
10. Swan-Ganz thermodilution catheter
11. Balloon

C.O. module key

There is one C.O. module key on the E-COP and E-COPsv modules:

Start C.O.	Starts and stops the cardiac output measurement.
-------------------	--

Preparing the C.O. measurement

1. Connect the C.O. cable to the acquisition module, thermistor, and injectate temperature port.
2. Follow your care unit's policy and procedures for positioning the patient for the C.O. measurement.

3. Follow the catheter manufacturer's instructions to set up the in-line or bath probe patient cables.
4. For an in-line setup, make sure the in-line sensor is securely connected to the tubing.
5. For the bath probe setup, make sure the bath probe is correctly sensing the injectate temperature.

Checking the C.O. measurement

1. Check that the monitor recognizes cable connections (activates the display) and all C.O. menu selections are available.
2. Remember that in order to get Cardiac Index (C.I.) you must first enter the patient demographics.
3. For E-modules, check that the message **Press Start C.O.** appears on the screen.

Using the C.O. measurement

Entering patient data for the C.I. value

The patient's height and weight values are required for determining cardiac index (C.I.).

1. Select the cardiac output parameter window.
2. Select **Demographics** from the **Measurement** tab.
3. Set the patient's height and weight.

The BSA value is calculated automatically once the height and weight have been selected.

4. You can return to the **Cardiac Output** menu by selecting **Previous Menu**.

C.O. measurement modes

C.O. measurements can be taken using the automatic or manual measurement modes. Both measurement modes allow you to use up to six C.O. measurements for calculating a C.O. average.

You can confirm the C.O. measurements within 15 minutes from the start of the first thermodilution measurement, so even if you leave the menu the measurements will not disappear during this time.

Taking an automatic C.O. measurement

PDM and TRAM: When measuring C.O. using the automatic mode, the monitor averages approximately 8.5 seconds of the patient's blood temperature before establishing a stable baseline and displaying the **Inject When Ready** message.

E-modules: When measuring C.O. using the automatic mode, new measurements can be taken when the **Press Start C.O. Serial** message displays.

Holding the injectate syringe by the plunger, not the barrel, improves measurement accuracy.

1. Select the cardiac output parameter window.
2. Select the **Setup** tab.

3. Select the radio button for **Automatic** measurement type.
4. Verify that the catheter settings are correct.
5. Select the **Measurement** tab.
6. Complete the following:
 - a. PDM and TRAM: Get ready to inject the injectate solution when the message **Inject When Ready** appears.
 - b. E-modules: When the message **Press Start C.O. Serial** appears, select **Start C.O. Serial**.
7. Inject the injectate solution smoothly within 4 to 5 seconds.
8. The message **Measuring** displays, followed by the message **Please wait** until the calculation is completed.
9. Observe the washout curve displayed on the screen. The message **C.O. Complete** displays after the C.O. determination has been made, followed shortly by the message **Please wait**.
The curve disappears from the screen when the next measurement cycle can start.
10. To take another C.O. measurement, wait for this message to display before injecting the injectate:
 - PDM and TRAM: **Inject When Ready**
 - E-modules: **Inject now!**

Taking a manual C.O. measurement

Measuring C.O. using the manual mode allows you to determine when to begin the injection procedure. This mode may be preferred for patients with extreme blood temperature fluctuations, or when the automatic mode is unable to establish a stable baseline.

Holding the injectate syringe by the plunger, not the barrel, improves measurement accuracy.

1. Select the cardiac output parameter window.
2. Select the **Setup** tab.
3. Select the radio button for **Manual** measurement type.
4. Select the **Measurement** tab and verify that the catheter settings are correct.
5. Select **Start C.O.**
With E-modules, you can also use the **Start C.O.** module key.
6. When the **Inject now!** message appears, inject the injectate solution smoothly within 4 to 5 seconds.
7. The message **Measuring** displays, followed by the message **Please wait** until the calculation is completed.
8. Observe the washout curve displayed on the screen. The message **C.O. Complete** displays after the C.O. determination has been made, followed shortly by the message **Please wait**.

The curve remains on the screen.

9. Allow 1 to 1.5 minutes between injections to stabilize the catheter baseline temperature.
10. To perform another C.O. measurement, wait for the **Press Start C.O.** message to display, then select **Start C.O.**

C.O. trial measurements

A real-time washout curve and numeric value are displayed with each cardiac output trial. Up to six measurements are retained. The program automatically averages each C.O. injection. When saved, the averaged value is entered into the hemodynamic calculations. The last saved average C.O. value is displayed in the parameter window with a timestamp.

Printing a report of C.O. trials

The C.O. report must be initiated before confirming the C.O. measurements.

1. Select the cardiac output parameter window.
2. Select the **Measurement** tab.
3. Select **Print**.

The selection is available only if you have not confirmed the C.O. measurements.

Editing the C.O. average

1. Select the cardiac output parameter window.
2. Select the **Measurement** tab.
3. Select **Edit Average**.
4. Check the selection boxes for those trials you wish to include in the C.O. average. If you do not wish to include a trial, ensure its selection box is not checked.
5. Select **Confirm C.O.** to store the calculated C.O. average and display it in the cardiac output parameter window.

If you wish to print a C.O. report, you must start printing before confirming the C.O.

Canceling a C.O. measurement

When a C.O. measurement has just completed, you can remove this C.O. measurement trial without entering the **Edit Average** window.

1. In the **Measurement** tab, select **Cancel/Reject Injection**.

E-modules: In addition to removing the previous measurement, you can also cancel an in-process measurement.

C.O. catheter selections

You can select a cardiac output catheter from a list of default catheters and preconfigured catheters, or enter a catheter for temporary use. Pre-configured catheters which show up in the list can be added or deleted through **Care Unit Settings > Parameters > Catheters**. These settings are password protected.

For more information, see the supplemental information manual.

Selecting a C.O. catheter from the list

1. Select the cardiac output parameter window.
2. Select the **Setup** tab.
3. Select a catheter name from the **Manufacturer** list.
4. Select a catheter model from the **Model** list.

Entering a user-defined C.O. catheter

All user-defined catheter settings are erased when the monitor is discharged.

1. Select the cardiac output parameter window.
2. Select the **Setup** tab.
3. Select **User Defined** from the **Manufacturer** list.
4. Set the **Injectate Volume** to match the value listed on the catheter packaging.
5. Set the **Computation Constant** to match the value listed on the catheter packaging:
 - **Ice Cold**: temperature below +6°C.
 - **Room Temp**: temperate above +18°C.
 - Any other injectate temperature value between +6°C and +18°C.

Selecting the C.O. injectate probe type

NOTE PDM and TRAM only. E-modules detect the type of injectate probe automatically.

1. Select the cardiac output parameter window.
2. Select the **Setup** tab.
3. Select the correct **Probe Type**: **Bath** or **In-Line**.

Setting a C.O. right ventricular ejection fraction (REF) measurement

NOTE E-COP and E-COPsv modules and catheters that support right ventricular ejection fraction measurement only. PDM and TRAM do not provide a REF measurement.

A valid heart rate is required to take a REF measurement. ECG from a telemetry transmitter cannot be used.

1. Select the cardiac output parameter window.
2. Select the **Setup** tab.
3. Select the check box for **REF Measurement**.

Selecting the C.O. scale

This selection sets the upper limit of the waveform scale for the thermodilution waveform fields.

1. Select the cardiac output parameter window.

2. Select the **Setup** tab.
3. Select a value from the **Scale** list.

Selecting what to show with C.O.

This setting affects the contents of the cardiac output parameter window.

1. Select the cardiac output parameter window.
2. Select the **Setup** tab.
3. Select a value from the **Show with C.O./C.I.** list: **None**, **PCWP**, **Tblood**. With E-COP and E-COPsv you can also select **REF**.

If you have an interfaced device measuring CCO, the list is called **Show with CCO/CCI**.

Setting the Tblood alarm

1. Select the cardiac output parameter window.
2. Select the **Setup** tab.
3. Select **Tblood Alarm**.
4. Set the Tblood alarm limits as required.
5. You can return to the cardiac output menu by selecting **Previous Menu**.

Adjusting the SvO₂ from the cardiac output menu

NOTE E-modules and catheters supporting the SvO₂ measurement only.

1. Select the cardiac output parameter window.
2. Select the **Setup** tab.
3. Select **SvO2**.
4. Adjust the SvO₂ settings as required.
5. You can return to the cardiac output menu by selecting **Previous Menu**.

Editing calculations

When a C.O. measurement has been confirmed, you can access the calculations menu and adjust the hemodynamic, oxygenation, or ventilation calculation values as needed.

1. Select the cardiac output parameter window.
2. Select the **Measurement** tab.
3. Select **Calculations**.
4. Make necessary changes by selecting the **Hemo**, **Oxy**, or **Vent** tab and then **Edit Input**.
5. You can return to the **Cardiac Output** menu by selecting **C.O.** or **Previous Menu**.

Adjusting the wedge from the cardiac output menu

The **Wedge** selection is available only when there is a confirmed C.O. measurement and an invasive pressure channel has been labeled as **PA**.

1. Select the cardiac output parameter window.
2. Select the **Measurement** tab.
3. Select **Wedge**.
4. Adjust the wedge settings as required.
5. You can return to the cardiac output menu by selecting **Previous Menu**.

Stopping the cardiac output measurement

1. Remove the catheter from the patient.
2. Disconnect the probe patient cables.

C.O. practicalities

Cardiac output washout curve

The washout curve, which displays after a C.O. injection, shows the drop in blood temperature as the injectate mixes with the blood. The peak of the curve indicates the maximum difference in the patient's baseline blood temperature and the temperature of the injectate solution. As the mixture passes through the catheter and then out the pulmonary artery, the temperature difference decreases as indicated by the curve returning to the baseline. A spike is displayed at the onset of the curve, again at 70% of the maximum temperature difference, and again at 35% of the maximum temperature difference. Spikes are also visible during an ongoing C.O. measurement.

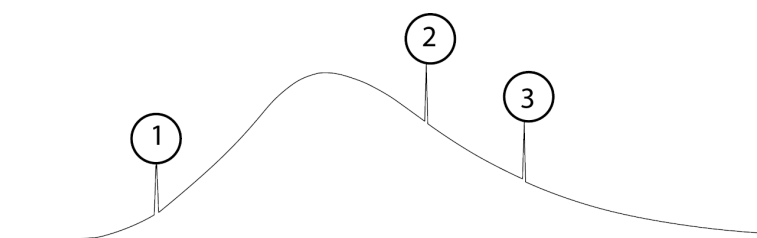

1. Onset spike
2. 70% spike
3. 35% spike

Cardiac output is inversely proportional to the area under the thermodilution curve. Cardiac output varies with body size. To more accurately assess cardiac performance for individual patients, the cardiac index is often used.

How to improve the C.O. accuracy

The following influencing factors can influence the cardiac output accuracy:

- The technique used in performing a cardiac output.
- Temperature of the injectate solution.
- Volume of the injectate solution.

Cardiac output

- Patient's baseline blood temperature.
- Patient's inspiratory/expiratory cycle.
- Placement of catheter with relation to proximity of lung field.
- The pulmonary artery catheter itself.
- The patient's rhythm and hemodynamic status.
- Any other rapid IV solutions which are infused while the cardiac output is being performed.

The following are suggestions about technique that can help obtain accurate cardiac output:

- Always hold the syringe by the plunger, not the barrel.
- Inject solution rapidly and smoothly.
- Inject within four to five seconds.
- Inject at end expiration.
- When not using an automatic program, wait one minute between injections to allow baseline to stabilize.
- The temperature of the injectate should always be colder than blood temperature. Keep the handling and waiting time with a filled syringe before injection as short as possible. Warm injectate may lead to erroneous C.O. values.
- The probe can be a bath probe continuously measuring the cooling bath temperature or the infusion bag temperature. Alternatively, a flow-through probe is used for a closed injectate delivery. With an in-line system, the displayed injectate temperature is the lowest temperature measured during injection.

C.O. troubleshooting

Problem	Solution
C.O. measurement fails?	The amount of injectate is too small or the injectate is too warm. <ul style="list-style-type: none">• Inject smoothly and within 4 to 5 seconds.
What if the C.O. value is lower than expected?	Cardiac output must be computed within 20 seconds. Decreasing the volume and increasing the temperature will give you a smaller differential change and should increase the chance of computing a cardiac output within the 20-second period. <ul style="list-style-type: none">• Decrease the volume injected.• Increase the temperature of the injectate.
What if the C.O. value is higher than expected?	Cardiac output must be computed within 20 seconds. Increasing the volume and decreasing the temperature will give you a greater differential change. <ul style="list-style-type: none">• Increase the volume injected.• Decrease the temperature of the injectate.

Problem	Solution
What if a stable baseline temperature cannot be detected?	<p>A message indicating a failure is displayed.</p> <ul style="list-style-type: none"> • Check the patient and the C.O. setup (both the settings and the cables). • Check for a significant amount of respiratory variation and for rapid IV solution infusion, either of which may influence the baseline temperature. It may be necessary to stop or slow the solution infusion during C.O. measurement, however, use caution if the solution includes drugs/medication. • Check the injectate temperature (IT). There should be a minimum temperature difference of 10° C (18° F) between the patient blood temperature and the injectate solution temperature. Cool the injectate solution if needed to increase the difference. • Replace the injectate temperature cable. • The pulmonary artery catheter may be damaged. Replace it.
What if the cardiac output values are inaccurate?	<p>When in-line is being used along with iced injectate, the initial temperature displayed will be the room temperature. However, when the solution is injected, the temperature displayed will decrease.</p> <ul style="list-style-type: none"> • Technique. It is important to understand the technique used in performing a cardiac output since it is a major influencing factor in obtaining accurate cardiac output values. <ul style="list-style-type: none"> ▪ If room temperature solution is used, be sure the bag is not exposed to a supplemental heat source or touching other solutions or equipment. This is important so the solution temperature will be the same as the room air temperature sensed through the bath or in-line probe. Any difference in temperature could give an inaccurate reading. ▪ When injecting, always hold the syringe by the plunger and not by the barrel. The temperature of the solution increases at a slower rate if the barrel is not held, and therefore reduces the potential for error in a cardiac output value. ▪ It is recommended that you inject rapidly and smoothly into the proximal port of the pulmonary artery catheter, within 4 to 5 seconds. ▪ Allow the baseline to stabilize between injections. If automatic program is not being used, allow one minute between injections. If automatic program is being used, follow the monitor prompts to inject. ▪ It is also recommended that you inject at the patient's end expiration. This helps reduce any respiratory noise and therefore lessens error.

Problem	Solution
	<ul style="list-style-type: none"> ■ A minimum difference of 10° C (18° F) between the patient blood temperature and solution/injectate temperature is recommended. ● Respiration. The patient's inspiratory/expiratory cycle and placement of the catheter affects the cardiac output value. Whenever the patient inhales and exhales, the temperature in the lung changes. During inspiration, the patient's blood temperature decreases and during expiration it increases. Therefore, placement of the catheter in relation to proximity of the lung fields affects the baseline. If there is a significant amount of respiratory noise on the patient's baseline, cardiac output may be calculated even if no injection was performed. There is no differentiation between temperature change caused by breaths versus injections. It simply looks for a change in baseline temperature. ● Baseline blood temperature. As little as a half a degree Celsius change in blood temperature due to respiratory noise may cause a C.O. value to be displayed when an injection has not been performed. Using auto mode looks for a stable baseline before allowing an injection. ● Pulmonary artery catheter. The catheter itself may be damaged (e.g., defective thermistor or defective tubing). ● Hemodynamics. The patient's rhythm can affect the cardiac output value. If cardiac output trials are being done at a time when the patient has arrhythmias, you may notice a discrepancy in the cardiac output values. ● Rapid IV solutions. Any rapid IV solution that is infusing at the time when the solution is injected can alter the cardiac output value. Maintain a constant rate, or if possible, stop the solution 30 seconds before the C.O. injection and then restart the infusion after the cardiac output is calculated. ● Injectate temperature fluctuation. If the injectate temperature is fluctuating, check the injectate temperature cable connection.
<p>What if cardiac output is being calculated even though solution has not been injected?.</p>	<p>There may be a change in the patient's blood temperature consistent with an injection.</p> <ul style="list-style-type: none"> ● Check the patient and the C.O. setup (both the settings and the cables). ● Check for a significant amount of respiratory variation and for rapid IV solution infusion, either of which may influence the baseline temperature. It may be necessary to use the manual cardiac mode rather than the automatic mode.

15

Mixed venous oxygen saturation (SvO₂)

SvO₂ compatibility limitations

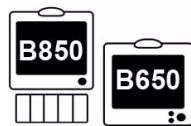

All features of this measurement are available for both monitors.

For detailed information regarding module, monitor, and accessory compatibility, see the supplemental information manual.

SvO₂ safety precautions

SvO₂ warnings

WARNING

All invasive procedures involve risks to the patient. Use aseptic technique. Incorrect use of the catheter can lead to vessel perforation. Follow catheter manufacturer's instructions.

WARNING

When using an electrosurgery unit, note that the measurement cables do not incorporate means to protect against burns in case of a defective ESU return electrode. To avoid burns at the monitor measurement sites, ensure the following:

- Proper contact of the ESU return electrode to the patient.
- ESU return electrode near the operating area.
- Measurement electrodes, leadwires and probes far from the surgical site and the ESU return electrode.

WARNING

The use of such dyes that usually change the patient blood pigmentation may lead to faulty oxygen saturation measurement values.

SvO₂ measurement limitations

The SvO₂ measurement is not intended for neonatal patients.

SvO₂ points to note

- Follow the catheter manufacturer's instructions for inserting the catheter.
- For reliable saturation values, the signal strength indicator should be higher than one asterisk.
- Depending on the SvO₂ module used, not all SvO₂ measurements and settings are available to view or change.

SvO₂ measurement setup

SvO₂ equipment to patient connection

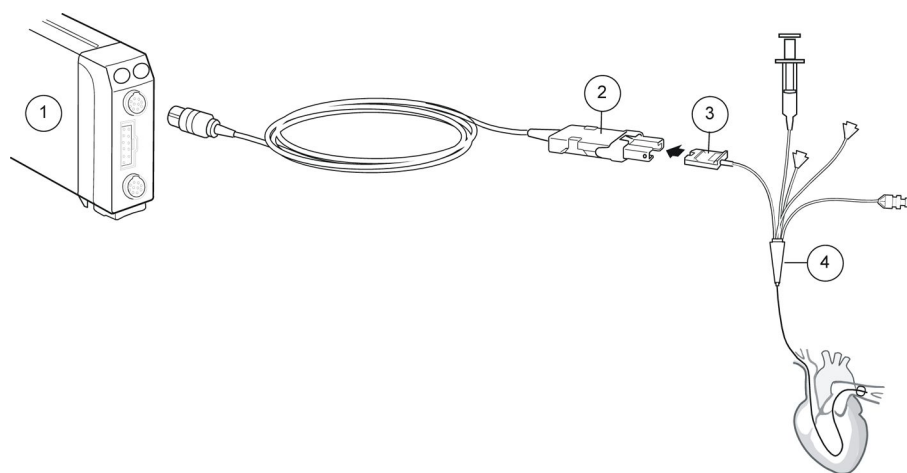

1. Module with SvO₂ measurement capability, E-COPsv
2. Optical module
3. Optical connector
4. Swan-Ganz thermodilution catheter

Checking the SvO₂ measurement

1. Check that the SvO₂ value is displayed when the catheter is inserted, the measurement has been started and the **Warming up** message has disappeared.
2. Check the position of the catheter regularly.
3. Calibrate in vivo and update the Hb value at least every 24 hours.

SvO₂ measurement on screen

Signal quality indicator from the catheter (only present when the SvO₂ is measured from an external device):

Indicator	Explanation
no asterisk	No signal
*	Poor signal
**	Fair signal
***	Good signal

Using the SvO₂ measurement

SvO₂ calibration in vitro

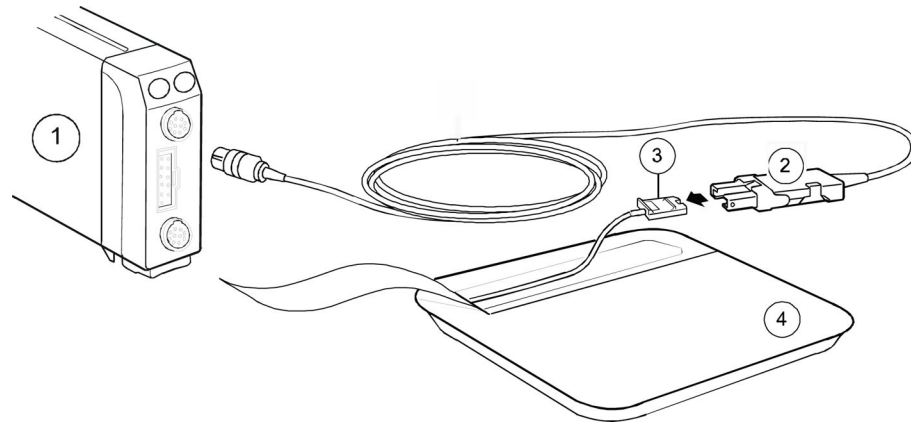

1. Module E-COPsv
2. Optical module
3. Optical connector
4. Swan-Ganz thermodilution catheter

Calibrating a new SvO₂ catheter in vitro

NOTE

Do not perform in vitro calibration if the catheter has been flushed. Using a wet catheter and calibration cup results in an inaccurate calibration.

Always perform in vitro calibration with a new catheter before removing it from its package. Follow the **Advice to User** information displayed in the **Calibration** window to guide you through the calibration steps.

1. Connect the optical module to the module and let it warm up for 20 minutes.
2. Aseptically expose the catheter's optical connector.
3. Connect the catheter to the optical module.
4. Select the SvO₂ parameter window.
5. Select the **Calibration** tab.
6. If replacing an existing catheter, select **New Catheter**.
7. Select **In Vitro Calibration** > **Calibrate** to perform in vitro calibration.
8. Select **Start SvO₂** to complete the in vitro calibration.
9. Insert the catheter into the patient.

Recalling a previous in vitro calibration

After completing a successful initial calibration, you can recall the previous in vitro calibration measurement when:

- The optical module is connected and has not been calibrated since being connected.

- An in vitro calibration was completed with this optical module using the same catheter within the last 24 hours.
1. Select the SvO₂ parameter window.
 2. Select the **Calibration** tab.
 3. Select **Recall Calibration**.

Calibrating SvO₂ in vivo

NOTE For optimal accuracy, perform in vivo calibration at least every 24 hours.

Follow the **Advice to User** information displayed in the **Calibration** window to guide you through the calibration steps.

1. Select the SvO₂ parameter window.
2. Select the **Calibration** tab.
3. Select **In Vivo Calibration** > **Calibrate** to perform in vivo calibration using the SvO₂ and Hb values measured from the blood sample.
4. Select **Draw Blood Sample** and slowly draw a blood sample.
5. Enter the laboratory results:
 - a. Select a value for **Lab SvO₂**.
 - b. Select a value for **Lab Hb**.
6. Select **Save Lab Values** to complete calibration.

Updating the Hb value for SvO₂ measurement

The patient's Hb value should be updated at least every 24 hours as it affects the SvO₂ measurement. The **Update Hb** selection is active after in vivo calibration has been completed with the **Save Lab Values**.

1. Select the SvO₂ parameter window.
2. Select the **Calibration** tab.
3. Select **Update Hb** and set the value.

Setting the SvO₂ alarms

1. Select the SvO₂ parameter window.
2. Select the **Alarms** tab.

If alarms have been set to **Alarm Off**, the alarm limits are greyed out. Select **Alarm On** to set the alarms.
3. Set the alarm limits.

Stopping the SvO₂ measurement

1. Remove the catheter from the patient.
2. Disconnect the catheter from the optical module.
3. Disconnect the optical sensor from the SvO₂ module.
4. Discard the catheter.

SvO₂ measurement description

The SvO₂ value is measured continuously by spectrophotometry. The algorithm consists of five different parts:

- Initialization: When connected, a number of start-up procedures are performed prior to normal operation. These procedures include transfer of calibration factors and initialization of LED currents.
- Calibration
- Signal processing and SvO₂ calculation: Light of various wavelengths (red 660 nm and infrared 810 nm) is transmitted to the blood through a single plastic optical fiber in the oximetry catheter, and reflected back through a separate optical fiber to a photodetector. The light is electrically transmitted and analyzed. From the amount of reflected light it is possible to measure the amount of light absorbed by hemoglobin and oxyhemoglobin, resulting in the SvO₂ value. The SvO₂ value is displayed as a percentage.
- Automatic gain control: The intensity of the red and infrared signals can be amplified by four different gains. The gain is selected automatically to achieve optimal signal levels.
- Signal quality

SvO₂ troubleshooting

Problem	Solution
SvO ₂ levels are too high	<ul style="list-style-type: none"> • Position the catheter correctly. • Calibrate in vivo.
In vivo calibration fails	<ul style="list-style-type: none"> • Check the connections. • Check that the optical cables have no sharp bends. • If the in vivo calibration fails again, replace the catheter and/or the optical module, and repeat the procedure.

Mixed venous oxygen saturation (SvO₂)

16

Airway gases

Airway gases compatibility limitations

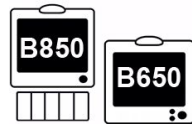

All features of this measurement are available for both monitors.

For detailed information regarding module, monitor, and accessory compatibility, see the supplemental information manual.

Airway gases safety precautions

Airway gases warnings

- WARNING** Always inspect the airway adapter for a tight connection and proper operation before attaching it to the patient.
- WARNING** Leaks in the gas sampling circuit (water trap and sampling line) may cause inaccurate readings.
- WARNING** Remove the airway sampling line from the patient's airway while nebulized medications are being delivered.
- WARNING** Handle the water trap and its contents as you would any body fluid. Infectious hazard may be present.
- WARNING** Since sample gas may contain anesthetic agents, make sure that it is not released in the room. Connect exhaust to a scavenging system to prevent exposure to anesthetic agents.
- WARNING** Strong scavenging suction may cause excessive sample gas flow and inaccurate gas readings.
- WARNING** Route all tubing away from the patient's throat to avoid strangulation.
- WARNING** To avoid the spread of infectious disease, do not allow the exhaust to discharge in the direction of the patient or user.
- WARNING** EtCO₂ values may differ from blood gas readings.

- WARNING** Do not use a CO₂ module at the same time as a compact airway module or a CARESCAPE respiratory module.
- WARNING** When using the CARESCAPE respiratory modules with volume controlled ventilation at low tidal volumes, the specified gas withdrawal rate may significantly reduce the amount of gas delivered to the patient.
- WARNING** CARESCAPE respiratory modules: Make sure to compensate for the possible reduction of tidal volume caused by the 120 ml/min gas sample flow.
- WARNING** Compact airway modules: Do not use these modules on patients that cannot tolerate the removal of 200 ml/min from their total minute ventilation.
- WARNING** E-miniC modules: Do not use this module on patients that cannot tolerate the removal of 150 ml/min from their total minute ventilation.
- WARNING** A failure in zeroing or calibrating airway gases may cause inaccurate readings.
- WARNING** Ensure that the compact airway modules and CARESCAPE respiratory modules are in vertical position when used. Tilting them may result in erroneous readings.
- WARNING** Since calibration gas contains anesthetic agents, always ensure sufficient ventilation of the room during calibration.
- WARNING** Do not wash, disinfect or open the water trap cartridge. Do not touch the water trap membrane. The hydrophobic membrane is damaged if any cleaning is attempted, and this may result in the contamination of the gas sensors.
- WARNING** Compact airway modules: Never connect any tubing to the reference gas inlet connector. The inlet must be open at all times.
- WARNING** E-miniC: O₂, N₂O and anesthetic agent gases may interfere with EtCO₂ readings.
- WARNING** To avoid the risk of patient cross-infection, do not return the sampled gas to the breathing system.

WARNING Always ensure the correct size and fit of accessories according to patient type and application, especially when monitoring pediatric and neonatal patients. The size and fit of accessories may impact the measured gas concentration values at low tidal volumes. It is recommended to have the gas sampling port close to the proximal end of the endotracheal tube. Excessive dead space in the circuit, including the accessories, may cause re-breathing of gases. Very low accessory dead space between the breathing circuit Y-piece and the gas sampling site may impact the measured gas concentration due to dilution of the sampled exhaled gas with fresh gas from the ventilator. To confirm accurate correlation with measured gases and blood, check arterial blood gas values to confirm a suitable setup is used.

Airway gases cautions

CAUTION Never connect the loose end of the gas sampling line to the Patient Spirometry connector as this may break the spirometry unit. The Patient Spirometry connector is meant for the Patient Spirometry tube only.

CAUTION Do not apply pressurized air or gas to any outlet or tubing connected to the monitor. Pressure may destroy sensitive elements.

Airway gases measurement limitations

- E-modules can be used within their specified performance range with OR, PACU, ICU, and ED software packages.
- E-miniC is not suitable for use with patients weighing less than 5 kg (11 lbs).

Airway gases points to note

- If anesthetic agents are present, use GE Healthcare anesthesia sampling lines (PE/PVC). Otherwise, you can use GE Healthcare CO₂ sampling line (PVC).
- Compact airway modules and CARESCAPE respiratory modules: Anesthetic agent identification, MAC or MACage, N₂O and EtBal are available with the anesthetic agent measurement license only. This license is available for OR, PACU, and ICU software packages.
For more information, see the supplemental information manual.
- Make sure that you are using a water trap that is compatible with the module:
 - CARESCAPE respiratory modules: D-fend Pro or D-fend Pro+
 - Compact airway modules: D-fend or D-fend+
 - E-miniC: Mini D-fend
- Empty the water trap container as soon as it is more than half full.
- Place the airway adapter between the HME and Y-piece.
- Place the airway adapter with all sampling ports upwards.
- Always check the tightness of all connections.
- Make sure that the gas sampling line is properly connected to the water trap and the water trap is properly connected to the airway gas module. Gas leaks in these

connections may dilute the gas sample from the patient circuit, thus resulting in erroneous gas readings. During normal operation, all sampled gas flows out of the sample gas outlet. Room air is used as reference gas for the oxygen measurement and it is mixed with the sampled gas. The sampled gas is diluted by room air so that the fraction of room air in the exhaust gas is about 20%.

- Compact airway modules: The message **Sample line blocked** may result if you attach the sampling line to the water trap after the monitor has completed the self-check for the module. Attach the sampling lines to the water trap before turning on the monitor.

Airway gases measurement setup

Airway gases equipment to patient connections with CARESCAPE respiratory modules

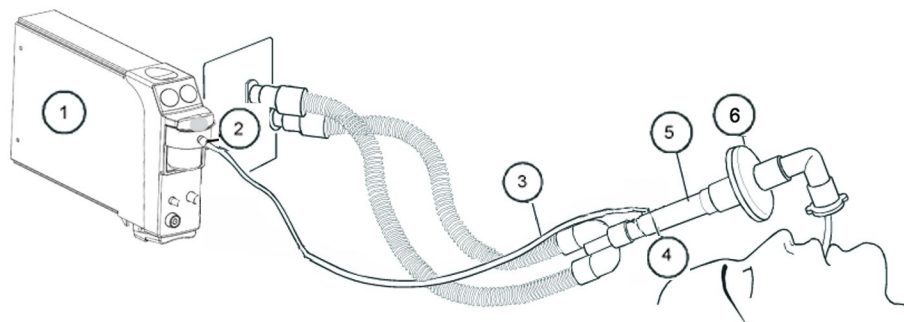

1. CARESCAPE respiratory module
2. Gas sample, gas sampling line connector on the water trap
3. Gas sampling line
4. Gas sampling line connector on the airway adapter; place the connector upwards
5. Airway adapter with sampling line connector
6. Heat and moisture exchanger with filter (HMEF) (optional)

Airway gases equipment to patient connections with compact airway modules, anesthesia setup

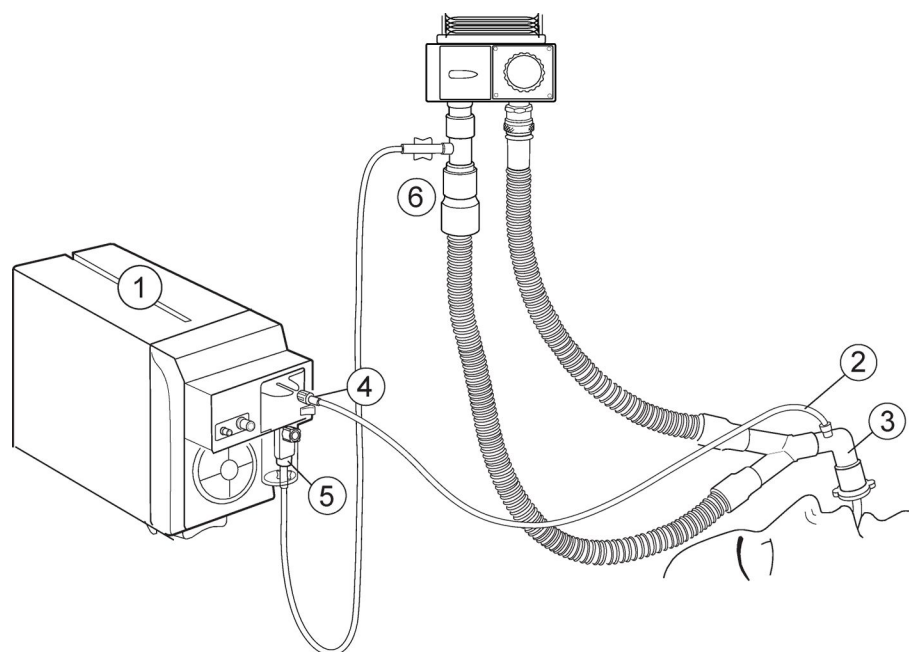

1. Compact airway module.
2. Anesthesia gas sampling line
3. Airway adapter with sampling line connector
4. Sampling line connector on the water trap
5. Sample gas outlet (gas exhaust)
6. Returning sample gas to patient circuit

Airway gases equipment to patient connections with compact airway modules, critical care setup

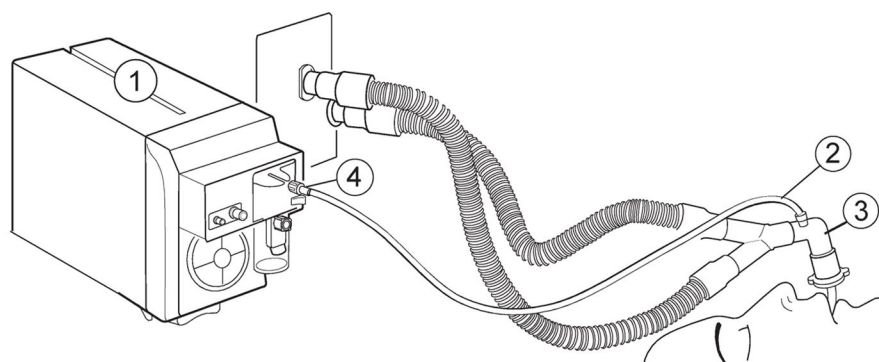

1. Compact airway module
2. Gas sampling line

3. Adapter with sampling line connector
4. Sampling line connector on the water trap

Airway gases equipment to patient connections with E-miniC, critical care setup

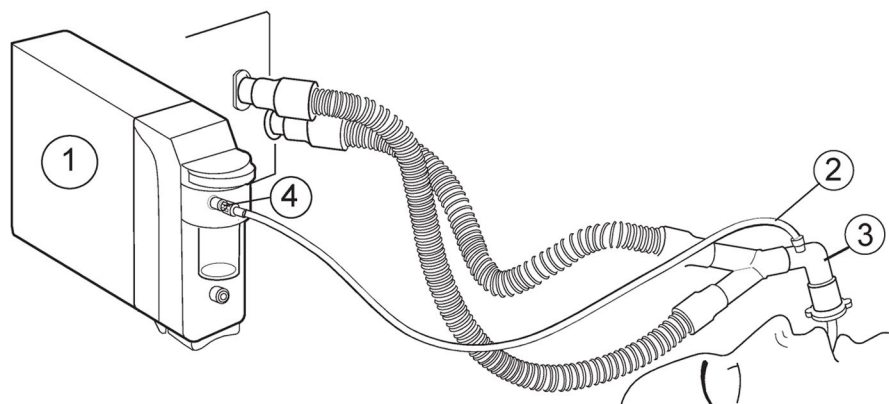

1. E-miniC module
2. Gas sampling line
3. Adapter with sampling line connector
4. Sampling line connector on the water trap

Airway gases measurement setup

1. Make sure that the water trap container is empty and properly attached.
2. Connect the gas sampling line to the sampling line connector on the water trap.
3. Connect the sample gas outlet to gas scavenging if N₂O or volatile agents are used.
4. Turn on the monitor or connect the module to the monitor. The monitor performs a self-check for the module when the module is connected. Automatic agent identification is activated in those modules that have this feature.
5. Wait until the message **Calibrating** disappears.
6. Connect the sampling line to the airway adapter or the airway adapter to the ventilator circuit. Position the adapter with the sampling port upwards to minimize the amount of condensed water possibly entering the sampling line.
7. Check that the airway adapter connections are tight and that the adapter is operating properly.

NOTE Check that the sample line is connected to the water trap before connecting the module to the monitor or turning on the monitor.

NOTE To minimize the amount of dust drawn into the gas sampling system, always keep the water trap connected to the module. When gas measurement is not in use, you can disconnect the module from the monitor to eliminate the operating sound of the gas pump.

CARESCAPE respiratory module connectors

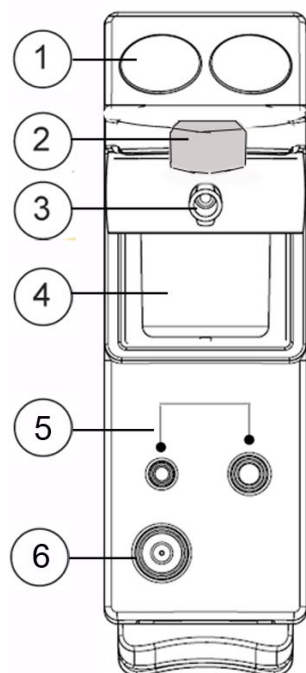

1. Patient Spirometry keys
2. Water trap release/locking latch
3. Gas sample, sampling line connector on the water trap
4. Water trap container
5. Connectors for Patient Spirometry tubes
6. Gas exhaust, connector for the gas exhaust line

Compact airway module connectors

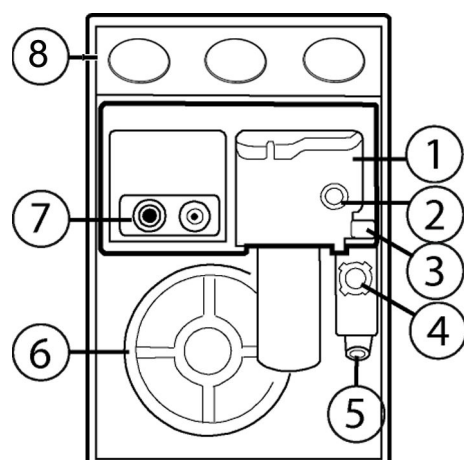

1. D-fend water trap with washable container
2. Sampling line connector on the water trap
3. Water trap latch

4. Oxygen reference gas inlet
5. Sample gas outlet (gas exhaust)
6. Cooling fan with dust filter
7. Patient Spirometry connectors
8. Patient Spirometry keys

E-miniC module connectors

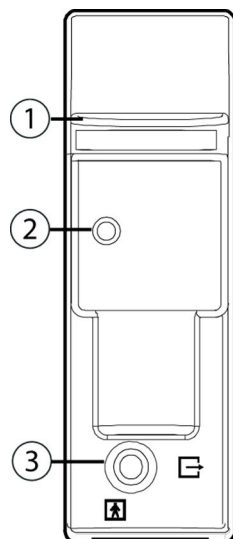

1. Water trap latch
2. Sampling line connector on the water trap
3. Sample gas outlet (gas exhaust)

E-miniC indications for use

E-miniC and accessories are indicated for monitoring CO₂ and respiration rate of all hospital patients. E-miniC is indicated for monitoring patients weighing more than 5 kg (11 lbs). The device is indicated for use by qualified medical personnel only.

Airway gases alternative patient connections

- With E-sCAiO, E-sCO, E-CAiO, E-CO and E-miniC, use an airway adapter and a sampling line.
- With E-sCAiOV, E-sCOV, E-CAiOV, E-CAiOVX, E-COV, and E-COVX modules, use the D-lite(+)/Pedi-lite(+) sensor and a gas sampling line with Patient Spirometry tubing. When monitoring pediatric patients, remember to select the sensor type accordingly from the monitor menu.

Tracheostomy

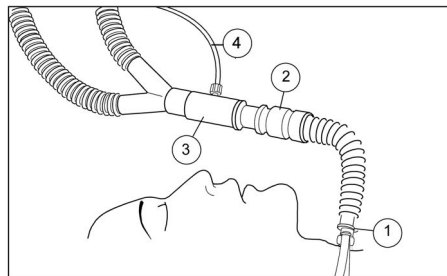

1. Tracheostomy tube with 15 mm connector
2. Heat and Moisture Exchanger (HME)
3. Airway adapter
4. Sample line

Mask ventilation

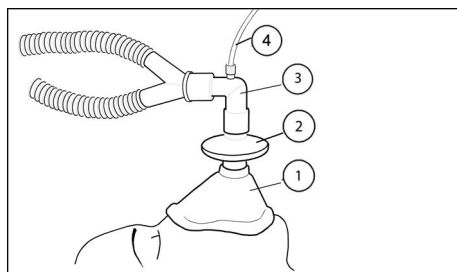

1. Mask
2. Bacterial filter
3. Airway adapter
4. Sample line

Infant ventilation

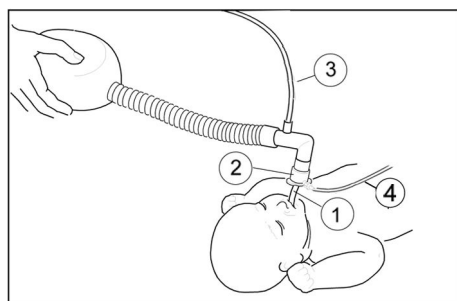

1. Endotracheal tube
2. Pediatric airway adapter
3. Fresh gas inlet
4. Sample line

Checking the airway gases measurement

1. Check that the water trap container is empty.

2. Occlude the sampling line and check that the **Sample line blocked** message appears within 30 seconds and gas waveforms are showing zero at the same time.

Airway gases parameters

Airway gases parameters, CARESCAPE respiratory modules

The CARESCAPE respiratory modules measure the following airway gas parameters:

Parameter	E-sCAiO	E-sCAiOV	E-sCO	E-sCOV
CO ₂	x	x	x	x
O ₂	x	x	x	x
N ₂ O	x	x	x ¹	x ¹
AA	x	x	n/a	n/a
Agent ID	x	x	n/a	n/a
Additional measurements				
MAC	x	x	n/a	n/a
MACage	x	x	n/a	n/a
Balance gas	x	x	n/a	n/a
Gas exchange	n/a	n/a	n/a	n/a
Patient Spirometry	n/a	x	n/a	x
Respiration rate	x	x	x	x
Sampling method				
Sidestream	x	x	x	x
Mainstream	n/a	n/a	n/a	n/a
¹ automatic compensation.				
NOTE The measured N ₂ O value is not displayed.				

Airway gases parameters, compact airway modules

Parameter	E-CAiO	E-CAiOV	E-CAiOVX	E-CO	E-COV	E-COVX
CO ₂	x	x	x	x	x	x
O ₂	x	x	x	x	x	x
N ₂ O	x	x	x	x ¹	x ¹	x ¹
AA	x	x	x	n/a	n/a	n/a
Agent ID	x	x	x	n/a	n/a	n/a
Additional measurements						
MAC	x	x	x	n/a	n/a	n/a
MACage	x	x	x	n/a	n/a	n/a
Balance gas	x	x	x	n/a	n/a	n/a
Gas exchange	n/a	n/a	x	n/a	n/a	x

Parameter	E-CAiO	E-CAiOV	E-CAiOVX	E-CO	E-COV	E-COVX
Patient Spirometry	n/a	x	x	n/a	x	x
Respiration rate	x	x	x	x	x	x
Sampling method						
Sidestream	x	x	x	x	x	x
Mainstream	n/a	n/a	n/a	n/a	n/a	n/a
¹ automatic compensation.						
NOTE The measured N ₂ O value is not displayed.						

Airway gases parameters, E-miniC

Parameter	E-miniC
CO ₂	x
O ₂	n/a
N ₂ O	x ¹
AA	n/a
Agent ID	n/a
Additional measurements	
MAC	n/a
MACage	n/a
Balance gas	n/a
Gas exchange	n/a
Patient Spirometry	n/a
Respiration rate	x
Sampling method	
Sidestream	x
Mainstream	n/a
¹ automatic compensation.	
NOTE The measured N ₂ O value is not displayed. E-miniC requires manual selection from the monitor menu to compensate for N ₂ O.	

Using the E-modules for CO₂ measurement

Available menu selections

NOTE Available menu selections may differ according to the modules and/or software packages. Please read the following instructions carefully. If nothing is mentioned about the availability of the selection, it is the same for all modules and/or software packages.

Selecting the CO₂ scale

If EtCO₂ is above 6% (45 mmHg), change the scale for capnogram.

1. Select a gas related parameter window.
2. Select the **CO₂** tab > **Setup**.
3. Select an option from the **Scale** list.

Selecting the CO₂ sweep speed

This selection affects the waveform.

1. Select a gas related parameter window.
2. Select the **CO₂** tab > **Setup**.
3. Select an option from the **CO₂ Sweep Speed** list. The options are **0.625 mm/s**, **50 mm/s**, **12.5 mm/s**, **25 mm/s**, and **50 mm/s**.

The smaller the value, the slower the sweep speed.

Setting CO₂ limit alarms

1. Select a gas related parameter window.
2. Select the **CO₂** tab > **Alarms**.
3. Set high and/or low limit values for **EtCO₂**, **FiCO₂** and **Respiration Rate**: select the parameter and then set the limits.

Deactivating the apnea alarm

NOTE This feature is meant to be used when ending CO₂ monitoring. It should not be used during active CO₂ monitoring.

This setting can be enabled during configuration. If it has been enabled, there will be a selection in the CO₂ **Setup** menu that allows you to deactivate the alarm:

1. Select a gas related parameter window.
2. Select the **CO₂** tab > **Setup**.
3. Select **Deactivate Apnea Alarm**.

NOTE When the alarm is deactivated, there will be no audible or visual **Apnea** alarm indications. The alarm is automatically reactivated if CO₂ vitals signs are detected and alarm condition is met again.

WARNING With deactivated **Apnea** alarm, keep the patient under close surveillance.

Apnea alarms' deactivation with the pause audio key

Apnea alarms can be deactivated with the pause audio key if the **Allow alarm deactivation with the Audio Pause key for:** setting **Apnea (CO2/Imped)** is enabled in the **Care Unit Settings**. This setting is password protected.

For more information, see the supplemental information manual.

Selecting what to show with EtCO₂

You can select which other gas measurement value appears in the parameter window with the EtCO₂.

1. Select a gas related parameter window.
2. Select the **CO2** tab > **Setup**.
3. Select an option from the **Show with EtCO2** list.

Selecting the FiO₂ level

NOTE E-miniC and OR, PACU, ED, and ICU software packages only.

NOTE FiO₂ and N₂O compensations must be selected manually when E-miniC is used.

The presence of a large concentration of oxygen causes the CO₂ level appear lower than the actual value. Use this option to compensate for the presence of O₂.

1. Select a gas related parameter window.
2. Select the **CO2** tab > **Setup**.
3. Select an option from the **FiO2 level** list.

Selecting the N₂O level

NOTE E-miniC and the anesthetic agent measurement license only. Available for OR, PACU, or ICU software packages.

NOTE FiO₂ and N₂O compensations must be selected manually when E-miniC is used.

The presence of N₂O causes the CO₂ value to appear higher than the actual value. Use this option to compensate for the presence of N₂O.

1. Select a gas related parameter window.
2. Select the **CO2** tab > **Setup**.
3. Select an option from the **N2O level** list.

Using the CARESCAPE respiratory modules and compact airway modules for O₂ measurement

Selecting the O₂ scale

If the difference between FiO₂ and EtO₂ is more than 6%, change the O₂ scale.

1. Select a gas related parameter window.
2. Select the **O2** tab > **Setup**.
3. Select an option from the **Scale** list.

Selecting the O₂ sweep speed

This selection affects the waveform.

1. Select a gas related parameter window.
2. Select the **O2** tab > **Setup**.
3. Select an option from the **O2 Sweep Speed** list. The options are **0.625 mm/s**, **6.25 mm/s**, **12.5 mm/s**, and **50 mm/s**.

The smaller the value, the slower the sweep speed.

Setting O₂ alarms

1. Select a gas related parameter window.
2. Select the **O2** tab > **Alarms**.
3. Check that the required alarm (**EtO2** or **FiO2**) is on, and set its high and/or low limit values.

Using the CARESCAPE respiratory modules and compact airway modules for AA and N₂O measurement

Selecting the agent scale

Every anesthetic agent has its own default scale that the monitor uses when detecting the agent. You can change the scale of an agent if the amount used is higher than the default scale. Default scales are given in the supplemental information manual.

1. Select a gas related parameter window.
2. Select the **Agent/N2O** tab > **Setup**.
3. Select an option from the **Agent Scale** list.

Selecting the agent sweep speed

This selection affects the waveform.

1. Select a gas related parameter window.

2. Select the **Agent/N2O** tab > **Setup**.
3. Select an option from the **Agent Sweep Speed** list. The options are: **0.625 mm/s**, **6.25 mm/s**, **12.5 mm/s**, **25 mm/s**, and **50 mm/s**.

The smaller the value, the slower the sweep speed.

Setting agent limit alarms

1. Select a gas related parameter window.
2. Select the **Agent/N2O** tab > **Alarms**.
3. Check that the required alarm (**EtAA** or **FiAA**) is on, and set its high and/or low limit values.

Gases alarm priorities

You can select priorities for the **CO2 high/low**, **FiAA high/low**, **RR (CO2) high/low**, and **Apnea (CO2)** alarms through **Alarm Setup > Alarm Priorities > Other Parameters**. The choices are **Medium**, **High**, and **Escalating**.

Preventing operating room pollution

When N₂O and volatile anesthetics are used, prevent operating room pollution by connecting the sample gas outlet (gas exhaust) of the module to the scavenging system.

Scavenging through the ventilator reservoir

1. Connect an exhaust line to the sample gas outlet (gas exhaust) on the module's front panel.
2. Attach the other end of the line to the ventilator reservoir. Make sure that the reservoir tube diameter is at least 2 to 3 times larger than the exhaust line.

Scavenging through the anesthesia gas scavenging system

Anesthesia machines are equipped with an anesthesia gas scavenging system (AGSS), and in some machines you can connect the sample gas outlet directly to it. See the anesthesia machine's user documentation to find out where and how the sample gas can be connected.

Connecting directly to the scavenging system

1. Connect the exhaust line to the module's sample gas outlet.
2. Connect the exhaust line only to an open scavenging system where gas is removed at room pressure.

NOTE Do not connect the module directly to a strong vacuum scavenging system.

NOTE If the E-miniC is used, do not return sample gas to the patient circuit.

Stopping the airway gases measurement

1. Remove the added adapters from the patient's breathing circuit and gas scavenging.
2. Check the patient's breathing circuit.
3. Remove the gas module from the monitor when it is not used.

Calibrating airway gases

Perform calibration every six months in normal use, once every two months in continuous use, and whenever there are indications of errors in the gas readings to ensure that the measurement accuracy remains within specifications.

NOTE Ensure that the calibration gas and regulator are functioning properly before calibration. Perform annual maintenance of the regulator as required.

NOTE Make sure that you are using a correct GE Healthcare calibration gas, see the supplemental information manual. Do not use any other calibration gases.

1. Turn on the patient monitor. For maximum accuracy, let the monitor warm up for 30 minutes.
2. Attach a regulator to the calibration gas cylinder.
3. Attach a new sampling line to the water trap. Connect the other end of the sampling line to the regulator on the gas container.
4. Select a gas related parameter window > **Calibration** tab.
5. Wait until the messages **Zero OK** and **Feed gas** appear after each gas on the screen.
6. Open the regulator and feed gas until the message **Adjust** appears, then close the valve.
7. Check that the displayed values match the values on the calibration gas container. Adjust if necessary:
 - a. Select the first gas to be adjusted.
 - b. Adjust the value until it matches the desired value on the gas container.
8. Confirm by selecting **Accept**
9. If the calibration is successful, the message **Calibration OK** is displayed for a few seconds. If the calibration fails, the message **Calibration error** appears instead. In this case, start a new calibration by selecting **Recalibrate**.

If the message **Zero error** appears, repeat the calibration procedure. If the problem persists, contact authorized service personnel.

Basics of airway gases measurement

Airway gases measurement description, CARESCAPE respiratory modules and compact airway modules

With CARESCAPE respiratory modules and compact airway modules, you can measure and monitor gases being delivered to the patient and exhaled by the patient through the breathing circuit. The modules consist of an infrared sensor for measuring CO₂ and N₂O, and paramagnetic O₂ sensor. The E-sCAiO, E-sCAiOV, E-CAiO, E-CAiOV and E-CAiOVX modules also include anesthetic agents measurement.

The gas sampling system samples the measured air to the module, and removes water and impurities from it. The pump of the gas sampling system draws gas at a fixed rate through the sampling line into the gas measuring units. The gas enters the module through the water trap, where it is divided into two flows, a main flow and a side flow. The main flow goes into the analyzers. This flow is separated from the patient side by a hydrophobic filter. The side flow creates a slight sub-atmospheric pressure within the water trap, which causes fluid removed by the hydrophobic filter to collect in the bottle. After the measurement, gas is exhausted through the sample gas out connector.

NOTE

The gas sampling system of the E-COVX and E-CAiOVX modules differs from that of the other compact airway modules and the CARESCAPE respiratory modules. A number of flow restrictors have been changed to create a bigger pressure difference with ambient pressure in the gas sensors. The sample flow is, however, approximately the same (200 ml/min). A larger pressure difference makes the deformations of the gas concentration curves less sensitive to high variations of the airway pressure.

Airway gases measurement description, E-miniC

The E-miniC is designed for critical care environment to measure and monitor the expired and inspired CO₂ concentration (EtCO₂, FiCO₂) as well as the respiration rate (RR) up to 80 breaths per minute. E-miniC has a sample flow of 150 ml/min.

Respiration rate from the CO₂ parameter is counted from the frequency of end-tidal (peak) CO₂ measurements per minute. A sufficient respiration is defined as a difference of at least 1% (at least 7 mmHg) between the measured inspired fraction and end-tidal CO₂.

Total sample size volume during one respiratory cycle depends on the respiration rate. The following table shows different sample size volumes with a 150 ml/min sample flow and I:E ratio of 1:2.

Respiration rate	10	20	30	40
Duration of inspiration	2.0 seconds	1.0 seconds	0.7 seconds	0.5 seconds
Duration of expiration	4.0 seconds	2.0 seconds	1.3 seconds	1.0 seconds
Volume sampled during inspiration	5 ml	2.5 ml	1.67 ml	1.25 ml

Volume sampled during expiration	10 ml	5 ml	3.33 ml	2.5 ml
Total volume sampled	15 ml	7.5 ml	5 ml	3.75 ml

Sidestream gas sampling

The E-modules use a sidestream gas sampling method. It means that a sample of patient's respired gases from the sampling site is transported through a sampling line to the module for analysis.

A sidestream gas analyzer takes a constant sample from the patient airway adapter at the following sample rates:

- CARESCAPE respiratory modules: 120 ml/min
- Compact airway modules: 200 ml/min
- E-miniC: 150 ml/min

Total sample size volume during one respiratory cycle depends on the respiration rate.

Minimum Alveolar Concentration (MAC)

NOTE CARESCAPE respiratory modules and compact airway modules only.

The use of either traditional MAC or MACage is selected during monitor configuration. The MACage provides age and temperature compensated measurement. To enable MACage calculations, enter patient's age to the monitor and attach a temperature sensor. If the patient's age is not given, the monitor shows normal MAC even if MACage has been selected.

NOTE The MAC value displayed by the monitor is that of exhaled air, and it does not always correspond to the amount of anesthetic in the patient's organs.

CAUTION Patient-specific MAC is affected by several factors such as patient age and body temperature.

MAC and MACage

The minimum alveolar concentration (MAC) concept is based on the assumption that in a steady state, the alveolar partial pressure of a gas is equal to the partial pressure in the effector organ of the central nervous system. MAC values are used to estimate the level of anesthesia caused by volatile anesthetics.

The MAC value can be displayed in a numeric parameter window: 1 MAC is the alveolar concentration (end-tidal) of the agent at which 50% of patients do not respond to a noxious or surgical stimulus. The value is calculated from the actual measured anesthetic agent and N₂O values with empirical formulas based on statistical studies with anesthetized patients.

The monitor can display two different MAC values, MAC or MACage, based on different formulas. The use of MAC or MACage is selected during installation and configuration.

The MAC values correspond to those of healthy adults of about 40 years old, and cannot be applied to children or elderly patients. Age and some other individual factors influencing the effect of volatile agents are not taken into account.

The other calculation method, MACage, takes the patient's age into account. The age range is 0 to 150 years. The calculation uses 0 if age is less than 0, and 100 if age is more than 100. In addition, MACage calculations include the atmospheric pressure and the patient's (highest measured) temperature values. If no patient temperature is measured, 37°C is used instead. For volatile agents this calculation method means about 6.7% decrease of MAC value with each increasing decade of life. MACage is calculated if it is enabled in the care unit settings and the patient's age is given on the monitor. If no age is given, MAC is calculated despite the care unit setting.

References used for MAC and MACage values

The alveolar concentrations of traditional (MAC) and age dependent (MACage) values are based on the following references:

- References for anesthetic agent MAC values:
 - Mapleson W.W.: Effect of age on MAC in humans: a meta-analysis. *Br. J. of Anaesthesia* 1996; 76: 179-185
 - Rampil I.J.; Zwass M.; Lockhart S.; Eger E.I. II; Johnson B.H.; Yasuda N.; Weiskopf R.B.: MAC of I653 in surgical patients, *Anesthesiology*. Tram-Rac71 (3A):A269, September 1989
 - Scheller M.S., Partridge B.L., Saidman L.J.: MAC of sevoflurane in humans and the New Zealand white rabbit. *Anesthesiology* 1987; 67: A373
 - ISO21647:2004 + C1:2005, Medical electrical equipment - Particular requirements for the basic safety and essential performance of respiratory gas monitors.
- References for MACage calculations:
 - Eger, E.I. II.: Age, minimum alveolar anesthetic concentration, and minimum alveolar anesthetic concentration-awake. *Anesth. Analg.* 2001; 93:947-953
 - Rampil I.J.; Zwass M.; Lockhart S.; Eger E.I. II; Johnson B.H.; Yasuda N.; Weiskopf R.B.: MAC of I653 in surgical patients, *Anesthesiology*. 71 (3A):A269, September 1989

MAC values of different anesthetics in oxygen

Normal values (40-year-old patient) and compensated values (65-year-old and 3-year-old patients):

	1 MAC	1 MAC (65 yrs)	1 MAC (3 yrs)
Halothane	0.75%	0.63%	0.97%
Enflurane	1.70%	1.43%	2.2%
Isoflurane	1.15%	0.97%	1.5%
Sevoflurane	2.05%	1.73%	2.65%
Desflurane	6.00%	5.05%	7.80%
N ₂ O	100%	82%	N/A

The following illustration shows the Agent% corresponding to 1 MAC as function of age:

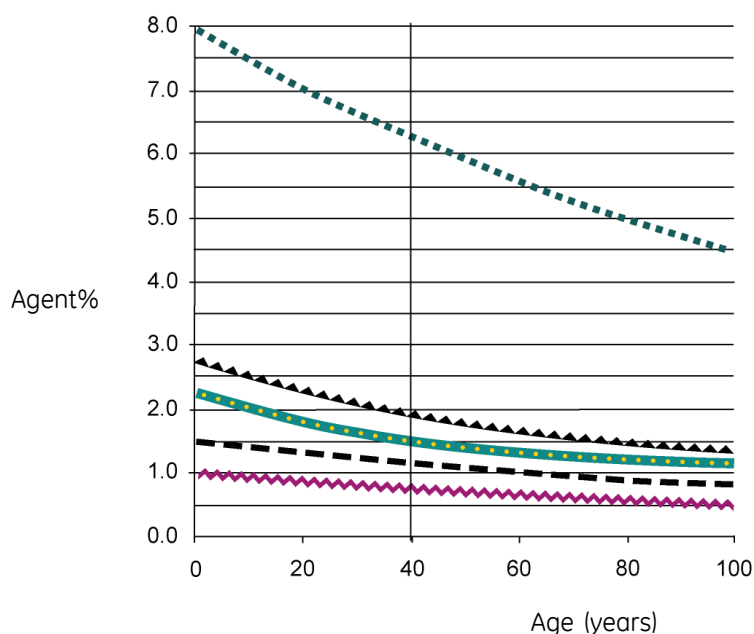

Symbol	Anesthetic
.....	Desflurane
▲▲▲▲▲	Sevoflurane
.....	Enflurane
-----	Isoflurane
~~~~~	Halothane

## MAC values of different anesthetics in 65% N₂O

Normal values (40-year-old patient) and compensated values (65-year-old and 3-year-old patients).

	1 MAC	1 MAC (65 yrs)	1 MAC (3 yrs)
Halothane	0.27%	0.14%	0.51%
Enflurane	0.61%	0.31%	1.15%
Isoflurane	0.41%	0.21%	0.78%
Sevoflurane	0.73%	0.37%	1.40%
Desflurane	2.09%	1.1%	4.1%

## ET balance gas, CARESCAPE respiratory modules and compact airway modules

You can obtain a calculated value for balance gas, EtBal. End-tidal balance gas is the percentage of gas concentration not measured by the gas sensors. It is displayed in a parameter window with the MAC value.



An increased balance gas value may indicate the amount of nitrogen flushed out from the patient into the circuit. The increase may be due to an accumulation of nitrogen during low flow anesthesia.

The monitor calculates end-tidal balance gas when oxygen and CO₂ measurements are active. If oxygen or CO₂ status is invalid or agent identification fails, the monitor displays the balance gas value as invalid.

## Automatic agent identification with E-sCAiO, E-sCAiOV, E-CAiO, E-CAiOV and E-CAiOVX modules

The E-modules with agent identification option will automatically identify and select Isoflurane, Desflurane, Sevoflurane, Enflurane and Halothane. The modules are able to identify two agents simultaneously and displaying them as primary and secondary agents. The inspiratory and expiratory concentrations of the agent are displayed in a numeric parameter window. Minimum concentration for the identification is 0.15 vol%. The agent selection remains active even if the concentration decreases below 0.15 vol%. Automatic agent identification is operational after the normal warm up of the module (approximately five minutes).

- If rapid agent concentration changes are required, fresh gas flow must be increased.
- Anesthetic agent concentration in the circuit is affected by patient uptake, breathing system volume and the fresh gas flow. It quantifies the speed of wash-in and wash-out anesthetic agents.

## Basics of CO₂ measurement

### Normal CO₂ waveform

The CO₂ waveform is referred to as capnogram and it reflects the different stages in breathing. The capnogram of a healthy patient under controlled ventilation has a normal shape. Changes in the CO₂ waveform may indicate compromised patient respiratory and/or circulatory function or improper mechanical ventilator functionality.

### The origin of the CO₂ waveform

The following illustration shows a normal capnogram. In this illustration, the letters indicate the following:

- A: The gas first exhaled is from the anatomical and apparatus dead-space. It contains no CO₂ because it has not been in the alveoli and no gas exchange has taken place.
- B: Briefly, the exhaled gas is a mixture of gas from the anatomical dead-space and gas from the alveoli.
- C: A plateau is reached when the gas exhaled is entirely from the alveoli. The end-tidal CO₂ (EtCO₂) concentration is measured at the end of this plateau.
- D: When the next inspiration starts the capnogram rapidly falls towards the baseline. The minimum level of CO₂ measured during the inspiratory phase is called the inspired CO₂ concentration (normally 0.0%).

- E: With a scale, the height of the capnogram tells you the end-tidal CO₂ concentration. The monitor automatically calculates and display the EtCO₂ in numbers. EtCO₂ approximates the alveolar CO₂ concentration because it is measured when the patient exhales virtually pure alveolar gas.

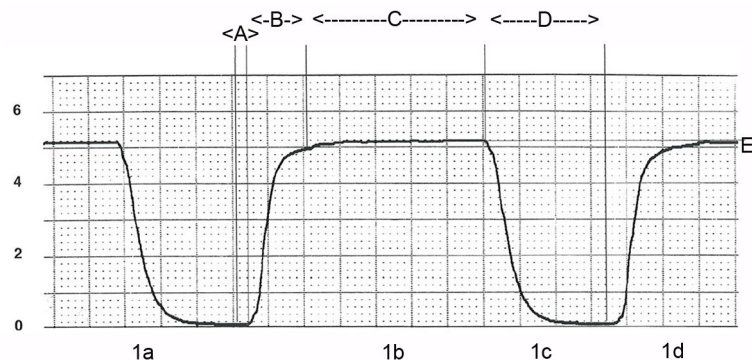

- 1a and 1d = inhalation
- 1b and 1c = exhalation

EtCO ₂ value %	EtCO ₂ value mmHg	Indicates
4.5% to 5.5%	34 mmHg to 41 mmHg	normocapnia
< 4%	< 30 mmHg	hypocapnia
> 6%	> 45 mmHg	hypercapnia

## Dips in capnogram

The dips seen in the capnogram during expiration are related to the sidestream gas sampling, the continuous gas flow to the Y-piece, and patient's cardiac contractions, which cause intra-thoracic pressure changes and therefore flow variations.

The alterations in expired CO₂ waveform are cardiogenic movements of exhaled and circuit gas at the sidestream gas sampling site. When the respiratory gas flow drops below the gas sampling rate, a variable mixture of CO₂ free fresh gas and exhaled CO₂ rich gas is sampled. This causes variations in sampled CO₂ concentrations.

In the illustration below, CO₂ waveform is the one on top, and flow is the lower waveform.

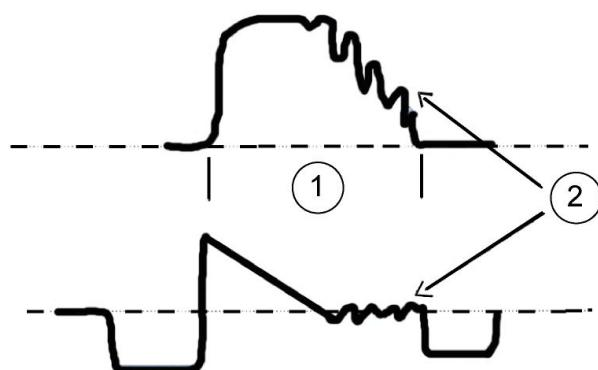

1. Expiration
2. Cardiogenic oscillations

Cardiogenic oscillations appear when:

- A continuous fresh gas flow is fed into the patient Y-piece.
- Sidestream gas sampling is done at the Y-piece.
- The patient is ventilated with a long expiration time or low respiration times, and when there is a long zero flow at end-expiration for some other reason.

Oscillations can be eliminated by adding a spacer with a 5 ml dead space between the Y-piece and the airway adapter. Increased dead space creates a buffer volume between the Y-piece and the sampling point, preventing the inspiratory and expiratory air from mixing during gas sampling. Misinterpretation of EtCO₂ information can be avoided through identifying cardiogenic oscillation and understanding the reasons for it.

## Oxygen measurement interpretation, CARESCAPE respiratory modules and compact airway modules

The CARESCAPE respiratory modules and compact airway modules oxygen measurement provides:

- Inspired oxygen level, the actual inspired oxygen concentration
- End-tidal oxygen level, the expired oxygen concentration
- Inspiratory-expiratory oxygen difference reflects patient's consumed oxygen volume-percentage from the administered gas mix
- Oxygram, a diagnostic tool both in real time and as a trend

The patient oxygen provides breath-by-breath information about the breathing circuit, alveolar ventilation and some vital indicators of adequate oxygenation.

Oxygram is a mirror image of a capnogram in a steady state in normal patient. It is a graphic presentation of changes in O₂ concentrations in the airway gas. The oxygram reflects the oxygen uptake from the alveoli. To avoid patient administered hypoxic gas mixes the inspired fraction of oxygen (FiO₂) should never be lower than 21%.

## Airway gases practicalities

### Ventilation management

Normoventilation (adequate alveolar ventilation of a patient) can be maintained by monitoring the end-tidal carbon dioxide and oxygen concentrations, and adequacy of ventilation can be maintained by monitoring airway pressures, volumes and spirometry loops. Alveolar minute ventilation is usually adjusted to achieve normocapnia, where EtCO₂ is in the range of 4.5% to 5.5% (34 mmHg to 41 mmHg). This is called normoventilation as it is the normal situation in healthy people.

A low EtCO₂ concentration (EtCO₂ < 4% / 30 mmHg) indicates hyperventilation.

#### NOTE

A low EtCO₂ value in itself is dependent from the ventilation volume vs. circulation status (lung perfusion). This means that in case of low blood pressure (e.g. shock) or shunting low EtCO₂ values may be observed while using a "normal" TV/MV.

Increased EtCO₂ concentration (EtCO₂ > 6.0% / 45 mmHg) indicates hypoventilation or ineffective alveolar ventilation, which will lead to hypercapnia and respiratory acidosis. Increased inspiratory CO₂ (FiCO₂) concentrations may also be caused by:

- Exhausted CO₂ absorber.
- Malfunction of the breathing system valves.
- Rebreathing when a rebreathing system without a CO₂ absorber is used with inadequate fresh gas flows.

**NOTE** During some surgical procedures, e.g. laparoscopy, CO₂ may be used to inflate the abdomen which may result in rise of PaCO₂ due to the absorption of CO₂ into the blood via the vascular wound bed. This may lead to an increase in the EtCO₂.

## Prevention of the breathing system contamination

You can use a microbial filter between the endotracheal tube and the airway adapter. Change the filter for every patient. Change the patient circuit at intervals given in the circuit manufacturer's documentation, and according to your hospital protocols.

## How to prevent effects of humidity

In anesthesia, the lower the fresh gas flow, the more rebreathed gas recirculates through the CO₂ absorber and the more humidity and heat is produced through the chemical CO₂ absorption process.

- If a moisture exchanger is used, place it between the endotracheal or intubation tube and the airway adapter. In intensive care, the moisture exchanger must be replaced at least every 24 hours.
- Place all airway adapter ports upwards with a 20° to 45° tilt to prevent condensed water from entering the sensor interior and the tubings.
- The airway adapter should be emptied of clearly visible water droplets, or replaced with a dry and clean adapter.
- If active humidification is used, extra water collectors may be placed between the ventilator's inspiratory and expiratory breathing tubings. They are also useful for condensed water collection during long-lasting anesthesia.

## Oxygen delivery, CARESCAPE respiratory modules and compact airway modules

### Oxygen uptake and consumption

Oxygen consumption is the difference between the amount of oxygen delivered to the tissues by the arterial circulation and the amount of oxygen returned to the heart by the venous system. The formula for oxygen consumption is a simple restatement of the Fick equation, which identifies all of the pertinent variables of oxygen supply and demand.  $VO_2 = CO \times Hb \times 13.8 \times (SaO_2 - SvO_2)$ . Dependent from the patient's circulation status the mechanical ventilator settings for, amongst others, FiO₂ in the delivered gas mix (min. > 25%) should guarantee a sufficient PAO₂ and PaO₂. Patients with fever may consume oxygen at considerably higher rates.

Oxygen supply to the breathing system must meet the metabolic need of the patient.

To prevent hypoxemia and to ensure safe and sufficient oxygen supply, the alveolar oxygen concentration (EtO₂) should be at the level of 25% minimum.

### Nitrogen elimination

During the maintenance of minimal low flow anesthesia, a small amount of nitrogen may accumulate in the circuit. It may be detected as decreased concentration of other gases, and eliminated by temporarily increasing the fresh gas flow.

### Flow reduction

Reduction of fresh gas flow may increase rebreathing in case of a CO₂ absorber malfunction or during the use of open anesthesia gas delivery systems.

The lower the fresh gas flow, the higher the oxygen concentration required in the fresh gas.

## Level of anesthesia: E-sCAiO, E-sCAiOV, E-CAiO, E-CAiOV, E-CAiOVX

### Anesthetic agent uptake

Fresh gas flow reduction decreases the total amount of anesthetic agent fed into the breathing system if agent concentration is maintained constant.

The lower the fresh gas flow rate, the longer the time required to reach the effect of a change in the fresh gas settings.

## Airway gases troubleshooting

Problem	Solution
Airway gas values are too low	<ul style="list-style-type: none"> <li>• Check the sampling line and connectors for leakage.</li> <li>• Check the patient status.</li> </ul>
Airway gas values are too high	<ul style="list-style-type: none"> <li>• Check the sampling line for blockage.</li> <li>• Check the patient status.</li> </ul>
Module does not work	<ul style="list-style-type: none"> <li>• Check and clean the filter if necessary.</li> <li>• Check the water trap container. If it is too full, liquid may have entered the module. Replace the module and have it checked by authorized service personnel.</li> </ul>
No airway gas values	<ul style="list-style-type: none"> <li>• Check that the gas sampling line is connected to the water trap.</li> <li>• Check that the gas sampling line is connected to the patient.</li> </ul>
Why can we see dips in the capnogram during expiration?	<ul style="list-style-type: none"> <li>• The dips seen in the capnogram during expiration are related to the sidestream gas sampling, the continuous gas flow to the Y-piece, and patient's cardiac contractions, which cause intra-thoracic pressure changes and therefore flow variations.</li> </ul>

## Airway gases

Problem	Solution
Why can we see variations in the oxygram during inspiration?	<ul style="list-style-type: none"><li>• Changes in the fresh gas flow reate and oxygen concentrations affect the shape of the oxygram during inspiration. Rule out any potential clinical complications such as hypoventilation, hyperventilation, circuit hypoxia, disconnection.</li></ul>
Why is the EtCO ₂ value considerably lower than the CO ₂ partial pressure determined by blood gas analysis?	<ul style="list-style-type: none"><li>• The major clinical reasons are dead-space ventilation, ventilation/perfusion mismatch, a drop in cardiac output, alveolar shunts, and incomplete emptying of the alveoli.</li><li>• Also check the following technical issues: integrity of the breathing circuit; blood-gas analysis corrected to a lower temperature in case of hypothermia.</li></ul>

# 17

## CO₂ with CAPNOSTAT Mainstream, CapnoFlex LF, and Dual CO₂ modules

### CO₂ compatibility limitations

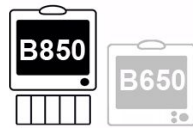

CAPNOSTAT Mainstream, CapnoFlex LF and Dual CO₂ modules with the B850 only.

For detailed information regarding module, monitor, and accessory compatibility, see the supplemental information manual.

### CO₂ safety precautions

#### CO₂ warnings

- WARNING** Always inspect the airway adapter for a tight connection and proper operation before attaching it to the patient.
- WARNING** Leaks in the gas sampling circuit (water trap and sampling line) may cause inaccurate readings.
- WARNING** Remove the airway sampling line from the patient's airway while nebulized medications are being delivered.
- WARNING** Handle the water trap and its contents as you would any body fluid. Infectious hazard may be present.
- WARNING** Since sample gas may contain anesthetic agents, make sure that it is not released in the room. Connect exhaust to a scavenging system to prevent exposure to anesthetic agents.
- WARNING** Route all tubing away from the patient's throat to avoid strangulation.
- WARNING** To avoid the spread of infectious disease, do not allow the exhaust to discharge in the direction of the patient or user.
- WARNING** CapnoFlex LF or CAPNOSTAT modules: O₂, N₂O and anesthetic agent gases may interfere with EtCO₂ readings.

- WARNING** Do not use a CO₂ module at the same time as a compact airway module or a CARESCAPE respiratory module.
- WARNING** Do not wash, disinfect or open the water trap cartridge.
- WARNING** To avoid the risk of patient cross-infection, do not return the sampled gas to the breathing system.
- WARNING** Strong scavenging suction may change the operating pressure of the module and cause inaccurate readings or excessive sample gas flow.
- WARNING** CAPNOSTAT or CapnoFlex LF: Do not allow the exhaust line to become kinked or blocked. Back pressure may cause inaccurate gas readings.
- WARNING** Dual CO₂ module: — WATER TRAP — An Aqua-Knot water trap must always be used when the unit is running. Failure to use the water trap can result in contamination of the internal gas measurement instruments and cause subsequent inaccurate gas analysis data. Replace and dispose of the Aqua-Knot water trap when occluded. Do not reuse. Reusing the water trap may cause inaccurate readings and may damage the equipment.
- WARNING** The CAPNOSTAT and CapnoFlex LF CO₂ monitoring devices should not be used in close proximity to wireless networking equipment, or in the presence of strong electromagnetic fields such as those generated by radio station transmitters, citizens band radios, cellular phones, etc. Using a CAPNOSTAT or CapnoFlex LF sensor under the above conditions may cause one or all of the following to occur:
- Artifact may be induced on the capnogram.
  - The CO₂ parameter values may be replaced by —.
  - A message prompting to check or calibrate the adapter or to check the sample line may be displayed in the parameter window.
- Normal operation will resume when the source of interference is removed.
- WARNING** CAPNOSTAT: Always position the sensor with the adapter in an upright position to avoid collection of fluids on the windows of the adapter. Large concentration of fluids at this point will obstruct gas analysis.
- WARNING** The CapnoFlex LF module generates an alarm for low flow rate when the flow drops to approximately 50% of the nominal flow rate of 50 ml/min. This rate is slightly below the lowest specified flow rate of 40 ml/min.
- WARNING** Dual CO₂ module: — CONTAMINATION — Be sure the pump is off before removing the Aqua-Knot water trap to prevent contamination of the internal gas measurement instrument.



- WARNING** CAPNOSTAT: A zero cell calibration is required each time a sensor is connected. Failure to do so can result in inaccurate CO₂ values.
- WARNING** CapnoFlex LF: Do not use this module on patients that cannot tolerate the removal of 50 ml/min from their total minute ventilation.
- WARNING** Dual CO₂: Do not use this module on patients that cannot tolerate the removal of 180 ml/min from their total minute ventilation.
- WARNING** CAPNOSTAT: Failure to configure the atmospheric pressure correctly will lead to inaccurate CO₂ readings in mmHg and kPa.

## CO₂ cautions

- CAUTION** Do not apply pressurized air or gas to any outlet or tubing connected to the monitor. Pressure may destroy sensitive elements.

## CO₂ points to note

Make sure that you are using a water trap that is compatible with the module:

- Dual CO₂: AquaKnot
- CAPNOSTAT Mainstream: no water trap
- CapnoFlex LF CO₂: contained in sample lines.

## CO₂ measurement setup

### Equipment connection with CAPNOSTAT Mainstream module

- WARNING** Do not plug the CAPNOSTAT Mainstream EtCO₂ sensor into the Solar CapnoFlex Adapter. Plug the sensor directly into the Mainstream EtCO₂ module or the Dual CO₂ module.

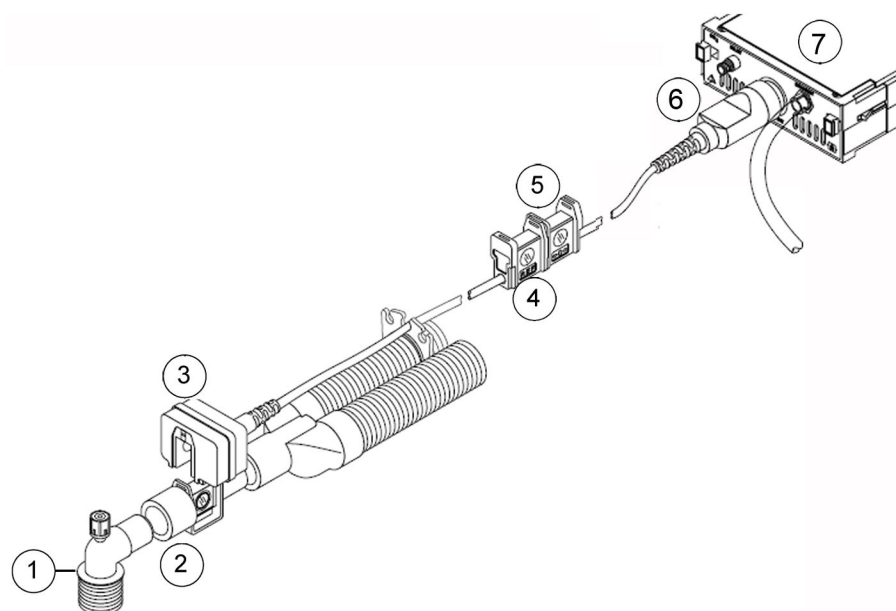

1. Airway adapter to patient endotracheal tube
2. Mainstream adapter
3. Mainstream sensor (upright position)
4. Reference cell
5. Zero cell
6. Sensor cable
7. Module

## Preparing the setup for CAPNOSTAT Mainstream module

For intubated patients.

1. Snap the airway adapter on to the mainstream sensor.
2. Connect the sensor to the module. The message **Warming up** is displayed on the monitor screen. Wait until it disappears.
3. Confirm that the monitor's atmospheric pressure setting is correct.
4. Check the monitor screen. If the message **Check/calibr. adapter** appears, perform adapter calibration.
5. Position the adapter and sensor in upright position in the patient breathing circuit as close to the patient as possible.

## Calibrating the CAPNOSTAT Mainstream sensor

Sensor calibration should be performed whenever the message **Calibrate sensor** appears.

1. Place the sensor away from all sources of CO₂, including the patient's exhaled breath, your exhaled breath, and ventilator exhaust valves.
2. With the cable connected to the module, select a gas related parameter window.
3. Select the **Calibration** tab.

4. Place the sensor on the cell marked **0** and select **Start Zeroing**.
5. After the message **Zeroed** appears, remove the sensor from the **0** cell and attach it to the cell marked **REF**.

The measured EtCO₂ value appears in the **Connect sensor to REF cell** window. If the value stays between 36 and 40 mmHg for three seconds during the 20-second calibration, the calibration is successful and the message **Calibrated** appears. If the calibration fails, the message **Recalibrate** appears instead. In this case, perform a new calibration.

## Calibrating the CAPNOSTAT Mainstream adapter

Adapter calibration should be performed whenever the message **Check/calibr. adapter** appears.

1. Place the sensor and adapter away from all sources of CO₂, including the patient's exhaled breath, your exhaled breath, and ventilator exhaust valves.
2. With the adapter connected to the sensor and the sensor connected to the monitor (and, when used, all sidestream tubing attached and the pump turned on), select the gases parameter window.
3. Select the **Calibration** tab.
4. Select **Start Calibrating**.

The message **Calibrated** appears on the screen after a successful calibration. If the calibration fails, the message **Calibration error** appears instead. In this case, perform a new calibration.

## Equipment connection with CapnoFlex LF module

For intubated and non-intubated patients.

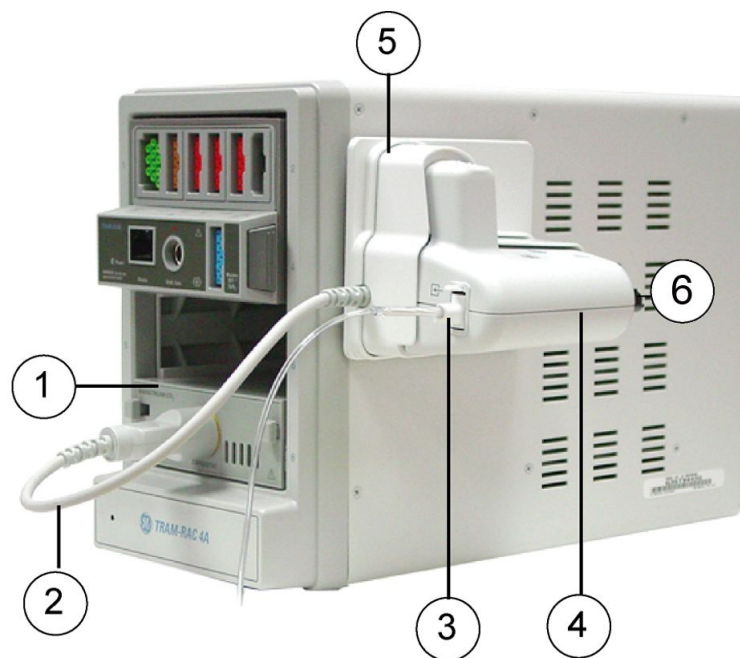

1. CAPNOSTAT Mainstream or Dual CO₂ module
2. Adapter cable

3. Accessory port (for sample lines, nasal cannulas etc.)
4. CapnoFlex LF module
5. CapnoFlex LF adapter
6. Exhaust line

## Preparing the setup for CapnoFlex LF module

1. Make sure the CapnoFlex LF adapter is attached to the Tram-Rac.
2. Plug the CAPNOSTAT Mainstream or Dual CO₂ module into the Tram-Rac.
3. Plug the adapter cable into the CAPNOSTAT Mainstream or Dual CO₂ module.
4. Connect the sample line to the CapnoFlex LF module but not to the patient.
5. Connect the CapnoFlex LF module into the CapnoFlex LF adapter. The message **Warming up** appears on the screen. Wait until it disappears.
6. If the message **Calibrate sensor** appears, perform calibration.
7. Block the open end of the sample line or nasal cannula. The message **Sample line blocked** should appear within 60 seconds on the monitor display to ensure that the monitor recognizes blockages.
8. Remove the sample line from the CapnoFlex LF module and reinsert it to return the module to normal operation.
9. Connect the sample line to the patient's breathing circuit.

## Calibrating the CapnoFlex LF adapter

CapnoFlex LF adapter calibration should be performed whenever the message **Check/calibr. adapter** appears.

1. Place the sample line away from all sources of CO₂, including the patient's exhaled breath, your exhaled breath, and ventilator exhaust valves.
2. With the adapter connected to the sensor, the sensor connected to the monitor, and the pump turned on, select a gas related parameter window.
3. Select the **Calibration** tab.
4. Select **Start Calibrating**.

The message **Calibrated** appears on the screen after a successful calibration. If the calibration fails, the message **Calibration error** appears instead. In this case, perform a new calibration.

## Equipment connection with Dual CO₂ module

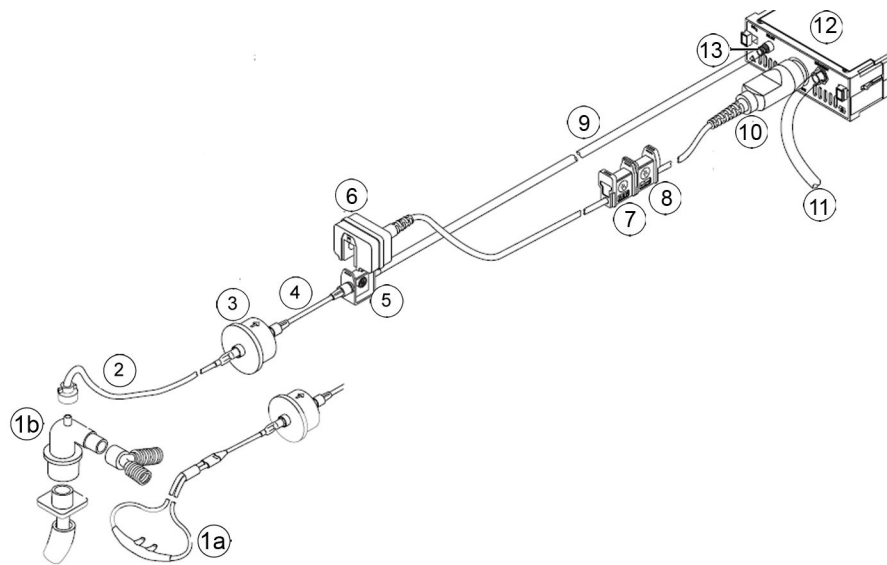

1. Nasal cannula (1a, non-intubated patients) or airway adapter (1b, intubated patients)
2. Patient sample line (intubated patients)
3. Water trap
4. 12.7 cm (5 in) male/male adapter tubing
5. Sidestream adapter
6. Sensor (upright position)
7. Reference cell
8. Zero cell
9. Sidestream adapter tubing
10. Sensor cable
11. Scavenging tube
12. Module
13. Sidestream inlet connector

## Preparing the sidestream setup with Dual CO₂ module

1. Connect the sidestream adapter tubing to the inlet connector on the module.
2. Connect the scavenging tube to the exhaust connector if N₂O or volatile agents are used.
3. Attach the 12.7-cm (5-in) adapter tubing connector to the airway adapter.
4. Secure the water trap to the adapter tubing.
5. Connect the nasal cannula or sample line to the water trap.
6. Snap the sidestream adapter with its tubing into the sensor.
7. Connect the sensor cable to the module. The message **Warming up** appears on the monitor screen. Wait until it disappears.
8. Turn on the pump.

9. Check the monitor screen. If the message **Calibrate sensor** appears, calibrate the sensor. If the message **Check/calibr. adapter** appears, calibrate the adapter.
10. Block the open end of the sample line or nasal cannula. Within 90 seconds the pump will shut off and the message **Sample line blocked** should appear on the monitor display to ensure that the monitor recognizes blockages.
11. To turn the pump back on and return to normal operation, turn the pump off and then back on again in the CO₂ setup menu. The pump will turn back on and the module will return to normal operation.
12. Connect the sample line to the patient. Ensure that the tubing is not hanging lower than the patient.

**NOTE** Delivery of bronchodilators and/or mucolytics via aerosol and meter dose inhalers can be corrosive and cause premature blockage of the water trap. Discontinue sidestream gas analysis prior to treatment by switching the pump off and removing the sample line from the breathing circuit.

## Calibrating the Dual CO₂ sensor

Sensor calibration should be performed whenever the message **Calibrate sensor** appears.

1. Place the sensor away from all sources of CO₂, including the patient's exhaled breath, your exhaled breath, and ventilator exhaust valves.
2. With the cable connected to the module, select a gas related parameter window > **Calibration**.
3. Place the sensor on the cell marked **0** and select **Start Calibrating**.
4. After the message **Zeroed** appears, remove the sensor from the **0** cell and attach it to the cell marked **REF**.

The measured EtCO₂ value appears in the **Connect sensor to REF cell** window. If the value stays between 36 and 40 mmHg for three seconds during the 20-second calibration, the calibration is successful and the message **Calibrated** appears. If the calibration fails, the message **Recalibrate** appears instead. In this case, perform a new calibration.

## Calibrating the Dual CO₂ adapter

Adapter calibration should be performed whenever the message **Check/calibr. adapter** appears.

1. Place the sensor and adapter away from all sources of CO₂, including the patient's exhaled breath, your exhaled breath, and ventilator exhaust valves.
2. With the adapter connected to the sensor and the sensor connected to the monitor (and, when used, all sidestream tubing attached and the pump turned on), select a gas related parameter window.
3. Select the **Calibration** tab.
4. Select **Start Calibrating**.

The message **Calibrated** appears on the screen after a successful calibration. If the calibration fails, the message **Calibration error** appears instead. In this case, perform a new calibration.

# Using the CO₂ measurement

## Available menu selections

**NOTE** Available menu selections may differ according to the modules and/or software packages. Please read the following instructions carefully. If nothing is mentioned about the availability of the selection, it is the same for all modules and/or software packages.

## Selecting the CO₂ scale

If EtCO₂ is above 6% (45 mmHg), change the scale for capnogram.

1. Select a gas related parameter window.
2. Select the **CO₂** tab > **Setup**.
3. Select an option from the **Scale** list.

## Selecting the CO₂ sweep speed

This selection affects the waveform.

1. Select a gas related parameter window.
2. Select the **CO₂** tab > **Setup**.
3. Select an option from the **CO₂ Sweep Speed** list. The options are **0.625 mm/s**, **50 mm/s**, **12.5 mm/s**, **25 mm/s**, and **50 mm/s**.

The smaller the value, the slower the sweep speed.

## Setting CO₂ limit alarms

1. Select a gas related parameter window.
2. Select the **CO₂** tab > **Alarms**.
3. Set high and/or low limit values for **EtCO₂**, **FiCO₂** and **Respiration Rate**: select the parameter and then set the limits.

## Deactivating the apnea alarm

**NOTE** This feature is meant to be used when ending CO₂ monitoring. It should not be used during active CO₂ monitoring.

This setting can be enabled during configuration. If it has been enabled, there will be a selection in the CO₂ **Setup** menu that allows you to deactivate the alarm:

1. Select a gas related parameter window.
2. Select the **CO₂** tab > **Setup**.
3. Select **Deactivate Apnea Alarm**.

**NOTE** When the alarm is deactivated, there will be no audible or visual **Apnea** alarm indications. The alarm is automatically reactivated if CO₂ vitals signs are detected and alarm condition is met again.

**WARNING**

With deactivated **Apnea** alarm, keep the patient under close surveillance.

## Apnea alarms' deactivation with the pause audio key

Apnea alarms can be deactivated with the pause audio key if the **Allow alarm deactivation with the Audio Pause key for:** setting **Apnea (CO₂/Imped)** is enabled in the **Care Unit Settings**. This setting is password protected.

For more information, see the supplemental information manual.

## Selecting CO₂ average

You can select a time interval for averaging the CO₂.

1. Select a gas related parameter window.
2. Select the **CO₂** tab > **Setup**.
3. Select an option from the **CO₂ Average** list.

## Selecting the FiO₂ level

The presence of a large concentration of oxygen causes the CO₂ level appear lower than the actual value. Use this option to compensate for the presence of O₂.

1. Select a gas related parameter window.
2. Select the **CO₂** tab > **Setup**.
3. Select an option from the **FiO₂ level** list.

## Selecting the N₂O level

**NOTE**

With the anesthetic agent measurement license only.  
Available for OR, PACU or ICU software packages only.

The presence of N₂O causes the CO₂ value to appear higher than the actual value. Use this option to compensate for the presence of N₂O.

1. Select a gas related parameter window.
2. Select the **CO₂** tab > **Setup**.
3. Select an option from the **N₂O level** list.

## Selecting the pump on or off

The pump must be on when using the sidestream method. Note also that a blocked line may cause the pump to shut off automatically.

### Pump on or off with the CapnoFlex LF module

The pump is automatically turned on when a sample line is inserted into the CapnoFlex LF module. The pump turns off when the sample line is removed.

### Selecting pump on or off with the Dual CO₂ module

1. Select a gas related parameter window.
2. Select the **CO₂** tab > **Setup**.
3. Select **On** or **Off** from the **Pump** list.



## Selecting apnea alarm limit

The apnea alarm can be enabled to select a time delay before an apnea alarm is generated. The delay is defined with the **Apnea Limit Seconds** setting. If anything else than the default (20 seconds) is selected, the apnea alarm displays in the parameter window with the number of seconds selected for the delay.

1. Select a gas related parameter window.
2. Select the **CO₂** tab > **Setup**.
3. Select an option from the **Apnea Limit Seconds** list.

## Preventing operating room pollution with CAPNOSTAT Mainstream, Dual CO₂, and CapnoFlex LF modules

When N₂O and volatile anesthetics are used, prevent operating room pollution by connecting the monitor's sample gas outlet to the scavenging system or by returning the sample gas to the patient circuit.

### Scavenging to scavenging systems

The gas exhaust may be scavenged using the scavenging adapter package.

1. Remove the exhaust adapter and tube from the package.
2. Attach the connector end of the exhaust tube to the module outlet marked **EXHAUST**.
3. Install the exhaust adapter into the gas scavenging system of the anesthesia delivery system, following the anesthesia machine manufacturer's recommended procedure.
4. Drape the exhaust tube so that it does not interfere with the work area.

## Stopping the CO₂ measurement

1. Remove the added adapters from the patient's breathing circuit and gas scavenging.
2. Check the patient's breathing circuit.
3. Remove the gas module from the monitor when it is not used.

## Basics of CO₂ measurement

### Normal CO₂ waveform

The CO₂ waveform is referred to as capnogram and it reflects the different stages in breathing. The capnogram of a healthy patient under controlled ventilation has a normal shape. Changes in the CO₂ waveform may indicate compromised patient respiratory and/or circulatory function or improper mechanical ventilator functionality.

## The origin of the CO₂ waveform

The following illustration shows a normal capnogram. In this illustration, the letters indicate the following:

- A: The gas first exhaled is from the anatomical and apparatus dead-space. It contains no CO₂ because it has not been in the alveoli and no gas exchange has taken place.
- B: Briefly, the exhaled gas is a mixture of gas from the anatomical dead-space and gas from the alveoli.
- C: A plateau is reached when the gas exhaled is entirely from the alveoli. The end-tidal CO₂ (EtCO₂) concentration is measured at the end of this plateau.
- D: When the next inspiration starts the capnogram rapidly falls towards the baseline. The minimum level of CO₂ measured during the inspiratory phase is called the inspired CO₂ concentration (normally 0.0%).
- E: With a scale, the height of the capnogram tells you the end-tidal CO₂ concentration. The monitor automatically calculates and display the EtCO₂ in numbers. EtCO₂ approximates the alveolar CO₂ concentration because it is measured when the patient exhales virtually pure alveolar gas.

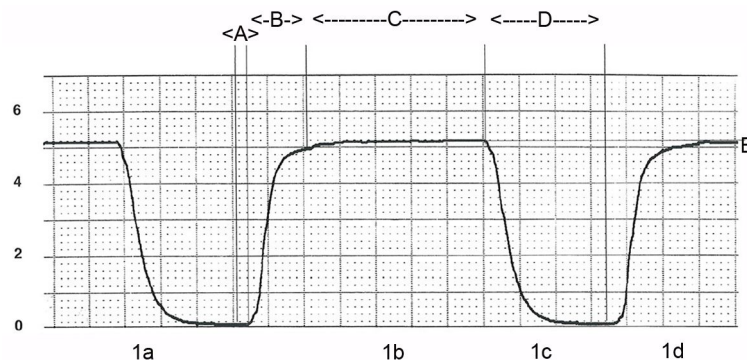

- 1a and 1d = inhalation
- 1b and 1c = exhalation

EtCO ₂ value %	EtCO ₂ value mmHg	Indicates
4.5% to 5.5%	34 mmHg to 41 mmHg	normocapnia
< 4%	< 30 mmHg	hypocapnia
> 6%	> 45 mmHg	hypercapnia

## Dips in capnogram

The dips seen in the capnogram during expiration are related to the sidestream gas sampling, the continuous gas flow to the Y-piece, and patient's cardiac contractions, which cause intra-thoracic pressure changes and therefore flow variations.

The alterations in expired CO₂ waveform are cardiogenic movements of exhaled and circuit gas at the sidestream gas sampling site. When the respiratory gas flow drops below the gas sampling rate, a variable mixture of CO₂ free fresh gas and exhaled CO₂ rich gas is sampled. This causes variations in sampled CO₂ concentrations.

In the illustration below, CO₂ waveform is the one on top, and flow is the lower waveform.

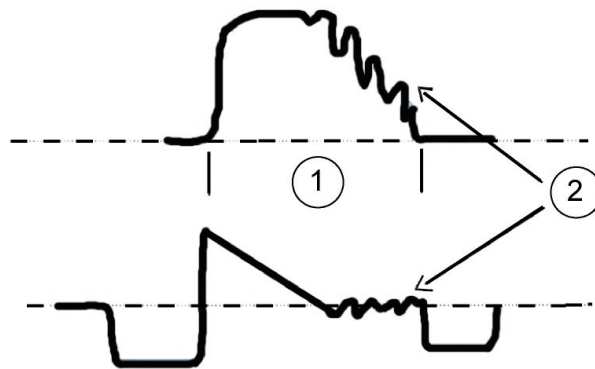

1. Expiration
2. Cardiogenic oscillations

Cardiogenic oscillations appear when:

- A continuous fresh gas flow is fed into the patient Y-piece.
- Sidestream gas sampling is done at the Y-piece.
- The patient is ventilated with a long expiration time or low respiration times, and when there is a long zero flow at end-expiration for some other reason.

Oscillations can be eliminated by adding a spacer with a 5 ml dead space between the Y-piece and the airway adapter. Increased dead space creates a buffer volume between the Y-piece and the sampling point, preventing the inspiratory and expiratory air from mixing during gas sampling. Misinterpretation of EtCO₂ information can be avoided through identifying cardiogenic oscillation and understanding the reasons for it.

## CO₂ measurement practicalities

### Ventilation management

Normoventilation (adequate alveolar ventilation of a patient) can be maintained by monitoring the end-tidal carbon dioxide and oxygen concentrations, and adequacy of ventilation can be maintained by monitoring airway pressures, volumes and spirometry loops. Alveolar minute ventilation is usually adjusted to achieve normocapnia, where EtCO₂ is in the range of 4.5% to 5.5% (34 mmHg to 41 mmHg). This is called normoventilation as it is the normal situation in healthy people.

A low EtCO₂ concentration (EtCO₂ < 4% / 30 mmHg) indicates hyperventilation.

#### NOTE

A low EtCO₂ value in itself is dependent from the ventilation volume vs. circulation status (lung perfusion). This means that in case of low blood pressure (e.g. shock) or shunting low EtCO₂ values may be observed while using a "normal" TV/MV.

Increased EtCO₂ concentration (EtCO₂ > 6.0% / 45 mmHg) indicates hypoventilation or ineffective alveolar ventilation, which will lead to hypercapnia and respiratory acidosis. Increased inspiratory CO₂ (FiCO₂) concentrations may also be caused by:

- Exhausted CO₂ absorber.
- Malfunction of the breathing system valves.

- Rebreathing when a rebreathing system without a CO₂ absorber is used with inadequate fresh gas flows.

**NOTE** During some surgical procedures, e.g. laparoscopy, CO₂ may be used to inflate the abdomen which may result in rise of PaCO₂ due to the absorption of CO₂ into the blood via the vascular wound bed. This may lead to an increase in the EtCO₂.

## Prevention of the breathing system contamination

You can use a microbial filter between the endotracheal tube and the airway adapter. Change the filter for every patient. Change the patient circuit at intervals given in the circuit manufacturer's documentation, and according to your hospital protocols.

## How to prevent effects of humidity

During low flow anesthesia, more rebreathed gas circulates through the CO₂ absorber. More humidity and heat enter the circuit from the CO₂ absorber and from the air exhaled by the patient. Also, mechanical ventilation with active humidification system used in intensive care increases the humidity in the breathing system. Water traps placed in the inspiratory and expiratory limbs of the breathing system are useful for collecting condensed water from the breathing system during long-lasting anesthesia or mechanical ventilation with active humidification system.

## AquaKnot with the Dual CO₂

- Always use the Aqua-Knot water trap with the Dual CO₂ module. The water trap holds 7 cc of water.
- The arrow on the Aqua-Knot shows the direction of the gas flow. When inserting the water trap, the arrow should point toward the module.
- Routine replacement of Aqua-Knot is not required.

## CAPNOSTAT Mainstream and Dual CO₂ sensor placement

Always position the sensor with adapter in an upright position to avoid collection of fluids on the windows of the adapter. Large concentrations of fluids at this point will obstruct gas analysis.

## CO₂ troubleshooting

Problem	Solution
Calibration fails.	<ul style="list-style-type: none"> <li>• Make sure you calibrate in a stable condition.</li> <li>• Check that the module is properly connected.</li> </ul>
CO ₂ waveform seems abnormal.	<ul style="list-style-type: none"> <li>• Check the sample lines, water trap, and airway adapters. Replace if necessary.</li> </ul>
Elevated baseline.	<ul style="list-style-type: none"> <li>• Check the patient status.</li> <li>• Check the sensor.</li> <li>• Make sure the patient is not breathing CO₂. Check that the amount of fresh gas is sufficient for the patient, and check that the CO₂ absorber is in good condition.</li> </ul>

Problem	Solution
Excessive secretions in sample lines.	<ul style="list-style-type: none"> <li>• Replace the sample lines and airway adapters.</li> </ul>
Measurement is not working.	<p>If the sensor with adapter (CAPNOSTAT Mainstream, Dual CO₂) is not positioned upright, large concentrations of fluids on the windows of the adapter will obstruct gas analysis.</p> <ul style="list-style-type: none"> <li>• Check the sensor and adapter positioning.</li> </ul>
Module does not work.	<ul style="list-style-type: none"> <li>• Contact authorized service personnel.</li> </ul>
Readings seem inaccurate.	<ul style="list-style-type: none"> <li>• Check that the gas exhaust line is not kinked or blocked.</li> <li>• Check the breathing circuit for possible leaks.</li> <li>• Check that the Aqua-Knot water trap in Dual CO₂ is not occluded.</li> </ul>
Why can we see dips in the capnogram during expiration?	<p>The dips seen in the capnogram during expiration are related to the sidestream gas sampling, the continuous gas flow to the Y-piece, and patient's cardiac contractions, which cause intra-thoracic pressure changes and therefore flow variations.</p>
Why is the EtCO ₂ value considerably lower than the CO ₂ partial pressure determined by blood gas analysis?	<p>The major clinical reasons are dead-space ventilation, ventilation/perfusion mismatch, a drop in cardiac output, alveolar shunts, and incomplete emptying of the alveoli.</p> <ul style="list-style-type: none"> <li>• Also check the integrity of the breathing circuit; blood-gas analysis corrected to a lower temperature in case of hypothermia.</li> </ul>



# Patient Spirometry

## Patient Spirometry compatibility

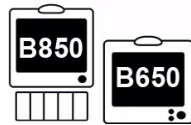

All features of this measurement are available for both monitors.

For detailed information regarding module, monitor, and accessory compatibility, see the supplemental information manual.

## Patient Spirometry safety precautions

### Patient Spirometry warnings

- |                |                                                                                                                                  |
|----------------|----------------------------------------------------------------------------------------------------------------------------------|
| <b>WARNING</b> | The presence of Helium or Xenon in the breathing circuit causes incorrect measurement values.                                    |
| <b>WARNING</b> | Make sure you select the correct sensor type for the patient: D-lite(+) for adult patients, Pedi-lite(+) for pediatric patients. |
| <b>WARNING</b> | Always check the sensor type selection from the monitor ( <b>Sensor Type</b> > <b>Adult</b> or <b>Pediatric</b> ).               |

### Patient Spirometry cautions

- |                |                                                                                                                                                                                                                 |
|----------------|-----------------------------------------------------------------------------------------------------------------------------------------------------------------------------------------------------------------|
| <b>CAUTION</b> | Never connect the loose end of the gas sampling line to the Patient Spirometry connector as this may break the spirometry unit. The Patient Spirometry connector is meant for the Patient Spirometry tube only. |
| <b>CAUTION</b> | Do not apply pressurized air or gas to any outlet or tubing connected to the monitor. Pressure may destroy sensitive elements.                                                                                  |

## Patient Spirometry limitations

- With the NICU software package, some spirometry parameters are available through the Unity Network ID connectivity device.
- E-modules can be used within their specified performance range with OR, PACU, ICU, and ED software packages.

## Patient Spirometry points to note

- Place an HME/HMEF/filter between the D-lite(+)/Pedi-lite(+) sensor and the patient.
- Disconnect the HME/HMEF/filter and D-lite(+)/Pedi-lite(+) during nebulization of medications.
- The flow measurement should be calibrated once a year or when there is a permanent difference between inspiratory and expiratory volume. For further information, see the technical manual.
- Using a cuffless intubation tube may affect Patient Spirometry readings due to potential leakages around the endotracheal tube.
- When anesthetic agents are used, use a module with anesthetic agent identification option: E-sCAiOV, E-CAiOV, or E-CAiOVX.

## Patient Spirometry measurement setup

### Patient Spirometry equipment to patient connection

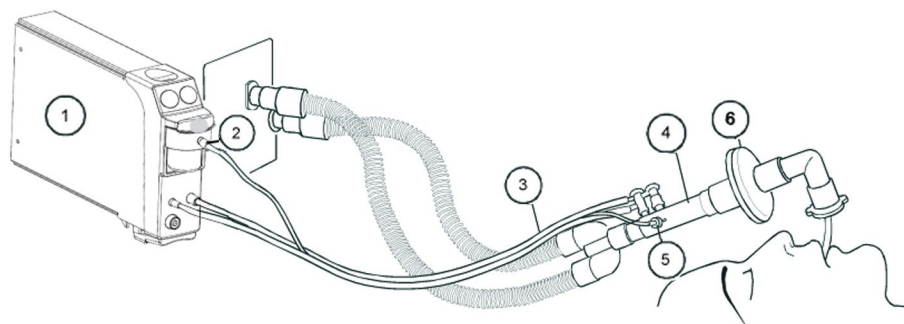

1. E-sCOV or E-sCAiOV module. You can also use the compact airway modules E-COV, E-COVX, E-CAiOV, or E-CAiOVX
2. Gas sample, gas sampling line connector on the water trap
3. Gas sampling and spirometry tubes
4. D-lite/Pedi-lite sensor, or D-lite+/Pedi-lite+ sensor for humid conditions
5. Gas sampling line
6. Heat and moisture exchanger with filter (HMEF) (optional)

### Patient Spirometry module keys

There are two keys on the CARESCAPE respiratory modules E-sCAiOV and E-sCOV:

<b>Save Loop</b>	Saves the currently active loop with corresponding numeric data.
<b>Change Loop</b>	Toggles between a Paw-Vol and a Flow-Vol loop.

There are three keys on the compact airway modules E-CAiOV, E-CAiOVX, E-COV, E-COVX:



<b>Save Loop</b>	Saves the currently active loop with corresponding numeric data.
<b>Print Loop</b>	Prints the current pressure-volume (Paw-Vol) or flow-volume (Flow-Vol) loop with corresponding numeric data.
<b>Change Loop</b>	Toggles between a Paw-Vol and a Flow-Vol loop.

## Preparing the Patient Spirometry measurement

1. Take a new Patient Spirometry tube and connect the tube to the D-lite(+)/Pedi-lite(+) sensor by inserting the angle connectors in the sensor connectors. Place all D-lite(+)/Pedi-lite(+) ports upwards with approximately a 45 °C tilt to prevent condensed water from entering the sensor interior and the tubings.
2. Connect the other end of the Patient Spirometry tube to the pressure connectors on the module.
3. Connect a gas sampling line to the Luer connector on the other side of the D-lite(+)/Pedi-lite(+) sensor.
4. Connect the other end of the gas sampling line to the sampling line connector on the module's water trap.
5. Make sure that the connections are tight.
6. Select the correct sensor type.
7. Connect the D-lite(+)/Pedi-lite(+) between the Y-piece and the intubation tube in the breathing circuit.

## Checking the Patient Spirometry measurement

1. Check that the water trap is empty.
2. Occlude the sampling line and check that the **Sample line blocked** message appears within 30 seconds and gas waveforms are showing zero at the same time.
3. Check that the loops are whole. A gap between the starting and ending points may indicate a leak.

## Using the Patient Spirometry measurement

### Selecting the Patient Spirometry sensor type

When monitoring pediatric patients with tidal volumes of 15 ml to 300 ml, use the Pedi-lite/Pedi-lite+ sensor. For other patients, use the D-lite/D-lite+ sensor. Select the sensor type accordingly.

1. Select the Patient Spirometry parameter window.
2. Select **Setup**.
3. Select the sensor type (**Pediatric** or **Adult**) from the **Sensor Type** list.

### Selecting the Patient Spirometry scaling type

This setting affects pressure (**Paw**) and flow waveform scales, and pressure-volume (**Paw-Vol**) and flow-volume (**Flow-Vol**) loop scales.

Note that the **Flow** waveform can also be drawn as a mirror image according to what has been selected in the **Care Unit Settings > Parameters > Inspiratory Flow**. This selection is password protected.

**Auto** scaling adjusts the scales automatically. With **Vol** scaling type all scales will change when you change one. With **Independent**, you can change each scale separately.

1. Select the Patient Spirometry parameter window.
2. Select **Setup**.
3. Select an option from the **Scaling** list.

## Selecting the Patient Spirometry scaling speed

This option is available with automatic scaling only. It determines how frequently the scales are changed. **Fast** reacts quickly if current scales are not optimal. The minimum time between scale changes is 2 seconds with **Fast** and 20 seconds with **Slow**.

1. Select the Patient Spirometry parameter window.
2. Select **Setup**.
3. Select an option from the **Scaling Speed** list.

## Selecting the Patient Spirometry scales

You can change the **Vol Scale ml**, **Paw Scale**, and **Flow Scale l/min** unless the automatic scaling is in use. Changing Spirometry scales affects **Paw** and **Flow** waveform scales, and **Paw-Vol** and **Flow-Vol** loop scales. With **Vol** scaling type in use all scales will change when you change one. With **Independent** scaling type you can change each scale separately.

1. Select the Patient Spirometry parameter window.
2. Select **Setup**.
3. Select suitable options from the lists **Vol Scale ml**, **Paw Scale**, or **Flow Scale l/min**.

## Selecting the Patient Spirometry sweep speeds

This setting affects the sweep speed of **Flow** and **Paw** waveforms. It does not affect the loops.

1. Select the Patient Spirometry parameter window.
2. Select **Setup**.
3. Select suitable options from the **Paw Sweep Speed** or **Flow Sweep Speed** list.

The smaller the value, the slower the sweep speed.

## Selecting the displayed Patient Spirometry volume type

This setting determines which numeric data (tidal volumes **TVinsp** and **TVexp**, or minute volumes **MVinsp** and **MVexp**) will appear in the **Flow** parameter window.

**NOTE** In OR and PACU software packages, this setting also affects the **Spiro 1** split screen accordingly.

1. Select the Patient Spirometry parameter window.

2. Select **Setup**.
3. Select an option from the **Show Volume** list.

## Changing the Patient Spirometry loop type

To change the displayed loop from a **Paw-Vol** loop to a **Flow-Vol** loop or vice versa, press the **Change Loop** module key, or:

1. Select the Patient Spirometry parameter window.
2. Select **Loops**.
3. Select **Paw-Vol Loop** or **Flow-Vol Loop**.

### NOTE

In OR and PACU software packages, the loop view shows **Ppeak, Pplat, Pmean** and **PEEPtot** numbers. In other software packages, the loop view shows **Ppeak, Pplat, Pmean, PEEPe** and **PEEPi** numbers.

## Saving Patient Spirometry reference loops

Save a loop for reference of the current lung mechanics, and whenever major changes in the patient's status occur. Press the **Save Loop** module key, or:

1. Select the Patient Spirometry parameter window.
2. Select **Loops > Save Loop**.

The monitor automatically displays the first saved loop as a reference loop. You can save up to six pairs of loops. If you save another pair of loops after the sixth one, the second oldest reference loop is automatically erased.

## Selecting a Patient Spirometry reference loop

You can select a saved loop to the screen for reference.

1. Select the Patient Spirometry parameter window.
2. Select **Loops**.
3. Select a loop from the **Reference Loop** list.

## Erasing a Patient Spirometry reference loop

You can erase unnecessary reference loops.

1. Select the Patient Spirometry parameter window.
2. Select **Loops**.
3. Erase the loop by selecting **Erase Selected**.

## Printing a Patient Spirometry loop

You can print the currently displayed loop.

1. Select the Patient Spirometry parameter window.
2. Select **Loops**.
3. Select **Print Loop**.

**NOTE** With compact airway modules, you can also print the loop by pressing the **Print Loop** module key.

## Setting Paw alarm limits

You can set the limit alarms on or off, and adjust their activation limits according to your needs.

1. Select the Patient Spirometry parameter window.
2. Select **Paw Alarms**.
3. Set the alarm limits: PEEPtot (OR and PACU software packages), PEEPi and PEEPe (other software packages), Ppeak and MVexp.

**NOTE** If the feature is not active, the alarm limits are greyed out. Select **Alarm On** to set the alarms.

## Setting MV/Vent alarm limits

You can set the limit alarms on or off, and adjust their activation limits according to your needs.

1. Select the Patient Spirometry parameter window.
2. Select **MV/Vent Alarms**.
3. Set the alarm limits.

**NOTE** If the feature is not active, the alarm limits are greyed out. Select **Alarm On** to set the alarms.

**NOTE** **MV/Vent Alarms** cannot be selected off except when an interfaced device is used.

**NOTE** To enable apnea and technical alarms from the ventilator, select the **Ventilator Apnea and Technical Alarms** check box.

# Patient Spirometry measurement basics

## Patient Spirometry measurement description

The CARESCAPE respiratory modules E-sCOV and E-sCAiOV, and the compact airway modules E-COV, E-COVX, E-CAiOV, and E-CAiOVX measure airway pressures, flow, volumes, compliance and airway resistance breath by breath at the patient's airway. All parameters are measured through D-lite(+)/Pedi-lite(+) flow sensor placed at the patient's airway.

## D-lite(+)/Pedi-lite(+) flow sensor

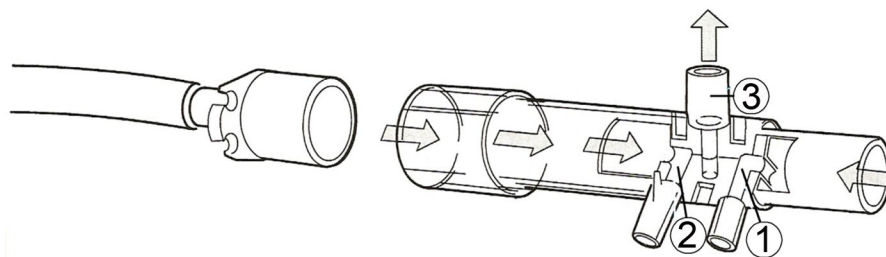

1. For total pressure measurement
2. For static pressure measurement
3. For gas samples

The velocity of gas flow is obtained when the dynamic pressure is measured by the two hollow tubes (1 and 2). On inspiration, gas moves from the anesthesia machine or ventilator to the patient by point 1 which measures the total pressure, and at the same time the pressure at tube 2 is measured as the static pressure. The static pressure at 2 is subtracted from the total pressure at 1 to give the dynamic pressure. Dynamic pressure is proportional to the velocity of gas flow. D-lite(+)/Pedi-lite(+) is designed to work in both directions; during expiration the process is reversed. Gas samples for CO₂, O₂, N₂O and anesthetic agent measurements are taken through port 3.

One end of the sensor has a 15 mm male connector for a Y-piece connection, while the patient end consists of a 22 mm male connector for the ventilation mask and a concentric 15 mm female connector for the endotracheal tube. A disposable double-lumen tube conducts the flow signal as a pressure difference to the pressure sensor inside the monitor. This measurement method means that there is no gas flow in the double-lumen tube, but only pressure pick-up. A respiratory gas sampling line connected to the D-lite(+)/Pedi-lite(+) completes the monitoring system. Gas sampling is important to enable compensation of the effect of different gas viscosities on tidal and minute volume calculations.

## Patient Spirometry parameters

Measured Patient Spirometry parameters are the following:

- Inspiratory and expiratory tidal volumes (TV_{insp/exp})
- Inspiratory and expiratory minute volumes (MV_{insp/exp})
- Airway pressures
- Peak pressure (P_{peak}): maximum pressure during one breath
- Plateau pressure (P_{plat}): pressure at the reversal point of the flow
- Mean pressure (P_{mean}): average pressure during one breath
- Real-time pressure waveform (P_{aw})
- Positive end expiratory pressure (PEEP_{tot}) in OR and PACU software packages only: the pressure in the lungs at the end of expiration, measured when expiratory phase changes to inspiratory flow.
- Extrinsic positive end expiratory pressure (PEEP_e) and intrinsic positive end expiratory pressure (PEEP_i) (not in OR and PACU software packages).
- Compliance (CompI): calculated for each breath, indicates the pressure difference required to deliver a certain volume of gas into the patient.

**NOTE** Not measured with spontaneous breaths.

- Airway resistance (Raw): calculated from an equation describing the kinetics of gas flow between the lungs and a flow sensor.

**NOTE** Not measured with spontaneous breaths.

- Real time waveform (Flow)
- Ratio of the inspiratory and expiratory time (I:E)
- Pressure-volume loop (Paw-Vol. loop)
- Flow-volume loop (Flow-Vol. loop)

## Airway pressures

Airway pressure waveform on the right and pressure-volume loop on the left:

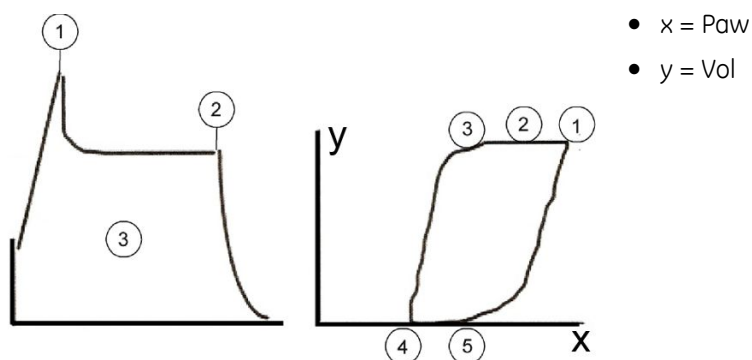

1. Ppeak
2. Pplat
3. Pmean
4. PEEPe
5. PEEPtot
6.  $(PEEPi = PEEPtot - PEEPe)$

**NOTE** PEEPe and PEEPi not available in OR and PACU software packages.

## PEEPtot

**NOTE**

The following loop illustrates how PEEPtot (=PEEPe + PEEPi) is displayed.

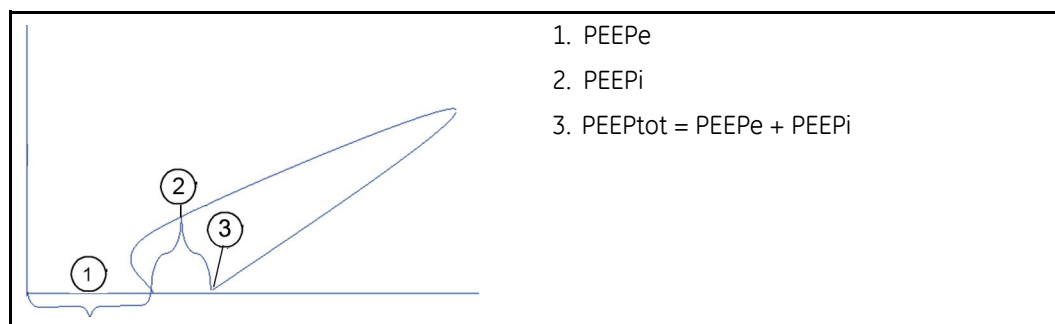

## PEEPi

**NOTE** Not available in OR and PACU software packages.

High respiration rate or short expiratory time may lead to the development of intrinsic PEEP. It is detected when alveolar pressure at the end of the expiration is higher than airway opening pressure. PEEPi is likely to occur in patients with airflow obstruction, inverse ratio ventilation or patients with flow limitation.

Dynamic PEEPi is measured continuously and displayed as a digit, but it is also presented graphically in the flow waveform and in loops:

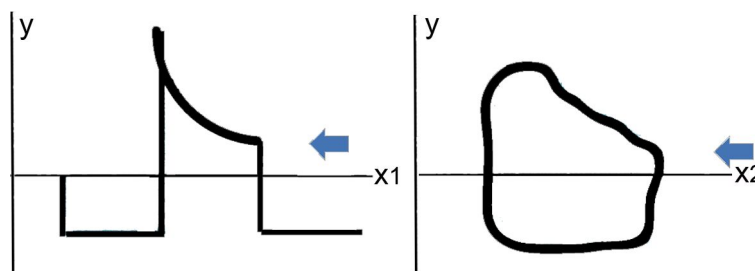

x1 = Time

x2 = Vol

y = Flow

The clinical significance of PEEPi is in detecting both the respiratory and hemodynamic side effects:

- Respiratory side effects
  - Barotraumas
  - Muscle fatigue
  - Decreased compliance
  - Reduced oxygen delivery
  - Increased ventilatory dead space
- Hemodynamic side effects:
  - Impeded venous return
  - Increased pulmonary vascular resistance
  - Reduced left ventricular compliance

## Static PEEPi measurement

In static PEEPi measurement, an end-expiratory pause (occlusion maneuver) of at least four seconds is produced at the ventilator. When the airway is occluded at the end-expiration, and if the patient is hyperinflated, alveolar pressures will equilibrate with the airway pressure measured in D-lite(+)/Pedi-lite(+), which will rise until a plateau is reached, corresponding to total PEEP or PEEPi, if set PEEP is 0.

**NOTE** If both the dynamic and static PEEPi are measured, the dynamic values are usually slightly lower.

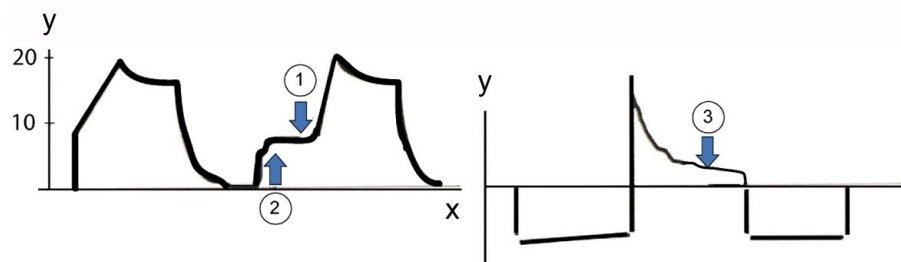

- x = Time
- y = Paw
- 1. PEEPtot
- 2. End-expiratory pressure hold
- 3. Expiratory flow

## I:E ratio

I:E ratio is an expression of the relationship of inspiration time to expiration time. A typical value 0.5 means that the expiration time is twice the inspiration time. The following examples illustrate the difference between I:E durations of 1:2 and 1:3.

If respiration rate is 10 breaths/min (respiration cycle 6 seconds) and I:E is 1:2, then the inspiration time is 2.0 seconds and the expiration time is 4.0 seconds:

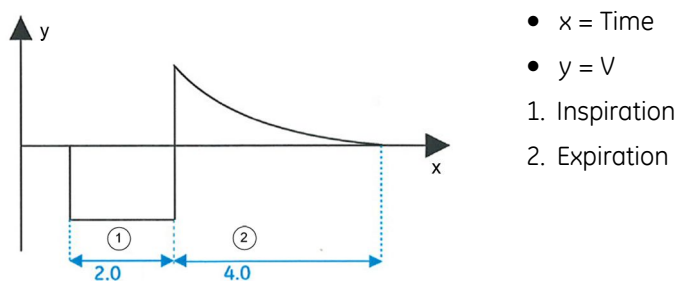

- x = Time
- y = V
- 1. Inspiration
- 2. Expiration

If respiration rate is 10 breaths/min (respiration cycle 6 seconds) and I:E is 1:3, then the inspiration time is 1.5 seconds and the expiration time is 4.5 seconds:



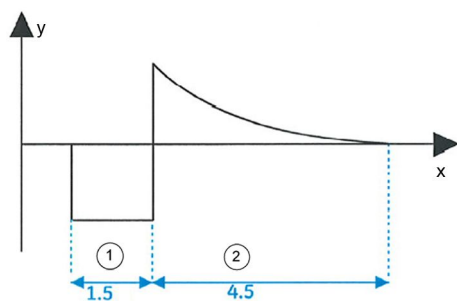

- $x = \text{Time}$
  - $y = \dot{V}$
1. Inspiration
  2. Expiration

## Compliance

The measurement of pressure and volume allows for the calculation of the lungs' dynamic compliance - in other words, how well an additional volume enters the lungs when pressure is exerted on the airway. Compliance describes the extensibility of the lung-thoracic system but is dominated by alveolar (that is, purely peripheral) properties.

Typical compliance for adults varies between 35 ml/cmH₂O and 60 ml/cmH₂O, and typical compliance for children is more than 15 ml/cmH₂O.

Decrease in compliance may indicate too high a PEEP level, acute lung injury, or increased intra-abdominal pressure (bleeding, ascites). Decreased compliance indicates a worsening ventilatory status.

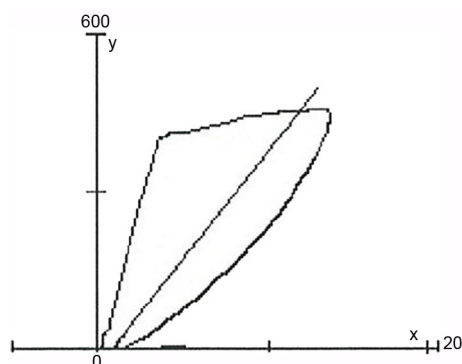

Typical compliance

- $x = P_{aw}$
- $y = \text{Vol}$

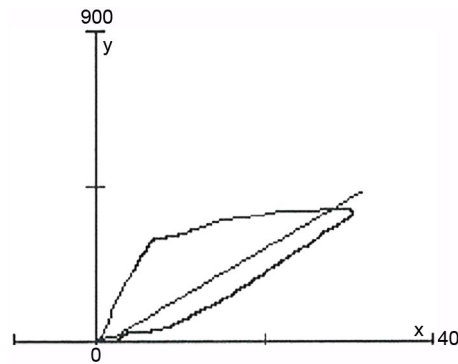

Low compliance

- $x = P_{aw}$
- $y = \text{Vol}$

## Airway resistance (Raw)

Airway resistance expresses the relationship between the pressure difference across the airway (between the mouth and the alveoli) and the rate at which gas is flowing through the airway. An increasing airway resistance usually indicates an airway obstruction and may lead to barotrauma. In critically ill patients, factors causing increased airway resistance should be identified as quickly as possible to avoid lung overdistension or decreased oxygen delivery.

### NOTE

An endotracheal tube greatly contributes to Raw. The resistance of the tube is normally higher than that of the remaining internal airways.

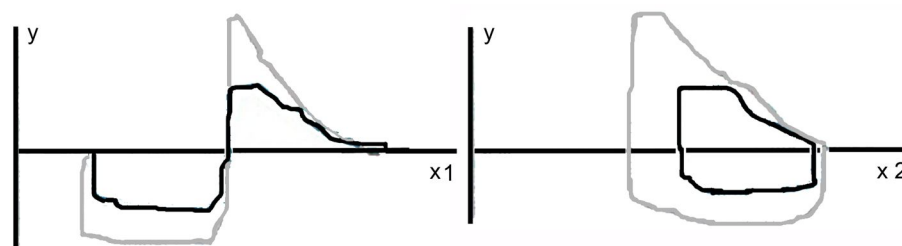

- x 1 = Time
- x 2 = Vol
- y = Flow

## Patient Spirometry loops and waveforms

Graphical flow and pressure waveforms and pressure-volume (Paw-Vol) and flow-volume (Flow-Vol) loops enable immediate detection of changes in the patient's ventilatory status.

The Paw-Vol loop illustrates the dynamic relationship between pressure and volume. The Flow-Vol loop indicates the relationship between flow and volume.

### Paw-Vol phases

- x1 = Paw cmH₂O
- y1 = Vol ml
- x2 = Time
- y2 = Paw

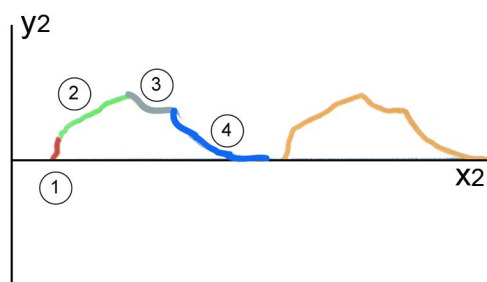
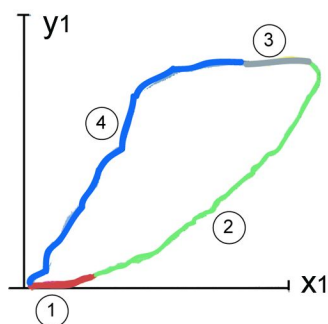

1. Start of inspiration
2. Inspiration
3. Pause
4. Expiration

### Normal Paw-Vol loop

The shape of the Paw-Vol loop depends on the patient's respiratory status and the ventilation mode used. The "normal" Paw-Vol loop appears if only a small pressure is required before volume starts entering the lungs.

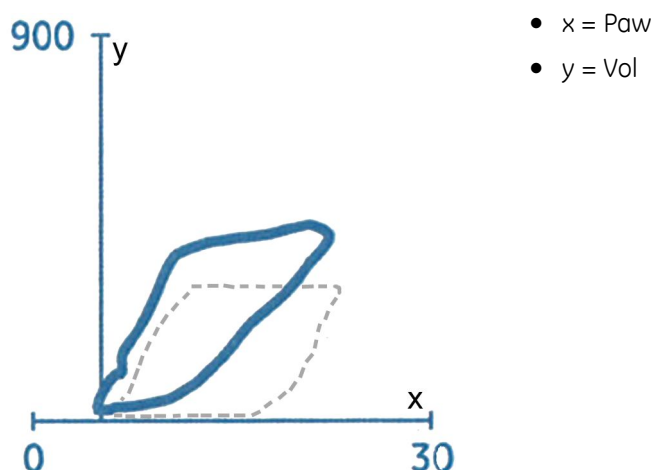

### Typical pediatric Paw-Vol loop

In pediatric use, the scales for pressure and volume are different from those of the adult use. Pediatric patients have relatively high airway pressures due to the very small endotracheal tube. Using a proportionally higher scale for pressure than for volume makes it possible to draw pediatric loops with a shape that is similar to that of adult loops.

Typically:

- High airway pressure (small diameter of the tube)
- Low compliance
- Insp > Exp (leak around tube) - loop remains open

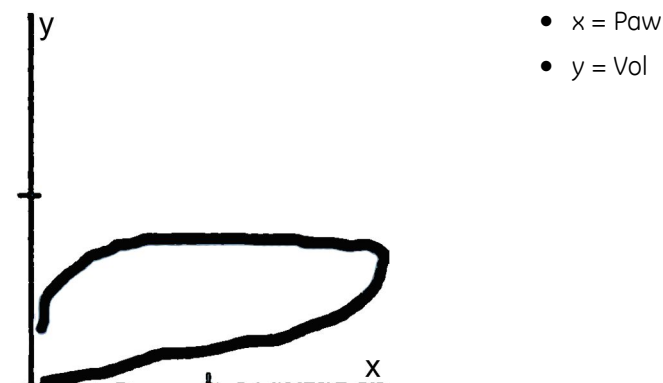

### Flow-Vol phases

Flow-Vol loop illustrates the relationship between flow and volume. Inspiratory flow shows the type of flow pattern used by the ventilator, and expiratory flow indicates the resistance during expiration. All flow-restrictive incidents (airway obstruction, intrinsic PEEP) are visible in the Flow-Vol loop.

- $x_1 = \text{Vol}$
- $x_2 = \text{Time}$
- $y = \text{Flow}$

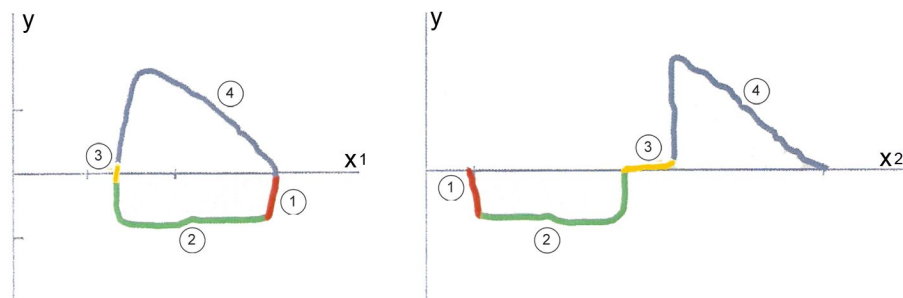

1. Start of inspiration
2. Inspiration
3. Pause
4. Expiration

## Normal Flow-Vol loop

When using volume-controlled, constant-flow ventilation mode, normal Flow-Vol loop reflects correct functioning of the ventilator and no airflow limitations of the patient.

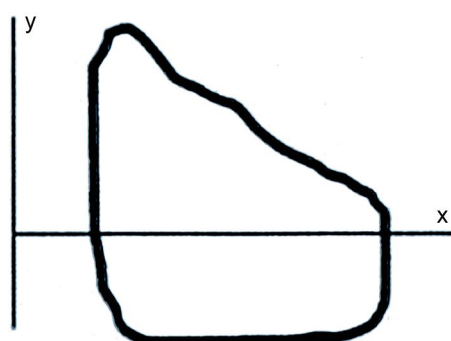

- $x = \text{Vol}$
- $y = \text{Flow}$

## Patient Spirometry practicalities

- Correct placement of the Patient Spirometry accessories is essential for accurate and trouble-free operation of the measurement.
- The D-lite(+)/Pedi-lite(+) sensor is placed close to the patient's airway; remember to use D-lite(+) for patients whose tidal volume is 15 ml to 2000 ml, and Pedi-lite(+) for patients whose tidal volume is 15 ml to 300 ml. Remember to select the correct sensor type.
- Humidity condensing in the Patient Spirometry ports of the D-lite(+)/Pedi-lite(+) sensor may increase the measured volumes during longer low flow anesthesia. Position the sensor in such a way that gravity can remove the condensed water from the Patient Spirometry tubes.

## Patient Spirometry troubleshooting

Problem	Solution
Values seem erroneous	<ul style="list-style-type: none"> <li>• Check the patient status.</li> <li>• Check that you are using the correct sensor type: D-lite(+) for adult patients, Pedi-lite(+) for pediatric patients.</li> <li>• Check the sensor type selection.</li> <li>• Check that the Patient Spirometry tube connectors and their connections are tight and not leaking.</li> <li>• Check the arterial blood gas values.</li> <li>• Check that the sampling line is not kinked.</li> </ul>
Values seem unstable	<ul style="list-style-type: none"> <li>• Remove the D-lite(+)/Pedi-lite(+) and shake drops away.</li> <li>• Check that the connectors on the D-lite(+)/Pedi-lite(+) are intact and that connections are tight.</li> </ul>
Strong vibrations in the loop	<ul style="list-style-type: none"> <li>• Check the patient status.</li> <li>• Check the patient and system for water or secretions.</li> </ul>
Why do the monitor and the ventilator show a different compliance value?	The monitor measures directly at the endotracheal tube and reflects more accurate compliance of the lung. Hoses and other equipment between the patient and the ventilator influence the values measured in the ventilator.



# 19

## Gas exchange

### Gas exchange compatibility limitations

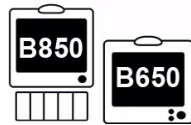

All features of this measurement are available for both monitors.

For detailed information regarding module, monitor, and accessory compatibility, see the supplemental information manual.

### Gas exchange safety precautions

#### Gas exchange warnings

Before using the gas exchange measurement, familiarize yourself with safety precautions related to airway gases and Patient Spirometry measurements.

- WARNING** The presence of Helium or Xenon in the breathing circuit causes incorrect measurement values.
- WARNING** Make sure you select the correct sensor type for the patient: D-lite(+) for adult patients, Pedi-lite(+) for pediatric patients.
- WARNING** Always check the sensor type selection from the monitor (**Sensor Type** > **Adult** or **Pediatric**).
- WARNING** If the expiration gas flow during the end phase of the patient's expiration is close to zero for more than two seconds before the next inspiration starts, the ventilator's bypass flow may affect the measurement.

**WARNING** Measurement results are valid only when the respiration rate is <35/ minute due to non-adequate time for accurate sampling.

VO₂/VCO₂ values cannot be measured correctly:

- With a leaking airway
- With FiO₂ >85%
- If N₂O is used in ventilation
- If the delivered FiO₂ level is fluctuating during inspiration
- If Helium or Xenon are used in ventilation

Measurements cannot be taken during the following ventilation modes due to non-adequate time for accurate sampling:

- High by-pass flow
- High frequency ventilation (HFV)
- Bi-level positive airway pressure (BiPAP)

## Gas exchange cautions

**CAUTION** Never connect the loose end of the gas sampling line to the Patient Spirometry connector as this may break the spirometry unit. The Patient Spirometry connector is meant for the Patient Spirometry tube only.

**CAUTION** Do not apply pressurized air or gas to any outlet or tubing connected to the monitor. Pressure may destroy sensitive elements.

## Gas exchange measurement limitations

- This measurement is not available in the NICU software package.
- E-modules can be used within their specified performance range with OR, PACU, ICU, and ED software packages.
- Only the E-CAiOVX and E-COVX modules measure gas exchange.

**NOTE** Routine calibration checks are required to ensure the measurement accuracy.

## Gas exchange points to note

- Gas exchange measurement is for intubated patients only.
- Use only 2-meter (7-ft) gas sampling lines. Using other lines may cause inaccurate readings.
- FiO₂ delivery from the ventilator side should be stable.
- High PEEP or ventilating pressures may activate a message prompting to check the water trap. In this case, you may consider decreasing the PEEP if possible.
- To ensure measurement accuracy, check the accuracy of airway gas measurement once a month: feed calibration gas mixture to the monitor in the normal operation mode (without entering the calibration menu) and check that the readings on the



monitor match those on the calibration gas bottle. If they do not match, calibrate airway gases.

- When anesthetic agents are present, use the E-CAiOVX module for monitoring airway flow, gas exchange, and metabolism.

## Gas exchange measurement setup

### Gas exchange equipment to patient connection

The equipment to patient connections for gas exchange are similar to those of Patient Spirometry but there are also some connection-related issues to be noted. Only the modules E-CAiOVX and E-COVX measure gas exchange.

#### Gas exchange patient connections with HME/HMEF/filter

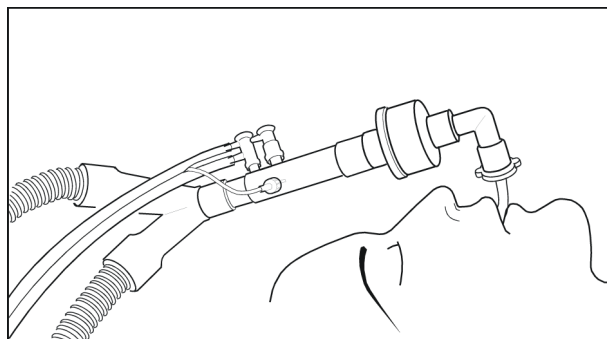

**NOTE** Always place the HME/HMEF/filter between the D-lite(+) sensor and the patient.

**NOTE** By-pass flow together with long expiration flow pause time may disturb the measurement. Consider using shorter expiration time to diminish the effect. In addition, you may use a suitable spacer with a 5 to 10 ml dead space (e.g., a straight T-adapter) between the Y-piece and D-lite(+)/Pedi-lite(+). The by-pass flow effect may exist even in an adult setting, but it is more emphasized when monitoring pediatric patients and using the Pedi-lite(+).

#### Gas exchange patient connections with flexible tube

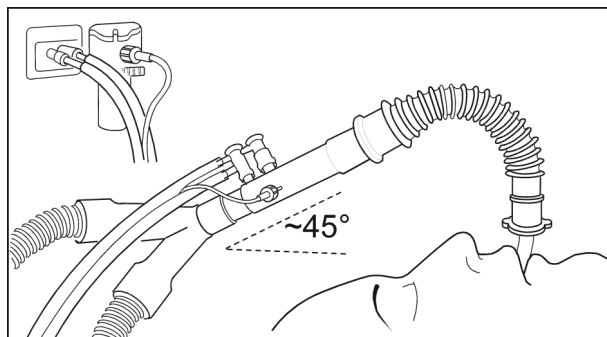

**NOTE** Place all D-lite ports upwards with a 20° to 45° tilt to prevent condensed water from entering the sensor interior and the tubings.

**NOTE** When monitoring pediatric patients with tidal volumes of 15 to 300 ml, use the Pedi-lite(+) sensor. Remember to select the sensor type accordingly.

## Checking the gas exchange measurement

1. Check that the water trap is empty.
2. Occlude the sampling line and check that the **Sample line blocked** message appears within 30 seconds and gas waveforms are showing zero at the same time.

## Using the gas exchange measurement

### Selecting the gas exchange sensor type

Select the sensor type (**Adult** or **Pedi**) according to the sensor you are using.

1. Select the gas exchange parameter window.
2. Select the **Setup** tab.
3. Select the sensor type from the **Sensor Type** list.

### Selecting EE and RQ averaging time

Averaged values of energy expenditure (EE) and respiratory quotient (RQ) update every minute. The bar in the EE+RQ parameter window indicates with green color the amount of data that the monitor uses for performing the average calculations.

When a patient is admitted/a case is started, no averaged value is displayed until 10 minutes of valid EE and RQ data is available. After that, the EE and RQ values are gray until there is enough (> 1/5 of the selected averaging time) data to perform reliable calculations.

1. Select the gas exchange parameter window.
2. Select the **Setup** tab.
3. Select a value from the **EE Average Time** list.

**NOTE** The values in the parameter window turn gray whenever there is not enough valid EE and RQ averaging data.

**NOTE** If the RQ is out of the physiological range (<0.6 or >1.3), the monitor does not store the EE and RQ values in the trend history or use them for average calculations.

## Weighted VO₂ and VCO₂

To have weighted values for VO₂ (**VO2/kg** or **VO2/m2**) and VCO₂ (**VCO2/kg** or **VCO2/m2**), you must enter the patient's height and weight. For **VO2/kg** and **VCO2/kg**, measured values are divided by the patient's weight, and for **VO2/m2** and **VCO2/m2**, measured values are divided by the patient's BSA.

## Stopping the gas exchange measurement

1. Remove the gas exchange parameter windows from the screen.

You can continue measuring airway gases and Patient Spirometry with the same module.

## Gas exchange measurement basics

### Gas exchange measurement description

The E-COVX and E-CAiOVX modules with gas exchange option enable monitoring of O₂ consumption (VO₂), CO₂ production (VCO₂), energy expenditure (EE) and respiratory quotient (RQ).

To provide an accurate breath-to-breath measurement of respiratory gas exchange, the E-COVX and E-CAiOVX modules algorithmically integrate sidestream gas concentrations (CO₂ and O₂) as well as flows and volumes generated by each breath. This is done with the D-lite(+)/Pedi-lite(+) flow sensor in conjunction with the fast paramagnetic oxygen sensor and the infrared gas bench for CO₂ measurement. Due to the sidestream measurement principle, there is a delay of approximately 2.5 seconds in the measurement, caused by the traveling time of the sample through the sampling line to the module. The module algorithmically synchronizes these concentrations and flows.

To obtain the oxygen consumption of a patient, the gas exchange module measures the amount of oxygen that is inhaled, and subtracts the exhaled amount from it. Carbon dioxide production is measured by subtracting the amount of inhaled carbon dioxide from the amount of exhaled. These amounts can be obtained by multiplying each measured volume sample by the corresponding gas concentration.

To ensure volume measurement results that are less sensitive to errors, the Haldane transformation is applied. The Haldane transformation is based on the assumption that nitrogen is an inert gas, and an individual will neither consume nor produce it, except in the case of air emboli. Therefore, the amount of nitrogen inhaled is equal to the amount exhaled.

### How to interpret the gas exchange values

Though the measurements can be made easily, accuracy and reproducibility of results requires understanding of the basic principles of the measurement and related physiology. Furthermore, gas exchange, or indirect calorimetry, is sensitive to measurement errors; the need for routine procedures of quality control is therefore emphasized. Despite accurate measurement, several clinical and physiological factors influence the results of gas exchange measurements and should be considered in interpretation. In this respect, the relationship between ventilation and gas exchange is of crucial importance. Any acute change in alveolar ventilation will be immediately reflected in CO₂ production, which will not measure the metabolic production of CO₂, until a new steady state has been achieved. Similar, but shorter, transient will also be seen in O₂ consumption. Analogously, acute changes in tissue perfusion may influence both tissue oxygen uptake and removal of CO₂ from the tissues.

Pulmonary gas exchange measurement means monitoring of oxygen consumption (VO₂) and carbon dioxide production (VCO₂). Based on these measurements, it is possible to calculate the respiratory quotient, RQ, which is the ratio between CO₂

production and O₂ consumption, as well as the energy expenditure, EE, which indicates the number of calories of energy the patient is using. The measurement of pulmonary gas exchange corresponds to the release of energy from the body in a steady state. A steady state condition can be defined as a period of time after the patient has stabilized from any changes and will not incur further changes in treatment that may affect their gas exchange or increase metabolism. Whenever the homeostasis of a patient is changed, the steady state condition is disrupted, and a certain period of time has to pass before a new steady state is re-established. This should be noted in short-time measurement. In continuous measurement, obtaining average results over longer periods helps eliminating the effects of varying steady state.

### Oxygen consumption (VO₂)

Indirect calorimetry measures oxygen consumption as the uptake of oxygen from the respiratory gases. Acute changes in ventilation, hemodynamics, and physical activity may induce wide variations in the VO₂ measured by any method. Since VO₂ can be measured continuously, the transient changes in the measured VO₂ can be readily observed in prolonged measurements.

Under aerobic conditions, VO₂ depends on the metabolic activity of the tissues. At a given metabolic rate, the substrates of energy metabolism also have an impact on the VO₂, since the amount of oxygen required to produce the same amount of energy from different substrates varies. The amount of oxygen needed to produce 1 kcal of energy from carbohydrate is 207 ml, from fat 213 ml, and from protein 223 ml.

If the amount of oxygen delivered to the tissues is inadequate for metabolic needs, tissue oxygen consumption becomes dependent on oxygen delivery and anaerobic metabolism with lactic acid production will ensue. During anaerobic metabolism, the VO₂ measured from the respiratory gases does not reflect the tissue oxygen needs, since an oxygen debt develops in the tissues. When aerobic conditions are restored, the oxygen debt will be reflected as increased oxygen consumption.

### Carbon dioxide production (VCO₂)

Measurement of carbon dioxide production (VCO₂) by indirect calorimetry is susceptible to major errors unless the close relationship between VCO₂, alveolar ventilation (VA), and arterial CO₂ (PaCO₂) is taken into account. According to the classical Bohr's equation,  $VCO_2 = VA \times PaCO_2/k$ , where k is a constant that depends on the units and the conditions (pressure, temperature, humidity) of the measurement. The constant is equal to 0.1150 when:

- VCO₂ is given in ml/min, standard temperature (0°C) and dry gas (STPD),
- VA is given in l/min, 37 °C, and fully saturated with water vapor (BTPS),
- and PaCO₂ is given in kPa,

The Bohr's equation demonstrates that the measurement of VCO₂ is sensitive to changes in ventilation: any change in alveolar ventilation will be directly reflected in VCO₂ until a new steady state of PaCO₂ has been achieved.

In steady state, VCO₂ depends on the metabolic activity of the tissues and, similarly to VO₂, on the substrates of the energy metabolism. Production of 1 kcal of energy from carbohydrate produces 207 ml of CO₂, from fat it produces 151 ml, and from protein it produces 181 ml. If any of the variables in the Bohr's equation changes, the body CO₂ pool will change. Under these circumstances, enough time should be allowed for the body CO₂ pool to stabilize if the measured VCO₂ should reflect the metabolic production of CO₂. Continuous measurement of gas exchange facilitates the verification of a steady state.

## Respiratory quotient

The ratio between  $VCO_2$  and  $VO_2$  is called the respiratory quotient when measured in steady state conditions. In steady state conditions, the RQ reflects the mixture of substrates used by the energy metabolism. The RQ is 1 for carbohydrate, 0.7 for fat, and approximately 0.81 for protein. Detailed analysis of substrate oxidation requires measurement of urinary urea excretion for the assessment of protein oxidation and calculation of the non-protein RQ.

For clinical purposes, major shifts in substrate oxidation are reflected in the total RQ, as measured directly from the respiratory gases. Increased glucose oxidation may be observed as an RQ approaching 1, whereas increased fat oxidation may result in an RQ approaching 0.7.

A steady state RQ above 1 may indicate fat synthesis and is a clinical rarity, associated with excessive carbohydrate feeding. Even in these conditions, the RQ rarely exceeds 1.3. A steady state RQ below 0.7 is also a rarity, but may occur during ketosis, if the ketone bodies are incompletely oxidized and excreted into the urine. RQ values exceeding 1 or below 0.7 should be carefully examined for measurement errors and the lack of steady state. Typically the most common causes for unphysiological or erroneous RQ values are changes in ventilation: hyperventilation increases RQ, hypoventilation decreases it until a new steady state of body  $CO_2$  pool has been achieved. Analogously, the development of an oxygen debt will increase the RQ, whereas replenishment of an oxygen debt will reduce the RQ.

## Energy expenditure

The energy expenditure cannot be directly measured by indirect calorimetry, but it is calculated from the measured gas exchange variables.

Resting normal values for  $VO_2$  and  $VCO_2$  vary according to the body size, age, and sex of the patient. Rough estimates of normal values can be obtained for example by using the Harris-Benedict formula.

An increase in energy expenditure will be reflected as a proportional increase in both  $VO_2$  and  $VCO_2$ . Temporary increase of up to 200% can occur due to shivering and convulsions, for instance. Clinical conditions associated with hypermetabolism, like injury or sepsis, may increase energy expenditure by up to 50% and in extreme cases, even up to 100%.

Patients with severe pulmonary pathology and impairment of respiratory mechanics may have markedly increased work of breathing: the oxygen cost of breathing can be up to 20% of the whole body  $VO_2$ , whereas it normally represents less than 5% of the total  $VO_2$ .

Hemodynamic catastrophes, like circulatory collapse, may acutely reduce both  $VO_2$  and  $VCO_2$ , and a compensatory increase can be observed once adequate tissue perfusion has been restored.

Various factors contribute to energy expenditure:

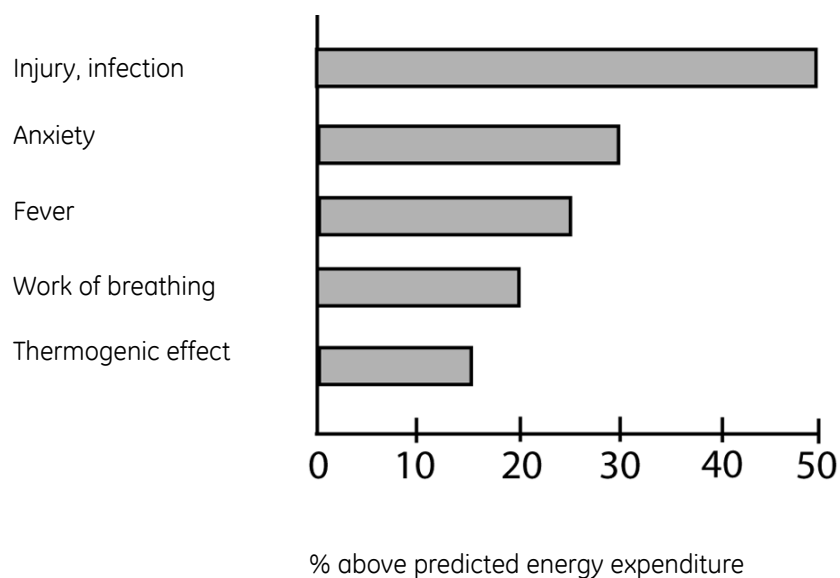

## Gas exchange practicalities

A steady state condition should be present to ensure that the gas exchange measurement is equivalent to the tissue gas exchange. In addition, different physiological factors may affect the stability of the patient: a change in the breathing pattern, lung volume, dead space or circulatory status induces an abrupt change in the inspiratory and expiratory gas concentrations. These factors also determine how fast the measurement stabilizes. The patient should be motionless and with consistent respiratory rates and volumes.

Although gas exchange can be measured over a short period of time, a period of at least 20 to 30 minutes is preferable. By prolonging the measurement period, more valid information on the average gas exchange can be obtained.

Several variables can contribute to inaccurate information. To ensure correct measurement, keep these practical considerations in mind:

- Sampling line.
  - To ensure correct module initialization, always connect the sampling line and the D-fend to the module before turning on the monitor or connecting the module to a monitor that is already on.
  - Use a correct sampling line length. Sampling lines require specific lengths and diameters for accurate reporting of gas and flow. GE recommends using only a 2-m (7-ft) sampling line.
- Free tubing with no obstructions.
  - Check that there is no water (active humidity, secretions) or kinked tubing in a line.
- Measurement calibration and accuracy.
  - To ensure measurement accuracy, check the accuracy of airway gas measurement once a month.
  - Make sure you are using correct calibration gas.
  - Ensure that the calibration gas and regulator are functioning properly before calibration. Do not wash or disinfect calibration gas sampling lines.

- Correct positioning of the sampling setup in the patient circuit.
  - Straight Y-piece (physical dead space < 8 ml).
  - If a heat and moisture exchanger (HME) or an HME with filter (HMEF) is used, place it between the D-lite(+)/Pedi-lite(+) sensor and the patient.
  - Use the D-lite+ sensor for continuous monitoring. Condensed water inside the D-lite may distort the volume readings.
  - Use a pediatric Pedi-lite or Pedi-lite+ sensor for pediatric patients (tidal volumes 15 ml to 300 ml) and remember to select the correct sensor type in the monitor menu.
- Ventilator function.
  - Check the circuit for any leaks as they may cause inaccurate volume measurement.
  - Use of by-pass flow may result in inaccurate volume measurement.
  - Max. 85% FiO₂ can be used, higher reading will increase the sensitivity of the Haldane transformation to error.

## Gas exchange troubleshooting

Problem	Solution
Gas exchange values are too low.	<ul style="list-style-type: none"> <li>• Check the sampling line and connectors for leakage.</li> </ul>
Gas exchange values seem unreliable.	<ul style="list-style-type: none"> <li>• Check the ventilation mode.</li> <li>• Check the inspired oxygen concentration and correct if necessary (max. 85%).</li> <li>• If the expiration gas flow during the end phase of the patient's expiration is close to zero for more than two seconds before the next inspiration starts, the ventilator's bypass flow may affect the measurement. You can reduce this effect by adding a suitable spacer with a 5 to 10 ml dead space (e.g., a straight T-adapter) between the Y-piece and the D-lite or the Pedi-lite adapter.</li> </ul>
Module does not work.	<ul style="list-style-type: none"> <li>• Check and clean the filter if necessary.</li> <li>• Check the water trap. If it was too full, liquid may have entered the module. Replace the module and have it checked by authorized service personnel.</li> </ul>
No gas exchange values.	<ul style="list-style-type: none"> <li>• Check that the gas sampling line is not connected to the sample gas out connector.</li> </ul>
VO ₂ values are non-physiologic.	<ul style="list-style-type: none"> <li>• Verify that the oxygram curve is stable.</li> <li>• Change the sampling line.</li> <li>• Check the D-lite placement.</li> </ul>
Are gas exchange values accurate with 100% oxygen?	No, gas exchange measurements are not possible when the FiO ₂ > 85%. This is also indicated on screen by the replacement of numbers by ---. Please also note that full measurement accuracy is obtained when FiO ₂ is less than 65%. Between 65% and 85% FiO ₂ , the accuracy is reduced to +/-15%

## Gas exchange

Problem	Solution
Can I have the EE and RQ value trend information with one-minute resolution?	You can have a one-minute average of EE and RQ numbers on the numeric trend data page. These numbers are updated according to the selected time interval. By selecting EE and RQ into the graphical trends, you will see them updating every minute.
Can the gas exchange modules be used with active humidification?	Yes, they can. Use the D-lite+/Pedi-lite+ flow sensor for humid conditions. If HME is used, both the D-lite/Pedi-lite and D-lite+/Pedi-lite+ can be used.
Can the gas exchange modules be used with pediatric patients?	Yes, for those pediatric patients whose respiration rate is below 35 breaths/minute. When monitoring pediatric patients, use the Pedi-lite sensor and select the sensor accordingly from the monitor menu.
How can I ensure that the $VCO_2$ and $VO_2$ values are correct?	Always make sure that you are using correct accessories and that the measurement setup and patient connections are correct.
Why does the RQ value rise above 1.0?	The physiological range of RQ is usually between 0.7 and 1.0. If the value is out of this range, check the measurement setup.
Why does the RQ value sometimes show unphysiological values such as $RQ < 0.6$ ?	Usually this is due to a non-steady state: the ventilator settings have been changed, $FiO_2$ has changed, the ventilation is irregular.
Why is there no EE and RQ data in the trend history?	If the RQ is out of the physiological range ( $<0.6$ or $>1.3$ ), the monitor does not store the EE and RQ values in the trend history or use them for calculating the average values.
Why is there no numeric EE and RQ data in the parameter window although the monitor shows the data of $VCO_2$ and $VO_2$ ?	<p>EE and RQ are averaged values. It takes some time to initialize the averaging buffer (depending on the selected averaging time) to display data. When a patient is admitted/a case is started, no EE and RQ values are shown for 10 minutes. After that, they are gray until there is enough data for average calculations.</p> <p>If RQ is not within the physiological range, the values will not be added to the averaging buffer.</p> <p>The bar in the lower part of the parameter window indicates the amount of data that the monitor uses for performing the average calculations.</p>
Why are the EE and RQ values shown in gray?	EE and RQ are gray when there is not enough ( $> 1/5$ of the selected averaging time) valid data available for reliable calculations.



# Entropy

## Entropy compatibility

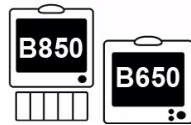

All features of this measurement are available for both monitors.

For detailed information regarding module, monitor, and accessory compatibility, see the supplemental information manual.

## Entropy safety precautions

### Entropy warnings

**WARNING**

Make sure that the electrodes, sensor and connectors do not touch any electrically conductive material, including earth.

**WARNING**

When using an electrosurgery unit, note that the measurement cables do not incorporate means to protect against burns in case of a defective ESU return electrode. To avoid burns at the monitor measurement sites, ensure the following:

- Proper contact of the ESU return electrode to the patient.
- ESU return electrode near the operating area.
- Measurement electrodes, leadwires and probes far from the surgical site and the ESU return electrode.

**WARNING**

— DEFIBRILLATOR PRECAUTIONS — Patient signal inputs labeled with the CF and BF symbols with paddles are protected against damage resulting from defibrillation voltages. To ensure proper defibrillator protection, use only the recommended cables and leadwires.

The yellow general warning symbol on the module refers to this warning.

**WARNING**

— DEFIBRILLATOR PRECAUTIONS — Proper placement of defibrillator pads in relation to the electrodes is required to ensure successful defibrillation.

**WARNING** Ensure that the sensor is placed on the patient's forehead according to the instructions. Placing the sensor in a way other than instructed might result in risks during patient defibrillation.

## Entropy cautions

- CAUTION** Strong 30-40 Hz magnetic fields may cause erroneous Entropy measurement. Do not use devices with such a field close to the module or sensor.
- CAUTION** Diathermy and external interference may degrade the performance.
- CAUTION** The Entropy measurement is always to be used only as an adjunct to other physiological parameters. Clinicians are advised to use their knowledge and experience when making clinical judgements. Entropy values are not to be used as sole indicators of the patient status.
- CAUTION** Check the sensor expiration date on the sensor package. Do not use expired sensors.
- CAUTION** Do not use a sensor for more than 24 hours.
- CAUTION** Long-term use of the electrodes may degrade condition of the skin especially on patients with liver diseases.
- CAUTION** Automatic sensor check may need to be disabled if the 70 Hz impedance check signal interferes with other equipment, such as EEG module with evoked potentials measurement.
- CAUTION** Allow the cable to dry completely after cleaning. Moisture and dirt on the connector can affect the measurement accuracy.

## Entropy indications for use

The GE Healthcare Entropy module, E-ENTROPY, and accessories are indicated for adult and pediatric patients older than 2 years within a hospital for monitoring the state of the brain by data acquisition of electroencephalograph (EEG) and frontal electromyograph (FEMG) signals. The spectral entropies, Response Entropy (RE) and State Entropy (SE), are processed EEG and FEMG variables. The Entropy measurement is to be used as an adjunct to other physiological parameters.

In adult patients, Response Entropy (RE) and State Entropy (SE) may be used as an aid in monitoring the effects of certain anesthetic agents, which may help the user titrate anesthetic drugs according to the individual needs of adult patients. Furthermore in adults, the use of Entropy parameters may be associated with a reduction of anesthetic use and faster emergence from anesthesia.

The Entropy module is indicated for use by qualified medical personnel only.

## Entropy measurement limitations

- This measurement is available in OR and PACU software packages only.

- Entropy measurement is not indicated for pediatric patients younger than two years old.
- Entropy is not validated with patients undergoing sedation.
- Unusual or excessive electrical interference is a potential cause for artifact. During extended periods of electrocautery there may not be any good EEG epochs, and Entropy values will not be displayed.
- ECG, frequent eye movements, coughing, muscle rigidity and patient movement cause artifact and may interfere with the measurement. Epileptic episodes may also cause interference.
- Entropy readings may be inconsistent when monitoring patients with neurological disorders, traumas or their sequelae.
- Entropy readings may be inconsistent when using benzodiazepines, nitrous oxide or ketamine as anesthetics.
- Psychoactive medication or very high opiate doses may suppress EEG and cause inconsistent Entropy readings.
- Cooling the patient may suppress their EEG and cause inconsistent Entropy readings.

## Entropy points to note

- A portion of the Entropy software is derived from the RSA Data Security, Inc. MD5 Message-Digest Algorithm.
- Entropy sensors are disposable, for single-patient use only, and not made with natural rubber latex.
- Make sure that the sensor connectors of the sensor cable are not in contact with fluids.
- Always ensure that the sensor is properly attached to the patient and connected to the cable.
- Prior to using Entropy as an adjunct to guide anesthesia care, it is recommended to review important situations and limitations that can influence the Entropy number. GE recommends that clinicians review the following practice advisory that includes a section on brain function monitoring: The American Society of Anesthesiologists, Practice Advisory for Intraoperative Awareness and Brain Function Monitoring (Anesthesiology 2006; 104: 847-64). Clinicians are also recommended to maintain current knowledge of all required regulatory, practice or research information on brain function monitoring and related topics.

## Entropy measurement setup

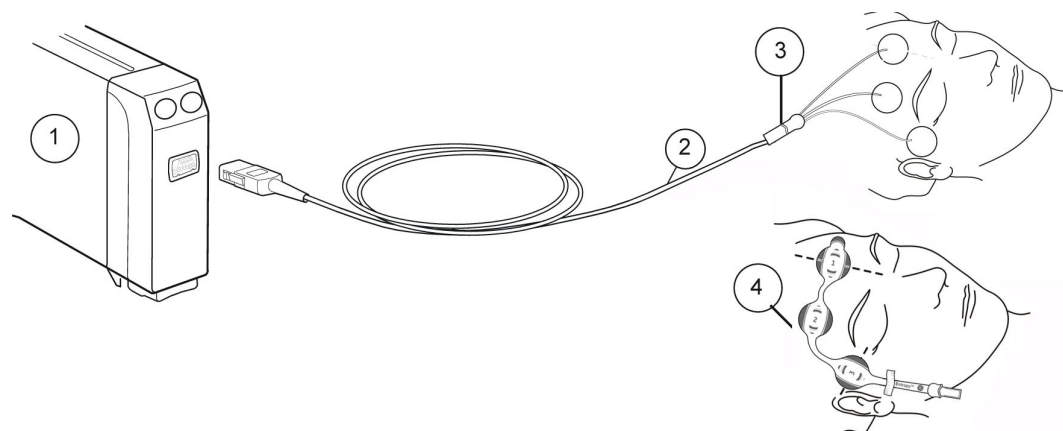

### Entropy equipment to patient connection



1. Module with Entropy measurement capability
2. GE Entropy sensor cable
3. GE Entropy sensor
4. Entropy EasyFit sensor

## Entropy module keys

There are two keys on the module. Depending on the module version either the text only or symbol only appear on the keys, and the table below covers both versions:

 or <b>Entropy</b>	Opens or closes the Entropy menu on the screen.
 or <b>Check Sensor</b>	Starts the manual sensor check.

## Preparing the patient for Entropy measurement

1. Connect the Entropy sensor cable to the module.
2. Clean the application site according to the sensor's instructions for use and let it dry before attaching the sensor.
3. Place the Entropy sensor on the patient's forehead; see sensor package for instructions.
4. Connect the sensor to the Entropy sensor cable.
5. Observe the results of the automatic sensor check in the parameter window.
6. The measurement starts automatically after the sensor has passed the check.

## Checking the Entropy measurement

1. Check that the sensor/electrode passes the sensor/electrode check when you are starting to monitor a new patient.

## Using the Entropy measurement

### Selecting the display format for Entropy

You can select which Entropy parameters are shown in the parameter windows.

1. Press the  module key, or select the Entropy parameter window.
2. Select **Setup**.
3. Select an option from the **Display Format** list:
  - **RE** = Response Entropy
  - **SE** = State Entropy
  - **RE+SE** = both of the above
  - **All** = RE, SE and Burst Suppression Ratio (BSR)

### Selecting the Entropy scale

This selection affects the Entropy waveform and snapshots.

1. Press the  module key, or select the Entropy parameter window.
2. Select **Setup**.
3. Select a value from the **Scale  $\mu V$**  list.

### Selecting the EEG sweep speed

This setting determines the drawing speed for the EEG waveform.

1. Press the  module key, or select the Entropy parameter window.
2. Select **Setup**.
3. Select a value from the **EEG Sweep Speed** list.

The smaller the value, the slower the sweep speed.

**NOTE** This setting is available in BIS, EEG and Entropy setups. Regardless of where you change it, it will affect all three parameters.

### Showing Entropy microtrend

You can select an Entropy microtrend to the screen together with numeric values.

1. Press the  module key, or select the Entropy parameter window.
2. Select **Setup**.
3. Select **Show Entropy Microtrend**.

## Selecting the Entropy trend length

This setting affects the width of the Entropy microtrend in the parameter window.

1. Press the  module key, or select the Entropy parameter window.
2. Select **Setup**.
3. Select a trend length from the **Trend Length** list.

## Using the manual Entropy sensor check

Whenever required, you can perform the sensor check manually. Press the

 module key, or:

1. Press the  module key, or select the Entropy parameter window.
2. Select **Setup** > **Check Sensor**.
3. Observe the results on the screen. Do not press the sensor during the check to avoid signal noise.

The measurement continues automatically after the sensor has passed the check.

## Using the automatic Entropy sensor check

Sensor impedance check is performed at the start up whenever a sensor or an electrode is attached. If the automatic sensor check has been selected on, the check is also performed periodically every 10 minutes.

1. Press the  module key, or select the Entropy parameter window.
2. Select **Setup**.
3. Select **Check Sensor** > **Automatic**.

## Bypassing the Entropy sensor check

If the sensor does not pass the impedance check, this option becomes selectable. It allows you to start the measurement without completing the sensor check. In this case, the measurement may be unreliable.

1. Press the  module key, or select the Entropy parameter window.
2. Select **Setup**.
3. Select **Bypass Check**.

## Setting Entropy alarm limits

You can set the limit alarms on or off and adjust their activation limits according to your needs.

1. Press the  module key, or select the Entropy parameter window.
2. Select **Setup**.

3. Select the parameter (**RE** or **SE**).

**NOTE**

If the feature is not active, the alarm limits are greyed out. Select **Alarm On** to set the alarms.

## Stopping the Entropy measurement

1. Remove the Entropy sensor from the patient.
2. Disconnect the sensor from the sensor cable.
3. Discard the sensor.

## Entropy measurement basics

### Entropy measurement description

EEG signals reflect the underlying state of brain activity. As a person falls asleep or is anesthetized, the brain function (activity) starts to decrease and becomes more orderly and regular. EEG changes from irregular to more regular patterns when anesthesia deepens. Similarly, frontal EMG quiets down as the deeper parts of the brain are increasingly saturated with anesthetics.

Entropy measurement is based on processing of raw EEG and FEMG signals by using the Entropy algorithm, a GE application of Spectral Entropy. The algorithm is published: Viertiö-Oja H et al. Description of the Entropy algorithm as applied in the Datex-Ohmeda S/5 Entropy Module. (Acta Anaesthesiologica Scandinavica 2004; Volume 48: Issue 2:154-161, 2004).

Entropy measures irregularity of EEG and FEMG. The GE Entropy measurement devices are responsible for EEG and FEMG signal acquisition, amplification, filtering and digitization and electrode impedance measurement.

### Entropy parameters

RE is a fast reacting parameter, which measures EEG and FEMG in the frequency range 0.8 Hz to 47 Hz. Its reaction time is two seconds. It may give an indication of the patient's reaction to external stimuli, such as intubation and skin incision, if neuromuscular blocking agents are not used.

SE is a more stable and robust parameter, which measures EEG in the frequency range of 0.8 Hz to 32 Hz. Its reaction time is 15 seconds. SE may be used to assess the effect of certain anesthetic drugs on the brain.

### Entropy frequency and display ranges

Parameter	Display range	Cortical EEG, frequency range	Facial EMG, frequency range
RE	0 to 100	0 Hz to 32 Hz	32 Hz to 47 Hz
SE	0 to 91	0 Hz to 32 Hz	no measurement

### How to interpret the Entropy values

High values of Entropy indicate high irregularity of the signal, signifying that the patient is awake. A more regular signal produces low Entropy values, which can be

associated with low probability of consciousness. A decrease in Entropy may enable the physician to observe the moment when the patient loses responsiveness. During continued anesthesia, both Entropies stabilize.

During general anesthesia with adequate anesthesia and hypnosis the RE and SE values will be within a narrow range or equal. The numbers will also merge during profound neuromuscular paralysis with neuromuscular blocking agents since the patient's facial muscles are unable to react.

RE is typically higher during periods prior to induction and before wake-up. If the numbers diverge (RE exceeds SE) during general anesthesia, it indicates that the facial muscles are activated. This may happen due to noxious stimuli. SE value may remain within a constant range if the level of hypnosis is adequate. A quick rise in RE may give an early warning of impending wake-up.

Patients emerging from general anesthesia will demonstrate a rise in both the RE and SE values.

## Relation of Entropy values to EEG and patient status

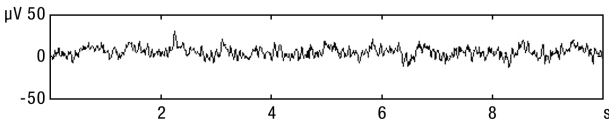
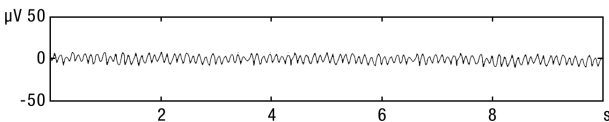
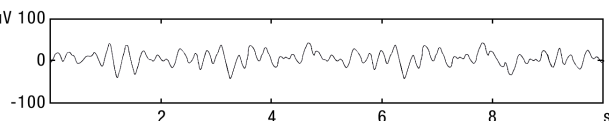
<ul style="list-style-type: none"> <li>• Entropy values: High Entropy values</li> <li>• EEG: Irregular EEG</li> <li>• Patient Status: Awake</li> <li>• Graphical display:</li> </ul>	
<ul style="list-style-type: none"> <li>• Entropy values: High Entropy values</li> <li>• EEG: Irregular EEG</li> <li>• Patient Status: Deepening sedation</li> <li>• Graphical display:</li> </ul>	
<ul style="list-style-type: none"> <li>• Entropy values: Low Entropy values</li> <li>• EEG: Regular EEG</li> <li>• Patient Status: Moderate anesthesia</li> <li>• Graphical display:</li> </ul>	
<ul style="list-style-type: none"> <li>• Entropy values: Low Entropy values</li> <li>• EEG: Regular EEG</li> <li>• Patient Status: Very deep anesthesia</li> </ul>	



- Graphical display:

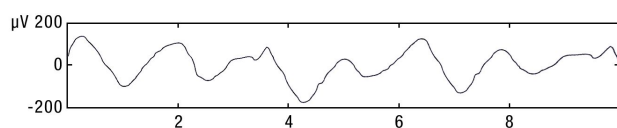

- Entropy values: Low Entropy values
- EEG: Regular EEG
- Patient Status: Suppressed EEG
- Graphical display:

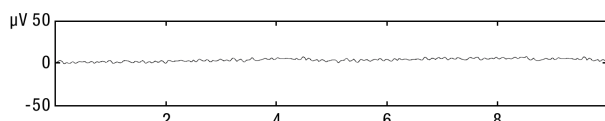

## Entropy range guidelines

### NOTE

Individual patients may show different values. These are only guidelines.

RE	SE	Description
100	90	Awake
60–40	60–40	Low probability of recall, clinically adequate level for most surgical operations
<40	<40	Deep anesthesia
0	0	Suppressed EEG

## Burst suppression ratio (BSR)

BSR is defined as the percentage of time of suppressed (isoelectric, flatline) EEG periods during the last minute of observation. Emergence of burst suppression pattern may indicate very deep anesthesia, hypothermia or ischemia.

Typically, during general anesthesia, in the absence of requirements for profound levels of anesthesia, BSR is 0%. Higher levels of burst suppression indicate very deep hypnosis/unconsciousness level. Burst suppression generally emerges with Entropy values below 40, but may not appear even with very low Entropy values.

## Entropy practicalities

- It is very important to ensure good contact between the sensor electrodes and skin. With careful skin preparation, correct sensor placement and use of correct cable, the skull and sinuses between the electrodes and the brain interfere minimally with the signal acquisition. See the sensor instructions for use for more detailed information.
- A high quality EEG signal is the prerequisite for successful Entropy calculation. Displaying the raw EEG within the Entropy EEG waveform adjacent to the Entropy values may help the user to confirm the signal quality. Raw EEG on the screen may also enable the clinician to view the EEG for recognizable and clinically relevant patterns of EEG activity.
- Do not use other sensors than Entropy sensors by GE.

- Entropy is not a parameter for monitoring neuromuscular blockade. Though RE may give an indication of the patient’s reaction to external stimuli, such as intubation and skin incision, the level of neuromuscular blockade should be assessed with NMT, which is an active assessment of the effects of neuromuscular blockade agents on the neuromuscular junction.
- Neuromuscular blocking agents (NMBA) administered in surgically appropriate doses are not known to affect the EEG, but are known to have an effect on the EMG. RE values may drop in response to NMBA administration, due to paralysis of facial muscles.
- The Entropy sensors and cable are designed to be defibrillation-proof.

## Entropy troubleshooting

Problem	Solution
Entropy values seem unstable	<ul style="list-style-type: none"> <li>• Check that the sensor is not dried out.</li> <li>• Check the sensor attachment and placement.</li> <li>• Check the patient status.</li> </ul>
Entropy EEG signal is noisy	<ul style="list-style-type: none"> <li>• Remove disturbing equipment from the proximity of the Entropy module or sensor.</li> <li>• Check the sensor’s contact with skin.</li> <li>• Check electrodes.</li> </ul>
Entropy EEG signal is poor	<ul style="list-style-type: none"> <li>• Check the sensor’s contact with skin.</li> <li>• Check electrodes.</li> </ul>
Entropy EEG waveform and numbers do not correspond	<ul style="list-style-type: none"> <li>• Check raw EEG as impedance check may cause a temporary increase in the numeric values.</li> <li>• Check the patient’s overall status.</li> </ul>
Entropy readings seem inconsistent with the patient status	<ul style="list-style-type: none"> <li>• Check raw EEG for QRS or other artifact.</li> <li>• Check electrode placement.</li> </ul>
There is a sudden drop in values.	<p>A sudden drop in values can be caused by the following:</p> <ul style="list-style-type: none"> <li>• Bolus administration of intravenous anesthetics.</li> <li>• Increase in inhalation anesthesia level.</li> <li>• Administration of other medication affecting EEG/FEMG.</li> </ul>
There is an unexpected increase in values.	<p>An unexpected increase in values can be caused by the following:</p> <ul style="list-style-type: none"> <li>• Change in infusion pump settings for intravenous anesthetics.</li> <li>• Change in vaporizer settings, or fresh-gas flow rate.</li> <li>• Volume loading with infused fluids.</li> <li>• Fault in the operation of anesthetic delivery systems.</li> <li>• Impedance check.</li> </ul>

## Entropy reference studies

### Entropy reference studies supporting reduction of drugs

The following studies support the indication for reducing the amount of certain hypnotic drugs and enabling faster emergence from anesthesia:

- Vakkuri A, Yli-Hankala A, Sandin R, Mustola S, Hoymork S, Nyblom S, Talja P, Sampson T, Van Gils M, Viertiö-Oja H: Spectral Entropy monitoring is associated with reduced propofol use and faster emergence in propofol-nitrous oxide-alfentanil anesthesia *Anesthesiology* 2005, Volume 103, Issue 2:274-279, 2005  
In the study reported by Vakkuri et al using propofol, Entropy monitoring helped in determining the titration rates of propofol especially during the last part of the procedures. This is indicated by higher entropy values, decreased consumption of propofol ( $P < 0.001$ ), and shorter recovery times in the Entropy monitored group
- Aimé I, Verroust N, Masson-Lefoll C, Taylor G, Laloe PA, Liu N, Fischler M (2006): Does monitoring bispectral index or spectral entropy reduce sevoflurane use? *Anesth Analg* 103: 1469-77  
In the study by Aimé et al, the authors reported that they were able to cut down the sevoflurane usage by 29% in the Entropy monitored group, when compared to the standard clinical practice.

### Entropy reference studies supporting titration of drugs

The following studies support the indication that use of Entropy may help the user to titrate certain anesthetic drugs according to the individual needs of adult patients:

- Vanluchene A.L.G., Vereecke H, Thas O, Mortier E.P, Shafer S.L, Struys M. M. R. F Spectral Entropy as an Electroencephalographic Measure of Anesthetic Drug Effect: A Comparison with Bispectral Index and Processed Midlatency Auditory Evoked Response *Anesthesiology* 2004; Volume 101: Issue 1:34-42.  
In this study by Vanluchene et al using propofol, the authors conclude that both SE and RE seem to be useful measures for anesthetic drug effect, with low baseline variability and accurate burst suppression detection.
- Vanluchene A.L.G, Struys M. M. R. F, Heyse B. E. K, Mortier E.P: Spectral entropy measurement of patient responsiveness during propofol and remifentanil. A comparison with the bispectral index. *British Journal of Anaesthesia* 2004; Volume 93: Issue 5: 645-54.  
In this study by Vanluchene et al using propofol, the authors conclude that loss of response to verbal command and loss of response to noxious stimulation were accurately detected by Entropy and BIS.
- Vakkuri A, Yli-Hankala A, Talja P, Mustola S, Tolvanen-Laakso H, Sampson T, Viertiö-Oja H: Time-frequency balanced spectral entropy as a measure of anesthetic drug effect in central nervous system during sevoflurane, propofol, and thiopental anesthesia *Acta Anaesthesiologica Scandinavica* 2004; Volume 48: Issue 2: 145-153, 2004.  
In this study using sevoflurane, propofol and thiopental, the authors found that SE and RE distinguished excellently between conscious and unconscious states. The authors conclude that RE indicates emergence from anesthesia earlier than SE or BIS.

## Reference studies regarding pediatric use of Entropy

Entropy has been used with pediatric patients in the following studies:

- Klockars JGM, Hiller A, Ranta S, Talja P, van Gils MJ, Taivainen T: Spectral entropy as a measure of hypnosis in children. *Anesthesiology* 2006, 104: 708-17.  
In the study by Klockars et al using sevoflurane, the authors used Entropy monitoring on anesthetized children.
- Davidson A.J, Kim M.J, Sangolt G.K: Entropy and Bispectral Index During Anaesthesia in Children. *Anesthesia and Intensive Care* 2004; Volume 32: Issue 4: 485-493.  
In this study by Davidson et al used Entropy Module on toddlers and children during isoflurane and nitrous oxide anesthesia.
- Davidson A, Huang G, Rebmann C, Ellery C: Performance of Entropy and Bispectral Index as measures of anaesthesia effect in children of different ages. *British Journal of Anaesthesia* 2005, 95: 674-9.  
In this study by Davidson et al using sevoflurane, the authors concluded that there was no difference in performance of Entropy Module and BIS in children.
- Choi SR, Lim YH, Lee JH & Chung CJ: Spectral entropy monitoring allowed lower sevoflurane concentration and faster recovery in children. *Acta Anaesthesiologica Scandinavica* 54 (7): 850–862; Aug 10 2010.

# Neuromuscular transmission

## NMT compatibility

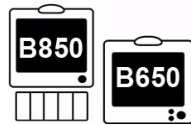

All features of this measurement are available for both monitors.

For detailed information regarding module, monitor, and accessory compatibility, see the supplemental information manual.

## NMT safety precautions

### NMT warnings

- |                |                                                                                                                                                                                                                                                                                                                                                                                                                                                                                                                                    |
|----------------|------------------------------------------------------------------------------------------------------------------------------------------------------------------------------------------------------------------------------------------------------------------------------------------------------------------------------------------------------------------------------------------------------------------------------------------------------------------------------------------------------------------------------------|
| <b>WARNING</b> | Make sure that the lead set clips or snaps do not touch any electrically conductive material including earth.                                                                                                                                                                                                                                                                                                                                                                                                                      |
| <b>WARNING</b> | Do not place the NMT stimulating electrodes on the patient's chest. Application of the electrodes near the thorax may increase the risk of cardiac fibrillation.                                                                                                                                                                                                                                                                                                                                                                   |
| <b>WARNING</b> | When using an electrosurgery unit, note that the measurement cables do not incorporate means to protect against burns in case of a defective ESU return electrode. To avoid burns at the monitor measurement sites, ensure the following: <ul style="list-style-type: none"> <li>• Proper contact of the ESU return electrode to the patient.</li> <li>• ESU return electrode near the operating area.</li> <li>• Measurement electrodes, leadwires and probes far from the surgical site and the ESU return electrode.</li> </ul> |
| <b>WARNING</b> | — DEFIBRILLATOR PRECAUTIONS — Patient signal inputs labeled with the CF and BF symbols with paddles are protected against damage resulting from defibrillation voltages. To ensure proper defibrillator protection, use only the recommended cables and leadwires.                                                                                                                                                                                                                                                                 |
| <b>WARNING</b> | — DEFIBRILLATOR PRECAUTIONS — Proper placement of defibrillator pads in relation to the electrodes is required to ensure successful defibrillation.                                                                                                                                                                                                                                                                                                                                                                                |

## NMT cautions

- |                |                                                                                                                                      |
|----------------|--------------------------------------------------------------------------------------------------------------------------------------|
| <b>CAUTION</b> | Always stop the NMT measurement before handling the stimulating electrodes.                                                          |
| <b>CAUTION</b> | Never subject a patient with an implanted electronic device to electrical stimulation without consulting a medical specialist first. |
| <b>CAUTION</b> | If used in close proximity to shortwave or microwave therapy equipment, stimulator output may become unstable.                       |

## NMT measurement limitations

- This measurement is not available in the NICU software package.
- NMT measurement is not indicated for pediatric patients weighing less than 5 kg (11 lbs).
- Pediatric MechanoSensor is validated for children weighing 5 to 20 kg (11 to 44 lbs).
- Electrosurgery may cause incorrect measurement results.
- NMT measurement is not indicated for patients with known abnormal function of neuromuscular junction.

## NMT points to note

- Start monitoring before the administration of a muscle relaxant drug (but after the induction of sleep in general anesthesia) to prevent voluntary muscle contraction and tension from interfering with the reference search.
- When placing the electrodes, make sure that they do not touch each other.
- Do not place electrodes on areas with excessive body hair or lesions.
- If the electrodes are placed incorrectly, wrong nerves are stimulated and this causes wrong muscle response.
- When multiple nerves are stimulated, the measured response may be affected by electrical activity of other muscles.
- If the stimulation electrodes are placed very close to the palm of the hand, the muscles are stimulated directly by the stimulation pulses.
- Do not apply stimulation across or through the head, directly on the eyes, covering the mouth, on the front of neck (especially over the carotid sinus), or from electrodes placed on the chest and the upper back or crossing over the heart.
- If the current is too strong, it may stimulate the muscles too much.
- Moving or touching the patient during measurement may cause incorrect results.
- For safe extubation, the TOF% should be higher than 90. Also assess other clinical signs.

## Checking the NMT measurement

1. Always check the electrode quality.

- Check that the electrodes are correctly positioned on the ulnar nerve and the message **Supramax search** is displayed. Ensure that you get a stimulus response. If the supramaximal stimulus current is not found, the message **Supramax not found** is displayed.

## NMT measurement setup

### NMT equipment to patient connection

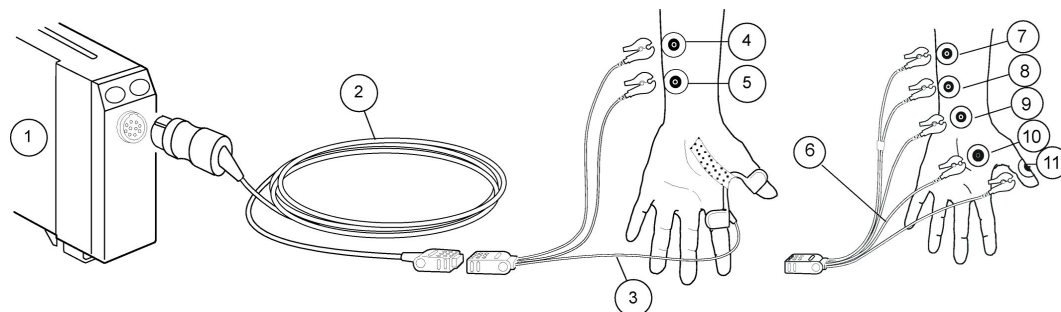

- Module with NMT measurement capability
- NMT sensor cable
- MechanoSensor or Pediatric MechanoSensor lead wire set
- Electrode, white lead connection site for nerve stimulation
- Electrode, brown lead connection site for nerve stimulation
- ElectroSensor leadwire set
- White stimulating electrode
- Brown stimulating electrode
- Electrode, black lead connection site, ground
- Electrode, green lead connection site, recording muscle-contraction effect
- Electrode, red lead connection site, recording muscle-contraction effect

### NMT module keys

There are two keys on the module:

<b>Start-up</b>	<ul style="list-style-type: none"> <li>Starts the search for supramaximal current and reference level.</li> <li>Proceeds with the selected measurement cycle.</li> </ul>
<b>Stop Continue</b>	<ul style="list-style-type: none"> <li>Interrupts monitoring.</li> <li>Restarts monitoring of the same patient.</li> </ul>

### Preparing the patient for NMT measurement

- Connect the NMT sensor cable to the module.
- Clean the skin at the NMT application area.
- When applying the electrodes, make sure that the entire electrode surfaces make an optimal contact to the skin.
- Always connect the white NMT stimulation lead to the proximal electrode.

5. Connect the sensor cable to the MechanoSensor or ElectroSensor leadwire set.

### Preparing the ElectroSensor setup

1. Place two electrodes for white and brown lead connection along the ulnar nerve. Prevent the electrodes from making contact with each other.
2. Place the electrodes for red and green lead connection as indicated in the illustration above.
3. Place the electrode for black lead connection where convenient, preferably between the stimulating and recording lead connection electrodes.

### Preparing the MechanoSensor setup

1. Place the two electrodes along the ulnar nerve. Prevent the electrodes from making contact with each other. Palpating the ulnar artery near the wrist area may be helpful in identifying the ulnar nerve.
2. Attach the sensor in the groove between thumb and index finger. If necessary, secure with narrow tape only.
3. Make sure that the sensor sets tightly in the groove and that the thumb can move freely. Do not immobilize the hand.

### Ulnar nerve and corresponding muscles

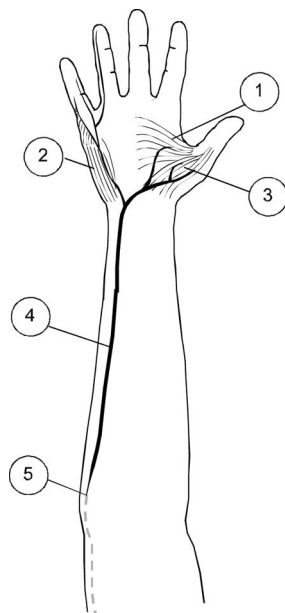

1. m. adductor pollicis
2. m. abductor digiti minimi (hypothenar)
3. m. flexor pollicis brevis (thenar)
4. n. ulnaris
5. medial epicondyle

### NMT alternative connections

If the patient's arm and/or hand cannot be used for NMT measurement, the foot may be an alternative measurement site. Place the electrodes for white and brown lead connection along the posterior tibial nerve (causing plantar reflexion of the great toe and foot) or peroneal nerve (stimulated behind the head of fibula). Place the electrodes for red and green lead connection site on the m. flexor hallucis brevis, and the electrode for black lead connection (ground) as indicated in the figure.



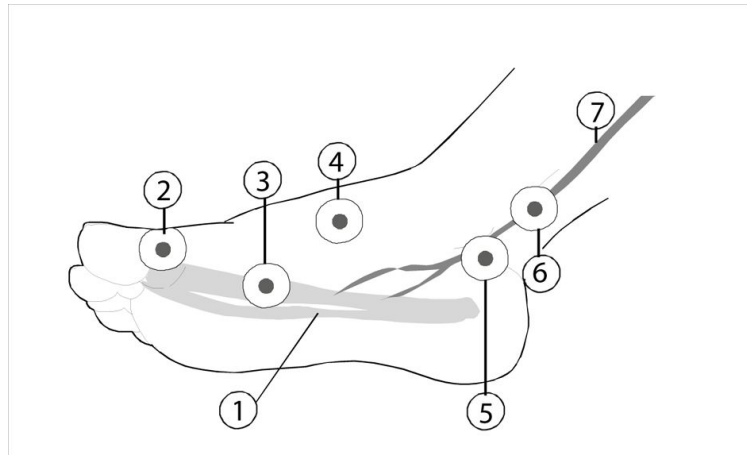

1. Flexor hallucis brevis
2. Red measuring electrode
3. Green measuring electrode
4. Black ground electrode
5. Brown stimulating electrode
6. White stimulating electrode
7. Tibial nerve

## NMT graphical trends on the monitor screen

Different NMT values have their own specific colors in the graphical trends. The values are shown as follows:

- white bars = Ratio% (TOF)
- green dots = T1%
- cyan bars = PTC
- magenta dots = Count

## Using the NMT measurement

### Starting the NMT measurement

Press the **Start-up** module key, or:

1. Select the NMT parameter window > **Setup**.
2. Select **Stimulus Mode** > **TOF**, **DBS** or **ST**.
3. Select **Start with** > **New patient**.
4. Select **Start-up**.

### Changing the NMT stimulus current

1. Select the NMT parameter window > **Setup**.
2. Select a value from the **Current** list.

## Changing the NMT cycle time

This selection also affects the recovery note.

1. Select the NMT parameter window > **Setup**.
2. Select a value from the **Cycle Time** list.

## Changing the NMT pulse width

1. Select the NMT parameter window > **Setup**.
2. Select a value from the **Pulse Width  $\mu$ s** list.

## Adjusting the NMT beep volume

You can set the beep value to best suit your care environment.

1. Select the NMT parameter window > **Setup**.
2. Select a value from the **Stimulus Beep Volume** list.

## Using the NMT recovery note

The recovery note alarms you with a single beep and the Block recovery message when the count reaches the value you have selected. It indicates that the patient is responding more clearly to the stimuli and the neuromuscular block is decreasing.

The note is activated according to the count number and cycle time:

- Cycle time less than one minute: The count must be below the selected limit in two consecutive measurements.
- Cycle time one minute or more, or manual measurement: At least one count must be below the selected limit.

To take this feature into use:

1. Select the NMT parameter window > **Setup**.
2. Select **Recovery Note**.
3. Select the count limit that will activate the note.

## Measuring deep relaxation

When no responses are detected for TOF stimulation, the post tetanic count (PTC) is the only way to measure the neuromuscular block. A tetanic stimulation (50 Hz) is generated for five seconds and post-tetanic responses to single-twitch stimulation are counted. The larger the PTC (the number of detected responses), the sooner the normal TOF responses return. To monitor the relaxation level, start a five-second tetanic stimulation:

1. Select the NMT parameter window > **Setup**.
2. Select **Start Tetanic/PTC**.

## Continuing the NMT measurement

To continue interrupted NMT measurement with the same patient and monitor, press the **Stop Continue** module key, or:

1. Select the NMT parameter window > **Setup**.

2. Select **Start with** > **Current patient**.
3. Select **Continue**.

## Restarting the NMT measurement in OR after induction

When you move the patient with the module to the OR and want to continue the measurement with the already found and determined current and reference values, use the restart function. Connect the module to the monitor and press the **Stop Continue** module key, or:

1. Select the NMT parameter window > **Setup**.
2. Select **Start with** > **Recall reference**.
3. Select **Restart**.

## Stopping the NMT measurement

Press the **Stop Continue** module key, or:

1. Select the NMT parameter window > **Setup**.
2. Select **Stop**.

## NMT alternative uses

### Local nerve and plexus localization

Single stimulation pulses may be helpful for determining the correct needle tip position from a local nerve in plexus procedures. The NMT module delivers single stimulation pulses at a selected rate until it is manually stopped. Muscle contractions from the stimulated innervating motoric nerve(s) may be observed. Note that you need specific accessories for this measurement.

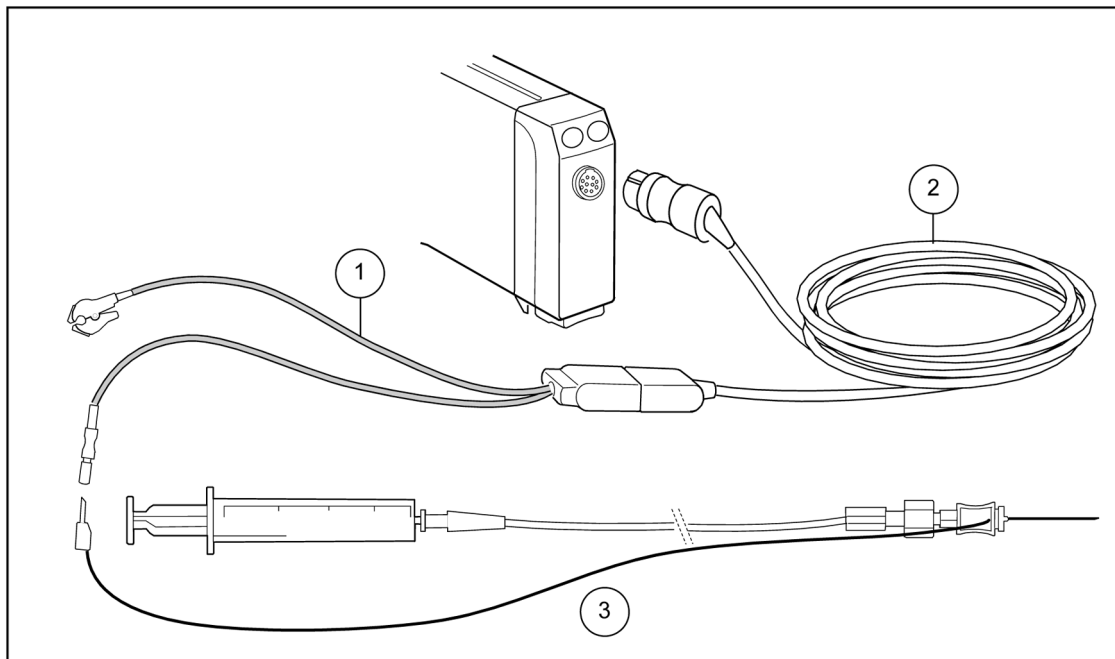

1. Regional block adapter
2. Sensor cable
3. Sterile needle

## Preparing for local nerve or plexus stimulation

1. Connect the E-NMT regional block adapter to the sensor cable.
2. Connect a disposable needle and syringe set to the adapter.
3. Press the **Start-up** module key and select a suitable current from the **Current mA** list that appears on screen. You can also do this by selecting the NMT parameter window > **Regional Block** tab > **Current mA**.
4. Start stimulation by selecting **Start**.
5. When the needle approaches the motor nerve, reduce the current. The pulse width is 40 ms and somewhat higher currents may be needed than in other similar systems.
6. When ready, stop the stimulation by pressing the **Stop Continue** module key, or by selecting the NMT parameter window > **Regional Block** > **Stop**.

## NMT measurement basics

### NMT measurement description

The GE NMT measurement devices are used for monitoring the relaxation of the patient and regional block stimulation for nerve location.

Neuromuscular transmission is the transfer of a motor nerve impulse over the neuromuscular junction. The GE NMT devices deliver stimulating electrical pulses to a motor nerve and the muscle response to these stimulations is measured.

Two electrodes are needed for electrical stimulation of a peripheral nerve. The resulting response can be measured with either two electrodes and a MechanoSensor, which measures movements between thumb and index finger, or an ElectroSensor using three recording electrodes.

The monitor searches for the stimulus current needed to activate all the fibers of the stimulated (recorded) muscles. The search begins with a 10 mA stimulus and the response is measured. The current is increased in steps of 5 mA until the increase in the current no longer increases the response. This maximal current is then automatically increased by 15%, resulting in the supramaximal current.

If the supramaximal current is not found or the response is too weak for searching a supramaximal current, the current is set to 70 mA.

### MechanoSensor and kinemyography (KMG)

Measurement with MechanoSensor is based on kinemyography principle. Two electrodes are placed on the ulnar nerve, and the innervating nerve is stimulated. The core of the MechanoSensor is a strip of piezoelectric polymer, housed inside the sensor. When this piezoelectric material changes shape due to muscle contraction as a result of nerve stimulation, the electrical charge in the material is redistributed, causing an electron flow to balance the charges. This flow can be measured as a potential change, which is proportional to the amount of material bending.

## ElectroSensor and electromyography (EMG)

Measurement with ElectroSensor is based on electromyography. Three electrodes are placed on the muscle, and the innervating nerve is stimulated. The recorded electrical activity of the muscle is inversely proportional to the degree of block.

### Stimulation modes

- Train of four, TOF: Recommended for most cases. It is also the default setting.
- Double burst stimulation, DBS: Useful when using the MechanoSensor. It enables better visual observation of the fading in responses.
- Post tetanic count, PTC: Used for estimating the relaxation level with tetanic stimulation.
- Single twitch, ST: Single twitch mode is practical when using depolarizing relaxants: in these cases, TOF% does not give any additional information about the patient status.

## How to interpret the NMT values

When neuromuscular block deepens, different stimulation modes may be needed to assess the relaxation status. The following table describes the depth of relaxation.

100	TOF%	20	4	Count	0	10	PTC	0
Light			RELAXATION METER			Deep		

### Train of four (TOF) mode

In TOF stimulus mode, four stimulation pulses are generated at 0.5 second intervals. The response is measured after each stimulus and the ratio of the fourth to the first response of the TOF sequence is calculated, resulting in TOF%.

With the ElectroSensor, T1% is displayed. If the reference is successfully found, a scale is also included. Scale markers represent 0%, 25%, 50%, 75% and 100% reference values. When no reference is available, no T1% value is displayed and the bars are not scaled.

When relaxation deepens, the TOF% declines until the fourth response disappears and no TOF% is available. The degree of neuromuscular block is then estimated from the number of responses, the count, which represents the number of responses detected to the four stimuli. The fewer the responses, the deeper the relaxation.

Number of responses, count	Neuromuscular block	Muscle power (% of control)
1	95%	5%
2	90%	10%
3	85%	15%
4	75%	25%

### Double burst stimulation (DBS) mode

DBS consists of two separate bursts. Each burst consists of three consecutive pulses at a 50 Hz frequency. The response ratio of the second to the first burst is calculated, resulting in DBS% (equivalent to TOF%).

## Post tetanic count (PTC) mode

When the response to the fourth TOF stimulation pulse disappears or the first twitch is very weak, the TOF% is not available and only the counts can be observed.

When the stimulation pulses no longer give any stimulation response, the count also disappears. To monitor the relaxation level, you can then start tetanic stimulation and estimate the relaxation level from the post tetanic count, PTC. Tetanic stimulation is a continuous stimulation of five seconds. After tetanic stimulation, single twitch stimulations are generated. The number of detected responses is counted and expressed as PTC. The fewer the responses, the deeper the relaxation.

If the responses do not fade away, a maximum of 20 responses are counted and the measurement value is replaced by >20.

After tetanic stimulation, NMT measurement is stopped for one minute. After that, the monitor automatically continues with the previously selected cycle.

## Single twitch (ST) mode

In single twitch stimulation one pulse is generated and its response is measured.

## NMT practicalities

- Normally, defasciculating doses of non-depolarizing neuromuscular blocking agents (precurarisation) do not affect the supramaximal current nor the reference value.
- Average lifetime of a MechanoSensor is two years, depending on the use. The sensor has been validated to last 700,000 twitches.

Inappropriate function of the measurement is often caused by incorrect accessory connection or misuse of the products. Therefore, note the following:

- Handle the sensor and cables carefully to maximize their lifetime.
  - Piezosensor inside the MechanoSensor is very sensitive to shocks.
- Attach the MechanoSensor correctly.
  - It is recommended to secure the MechanoSensor with a narrow tape. Wide tape might prevent adequate movement of the sensor with the thumb during the measurement.
- Check the quality of the stimulation electrodes.
  - Use GE approved NMT electrodes for stimulation. They are tested with the module and provide low impedance, which is crucial for accurate measurement.
  - Do not use the electrodes after their expiration date.
- Perform a visual check of the MechanoSensor or ElectroSensor and cable.
  - Regular visual checking of the cable and sensor is recommended. If you see any signs of broken cables or joints of the MechanoSensor, replace those parts.

## NMT troubleshooting

Problem	Solution
NMT reference search and measurement fail.	<ul style="list-style-type: none"> <li>• Check the electrode quality and positioning.</li> <li>• Replace stimulating electrodes.</li> </ul>
Measurement is disturbed.	<ul style="list-style-type: none"> <li>• Check the black ground electrode.</li> </ul>

Problem	Solution
<p>Difficulty in getting the response when locating the nerve for plexus stimulation</p>	<ul style="list-style-type: none"> <li>You may try using the local muscle response as an indication of current in the needle. If there is no response, the needle may be broken.</li> <li>Change the needle if necessary.</li> </ul>
<p>How can I verify the measurement reliability?</p>	<ul style="list-style-type: none"> <li>The reliability of the response can be estimated by observing the bar graph or the NMT trend.</li> <li>The bars of the bar graph should be in a smoothly descending order from left to right, and the NMT trend should indicate a fairly stable T1%. If this is not the case, the latest response is unreliable. Relaxation level does not usually decrease significantly in one minute even with short-acting relaxants.</li> <li>To verify your observations, start a new measurement manually right after the completion of the previous measurement. Sometimes the selected cycle time has been so long that the relaxation level has changed considerably between the measurements.</li> </ul>
<p>What can I do if the monitor does not find the supramaximal stimulation current?</p>	<ul style="list-style-type: none"> <li>If the monitor is unable to find the supramaximal stimulation current, check the electrode placement. The nerve may be outside the dense current flow or both the ulnar and median nerves may be stimulated; progressively more muscle activity is detected as the increasing stimulation current activates new motor units. Consult the figure below when placing the electrodes:</li> </ul> <div data-bbox="824 1163 997 1541" data-label="Image"> </div> <ol style="list-style-type: none"> <li>adductor pollicis</li> <li>abductor digiti minimi (hypothenar)</li> <li>flexor pollicis brevis (thenar)</li> <li>ulnar medial</li> <li>epicondyle</li> </ol> <ul style="list-style-type: none"> <li>Also, supramaximal current may not be found if the patient has anatomical and/or physiological anomalies.</li> </ul>





# EEG and auditory evoked potentials

## EEG compatibility

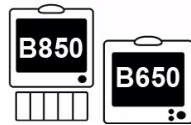

All features of this measurement are available for both monitors.

For detailed information regarding module, monitor, and accessory compatibility, see the supplemental information manual.

## EEG safety precautions

### EEG warnings

- WARNING** — DEFIBRILLATOR PRECAUTIONS — Patient signal inputs labeled with the CF and BF symbols with paddles are protected against damage resulting from defibrillation voltages. To ensure proper defibrillator protection, use only the recommended cables and leadwires.
- WARNING** — DEFIBRILLATOR PRECAUTIONS — Proper placement of defibrillator pads in relation to the electrodes is required to ensure successful defibrillation.
- WARNING** Make sure that the electrodes, leadwires, and connectors do not touch any electrically conductive material including earth.
- WARNING** When using an electrosurgery unit, note that the measurement cables do not incorporate means to protect against burns in case of a defective ESU return electrode. To avoid burns at the monitor measurement sites, ensure the following:
- Proper contact of the ESU return electrode to the patient.
  - ESU return electrode near the operating area.
  - Measurement electrodes, leadwires and probes far from the surgical site and the ESU return electrode.

## EEG cautions

- |                |                                                                                                                                                                                                                                                                                                             |
|----------------|-------------------------------------------------------------------------------------------------------------------------------------------------------------------------------------------------------------------------------------------------------------------------------------------------------------|
| <b>CAUTION</b> | Do not cover the EEG headbox as it may overheat.                                                                                                                                                                                                                                                            |
| <b>CAUTION</b> | EEG measurement is inherently very sensitive. Radiated electromagnetic fields may cause erroneous measurements at various frequencies. Do not use electrical radiating equipment close to the EEG measurement module. Details regarding radiated field strengths are given in the technical specifications. |

## EEG indications for use

The EEG module, E-EEG, and the headbox, N-EEG, and accessories are indicated for the monitoring of electroencephalograph (EEG), frontal electromyography (FEMG), and auditory evoked potentials (AEP) of all hospital patients.

The device is indicated for use by qualified medical personnel only.

## EEG measurement limitations

- This measurement is not available in the NICU software package.
- E-modules are not suitable for use with neonatal patients.
- External radiating devices may disturb the measurement.

## EEG points to note

- EEG is a very small signal and prone to artifacts such as movement, shivering, sweating, eye movement, frontal EMG, external electrical interference (other electrical devices), and internal (ECG) electrical interference.
- Good electrode contacts are imperative for high-quality EEG measurement.
- Keep electrical devices as far away from the patient as possible.
- Use short cables, or braid the long ones.
- Keep the headbox as close to the patient's head as possible.
- EEG findings are usually sensitive but not specific to the underlying cause.
- EEG findings should be assessed in conjunction with:
  - other monitor data and clinical assessment
  - neurological status of the patient
  - factors that influence EEG (like blood flow, neurological pathologies, underlying illnesses, and temperature).
- A cloth bandage over cup electrodes and around the patient's head may enhance good contact.

# EEG measurement setup

## EEG equipment to patient connection

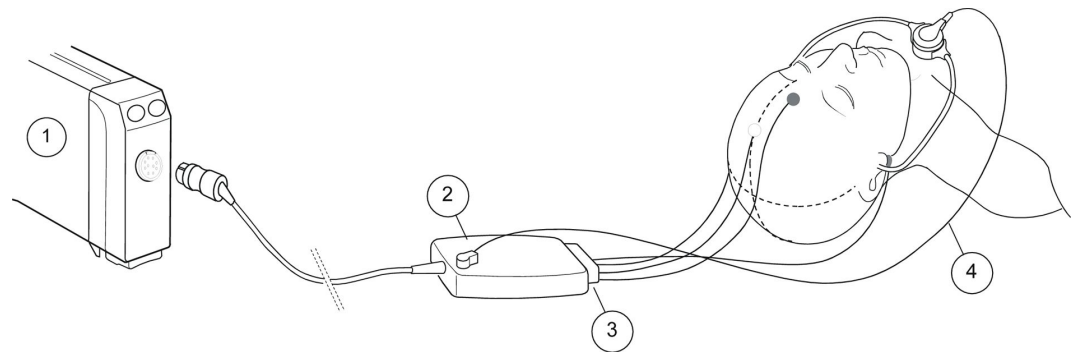

1. Module with EEG, AEP and FEMG measurement capability
2. EEG headbox and cable, N-EEG
3. EEG leadset: preconfigured or your own montage. EEG electrodes (cup, needle, or adhesive)
4. Earphones are required for AEP (auditory evoked potentials)

**CAUTION** Do not cover the EEG headbox as it may overheat.

**NOTE** When measuring both AEP and BIS or Entropy be aware of possible interference issues. Familiarize yourself with all of these measurements and their safety statements.

## EEG module keys

There are two keys on the module:

<b>EP Start/Stop</b>	Starts and stops auditory evoked potential measurement with the defined settings.
<b>Imp. Check</b>	Starts the manual measuring of the electrode impedance.

The same keys can be found on the headbox.

## EEG electrode sites

- Follow the electrode manufacturer’s instructions for the frequency of changing the electrodes.
- Only use electrodes that are intended for EEG measurement.
- Use one type of electrodes in the whole montage.

## International 10–20 system

The international 10–20 system’s standardized electrode locations:

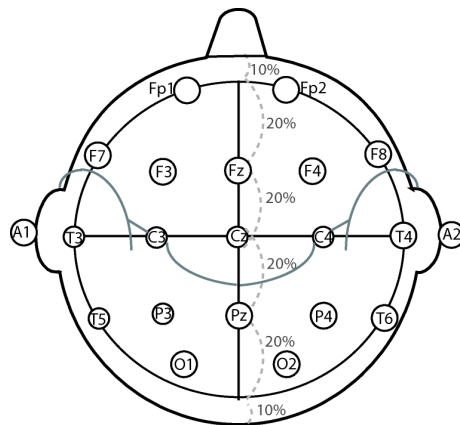

The numbers and letters of the 10-20 system refer to electrode locations:

- Odd numbered electrodes: placed on the left
- Even numbered electrodes: placed on the right
- Letters: F = frontal; T = temporal; C = central; P = parietal; O = occipital; Z = midline electrodes

## Connecting the EEG leadset

1. Connect the headbox to the module.
2. Select a suitable preconfigured leadset or your own montage.
3. Connect the leadset to the headbox.
4. Attach the electrodes to the patient as indicated in the leadset or according to your own montage.
5. Observe the results of the electrode check. Reconnect the electrodes if the impedance is too high.

## Attaching EEG electrodes within hair area

Preferably use cup electrodes if montage includes placements within hair area.

1. Mark the spots on the patient's head according to the montage you have chosen.
2. Comb or cut the hair away from the spots and rub the skin with abrasive paste to remove oil and grease.
3. Clean the skin with alcohol.
4. Attach the electrodes using conductive paste.

**NOTE**

Use water to detach the electrodes.

## Attaching EEG electrodes outside hair area

Preferably use adhesive electrodes if all montage placements are within skin area.

1. Clean the skin with alcohol.
2. Remove the electrode from its package and attach it to the desired location.
3. Press the electrode gently for several seconds to attach it.

## Attaching EEG needle electrodes

Always make sure that the needles are sterile.

1. Wipe the skin clean with alcohol.
2. Insert the needle into the subcutaneous area.
3. You may also use a small amount of paste to attach the cable to the patient's hair. This prevents the cables from pulling the needles out of the skin.

## Preconfigured EEG leadsets

A preconfigured leadset tells the monitor which montage (electrode positioning) is used. Therefore, no menu selections are necessary.

You can also define your own montage. Your own montages will not be automatically recognized when you start the measurement.

### NOTE

Since the monitor sets lead positions automatically according to the identification pin, make sure that you use preconfigured lead positions. If you change them, always update the montage settings according to the instructions.

## BASIC montage

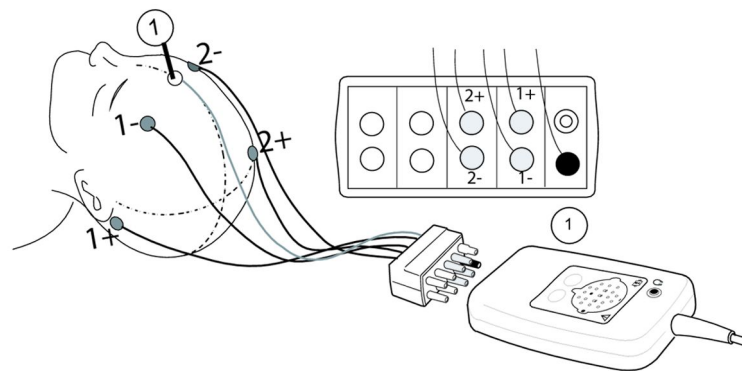

1. Ground

Montage	Settings	Electrodes
1. A1 -Fp1	Two channels, bipolar	Five adhesive electrodes
2. A2 - Fp		
Ground		

## GENERAL montage

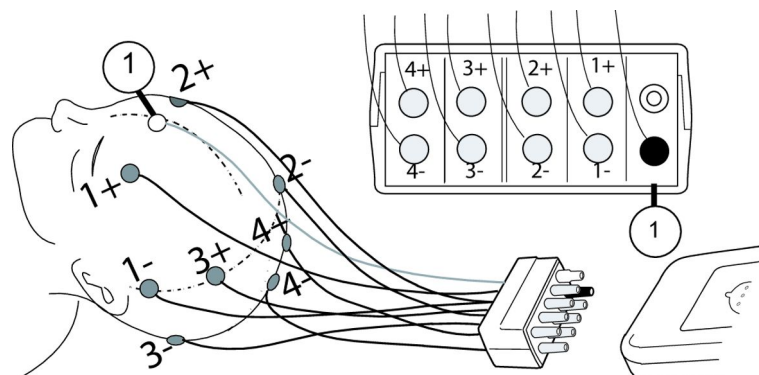

1. Ground

Montage	Settings	Electrodes
1. Fp1 – T3 2. Fp2 – T4 3. C3 – O1 4. C4 – O2 Ground	Four channels, bipolar	Nine cup electrodes

## Checking the EEG measurement

1. Check that the EEG waveforms are displayed after you have completed patient connections.
2. Perform impedance check to ensure proper electrode contact. When the leads are disconnected, the message **Leads off** is displayed.
3. Always check the electrode quality.

## EEG measurement on the monitor screen

In addition to the numeric parameters and the CSA (Compressed Spectral Array), you can also see the graphic presentation of EEG in the parameter window. This is a useful tool as it gives you a graphic presentation of the EEG numeric parameters.

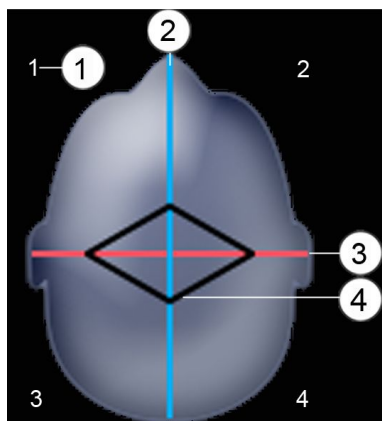

1. EEG channel (numbers 1 to 4), for example Fp1–T3.
2. Blue vertical line represents the parameter selected for **Numeric 2** (e.g., amplitude measured in  $\mu\text{V}$ ).
3. Red horizontal line represents the parameter selected for **Numeric 1** (e.g., SEF measured in Hz).
4. Black line ends touching the red and blue lines represent the channel-specific parameters for **Numeric 1** and **Numeric 2** (for instance, SEF and amplitude).

# Using the EEG measurement

## Starting the EEG measurement

EEG measurement starts automatically.

1. Observe the results of the electrode check.
2. Reconnect the electrodes if the impedance is too high.

## Selecting your own EEG montage

If you are using your own montage, you will have to select it from the list. Preconfigured montages will be automatically recognized.

1. Select the EEG parameter window.
2. Select **EEG** tab > **Montage**.
3. Select the montage from the **Select Montage** list.

### NOTE

Since the monitor sets lead positions automatically according to the identification pin, make sure that you use preconfigured lead positions. If you change them, always update the montage settings according to the instructions.

## Selecting the EEG scale

This setting defines the scale for EEG parameter windows, waveform and spectral displays

1. Select the EEG parameter window.
2. Select **EEG** tab > **Setup**.
3. Select a value from the **Scale  $\mu V$**  list.

## Selecting the EEG sweep speed

This setting determines the drawing speed for the EEG waveform.

1. Select the EEG parameter window.
2. Select **EEG** tab > **Setup**.
3. Select a value from the **EEG Sweep Speed** list.

The smaller the value, the slower the sweep speed.

### NOTE

This setting is available in BIS, EEG and Entropy setups. Regardless of where you change it, it will affect all three parameters.

## Selecting EEG numeric parameters

EEG numeric trends are available in the ED, ICU, and NICU software packages.

1. Select the EEG parameter window.
2. Select **EEG** tab > **Setup**.
3. Select a parameter from the **Numeric 1** list.

4. Select a parameter from the **Numeric 2** list.

## Selecting the SEF%

Set the percentage of the spectral power to define the edge frequency.

1. Select the EEG parameter window.
2. Select **EEG** tab > **Setup**.
3. Select a value from the **SEF %** list.

## Selecting the EEG frequency scale

The frequency selection affects the screen only, numeric parameters are always calculated from the entire measurement range. This selection affects the curve frequency scale in EEG parameter windows, CSA displays, and trend displays.

1. Select the EEG parameter window.
2. Select **EEG** tab > **Setup**.
3. Select a value from the **Freq. Scale Hz** list.

## Selecting the EEG impedance cycle time

You can set the time interval for the automatic impedance check.

1. Select the EEG parameter window.
2. Select **EEG** tab > **Setup**.
3. Select a value from the **Imped. Cycle** list.

## Selecting the CSA view

You can choose to view a graphical view of the spectrum as a single, continuously updating curve, CSA.

1. Select the EEG parameter window.
2. Select **EEG** tab > **View**.
3. Select **CSA**. Changing the view will erase the previous CSA content.

**NOTE** You can use the default time scale or select a value from the **CSA Time Scale** list.

## Selecting the time scale for CSA

1. Select the EEG parameter window.
2. Select **EEG** tab > **Setup** or **View**.
3. Select a value from the **CSA Time Scale** list.

**NOTE** Changing the scale will erase the previous CSA content.

## Selecting the EEG numerical view

You can choose to view a numeric list of all EEG parameters on all channels.

1. Select the EEG parameter window.



2. Select **EEG** tab > **View**.
3. Select **Numerical**.

## Checking EEG electrodes

Press the **Imp. Check** key on the module or headbox, or:

1. Select the EEG parameter window.
2. Select **EEG** tab > **View**.
3. Select **Check Electrodes**.

## Defining an EEG montage

You can define your own montage by plugging the leadwires directly into the headbox or by building your own leadset.

**NOTE** Since the monitor sets lead positions automatically according to the identification pin, make sure that you use preconfigured lead positions. If you change them, always update the montage settings.

1. Select the EEG parameter window.
2. Select **EEG** tab > **Montage**.
3. Select a montage (**Montage 4** to **Montage 8**) from the **Select Montage** list.
4. Go through the different menu items and select the options to suit the application. For instance, to rename the selected montage: select **Name Montage**, remove the previous name, type the new name in the **Name** field, and then select **Enter**. The name can contain nine characters at the most.
5. You can save the montage for later use by selecting **Save Montage** > **Yes**.

Your own montages will not be automatically identified by the monitor. You must select them from the menu when starting the measurement.

**NOTE** If you select **Factory**, all settings, including the name, will return to factory defaults.

## Printing EEG

You can print the currently displayed EEG view.

1. Select the EEG parameter window.
2. Select **EEG** tab > **View**.
3. Select **Numerical** or **CSA**.
4. Select **Print Page**.

## Stopping the EEG measurement

1. Disconnect the electrodes.

## EEG practicalities

### EEG measurement description

The EEG signal is continuously measured from up to four channels. This supports the international 10-20 system.

Measurement can be referential or bipolar. On the signal, a spectral analysis is performed using Fast Fourier Transform (FFT). The result is a spectrum, which indicates what frequencies are present in the EEG signal. EEG is traditionally divided into four frequency bands: delta, theta, alpha and beta.

In addition to the continuous EEG measurement, it is also possible to measure the response of the brain to external auditory stimulation by measuring evoked potentials, EP. When measuring auditory evoked potentials, AEP, auditory stimuli are delivered to the patient's ears by earphones or headphones, and the resulting signal is measured from above the cortex. During auditory evoked potential measurement, EEG is also simultaneously measured from the same electrodes. Frontal muscular activity is also assessed by electromyography, EMG, from one of the EEG channels.

### EEG frequency bands

To characterize the spectral content of the signal, the following parameters are calculated:

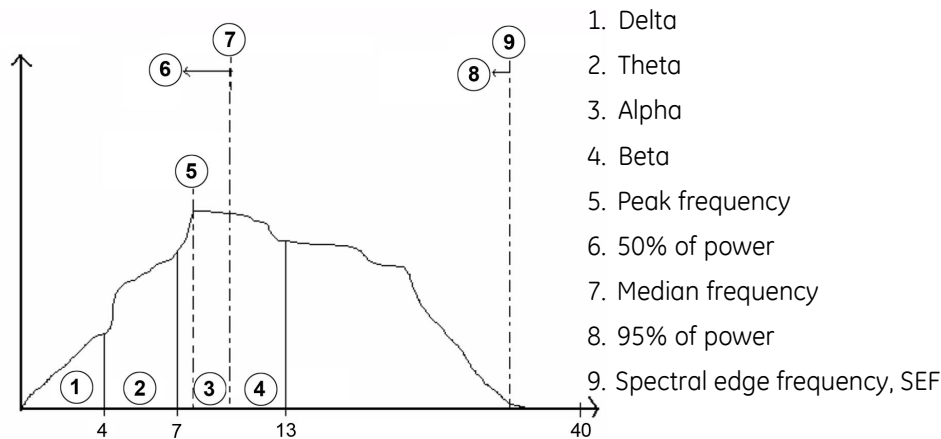

$$\text{Delta\%} = \frac{\text{Power in delta range}}{\text{Total power}} \times 100\%$$

Parameters:

- Spectral edge frequency, SEF: The frequency below which nearly all of the power is present.
- Median frequency, MF: Divides the spectrum in half: 50% of the power is below and 50% above this frequency.
- Frequency band ratios (Delta%, Theta%, Alpha%, Beta%) define what portion of the power is in a certain frequency band. For example, Delta% = power in delta band / Total power. The spectrum is displayed graphically as a single, continuously updating curve, or compressed spectral array (CSA), where spectra are stacked one on top of the other to form a trend display.

- Burst suppression pattern is also detected, and burst suppression ratio (BSR) - the ratio of suppressed EEG in a time period of 60 seconds - is calculated.
- Amplitude (Amp.) of EEG is calculated as a root mean square (RMS) value in microvolts.

## Compressed spectral array (CSA)

The spectrum is displayed graphically as a single, continuously updating curve, or compressed spectral array, CSA, where spectra are stacked one on top of the other to form a trend display. EEG split screen displays the compressed spectral array of all the monitored channels on the left hand side of the screen.

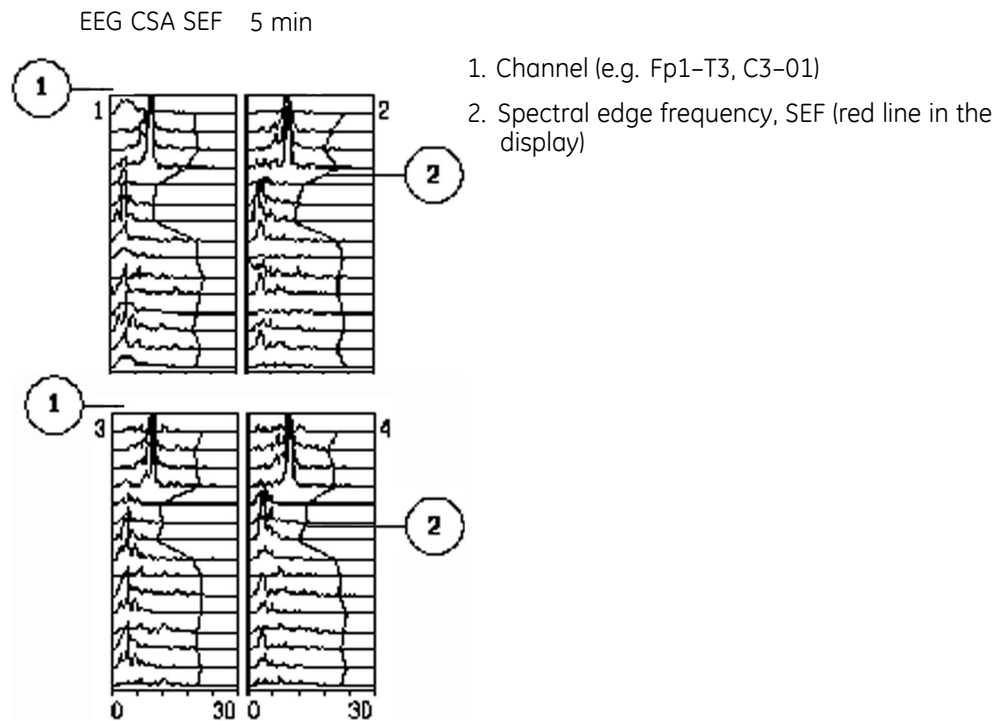

## How to interpret the EEG values

To evaluate certain EEG results, for example to distinguish epilepsy from other conditions, it is necessary to assess these findings together with other symptoms, including unconsciousness.

EEG findings are usually non-specific, and consequently they indicate a malfunction but do not reveal the reason for it.

Distinguishable characteristics to look for are:

- Frequency and amplitude
- Rhythm location and specific waveforms
- Artifact
- Reactivity

## Normal EEG frequencies

EEG frequencies look basically the same in all areas. They are symmetrical. However, in normal EEG the alpha waves are predominant on parietal areas.

Frequencies	Appearance
Delta (< 4 Hz)	In children; in adults with deep sleep
Theta (4 to 8 Hz)	Light sleep, early childhood
Alpha (8 to 13 Hz)	Adults, awake with eyes closed
Beta (> 13 Hz)	High activity or drugs

## Abnormal EEG characteristics

Distinguishable characteristics to look for are:

- Asymmetrical EEG between the left and the right hemisphere
- Burst suppression
- Suppression and low amplitude
- Delta activity
- Epileptic spikes

## EEG reactivity

Existing reactivity in the EEG is a sign of healthy brain activity. Accordingly, reduced reactivity may indicate a disorder in the brain activity, which requires action.

## Examples of typical EEG patterns

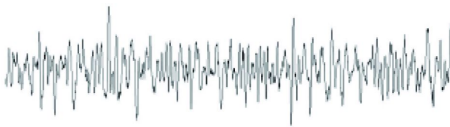
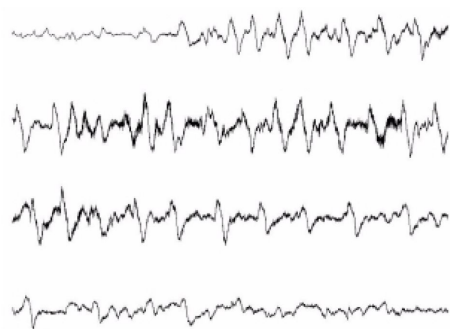
<ul style="list-style-type: none"> <li>• Pathologically slowed rhythms:</li> </ul>	
<ul style="list-style-type: none"> <li>• Seizure activity:</li> </ul>	

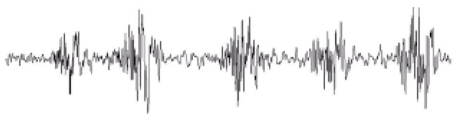
<ul style="list-style-type: none"> <li>• Periodic patterns: Distinct waveforms repeating with regular intervals (from 0.5 to several seconds). Periodic patterns that are characterized by sharp waves or spikes are known as epileptiform.</li> </ul>	
<ul style="list-style-type: none"> <li>• Burst suppression: High amplitude EEG patterns with intervening low amplitude activity. The duration may vary from &lt;0.5 seconds to several seconds.</li> </ul>	

## Technical artifact and EEG

To decrease technical artifact, the electrode-to skin-impedance should be low and electrode wires short. Wrapping the electrode wires together or adjusting ground electrodes may also help.

### Typical EEG recordings with electrical interference

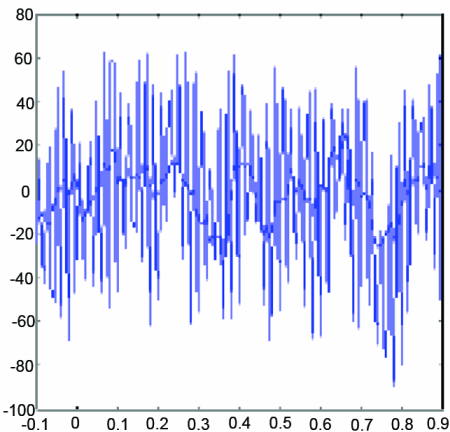
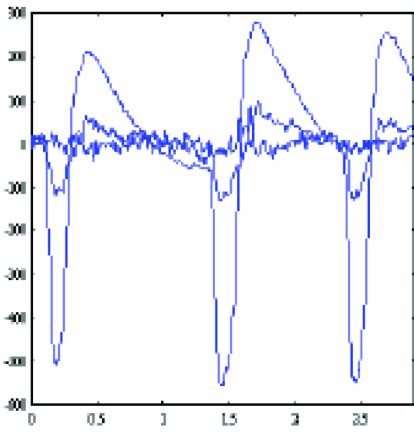
<ul style="list-style-type: none"> <li>• Electrical currents (AC): These are a common source of interference. Try using different low-pass or notch filters to eliminate them.</li> </ul>	
<ul style="list-style-type: none"> <li>• Eye movements: Patient eye movements cause typical patterns in the EEG waveform.</li> </ul>	

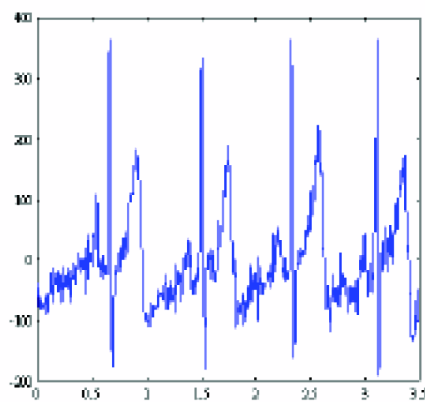
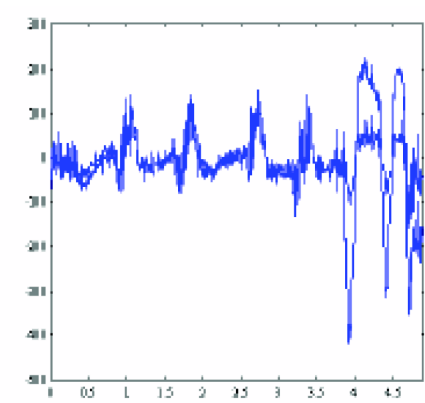
<ul style="list-style-type: none"> <li>• ECG: Cardiac electrical activity can affect the EEG waveform.</li> </ul>	 <p>The graph shows an EEG waveform with a y-axis ranging from -200 to 400 and an x-axis from 0 to 3.5. The signal is characterized by regular, sharp, high-amplitude peaks that occur at approximately 0.8, 1.5, 2.2, and 3.0 seconds, which are characteristic of cardiac electrical activity (ECG) interfering with the EEG signal.</p>
<ul style="list-style-type: none"> <li>• EMG: Activation of frontal muscles can cause high frequency interference in the EEG.</li> </ul>	 <p>The graph shows an EEG waveform with a y-axis ranging from -50 to 300 and an x-axis from 0 to 4.5. The signal is characterized by high-frequency, irregular bursts of activity, particularly between 3.5 and 4.5 seconds, which are characteristic of EMG (muscle activity) interfering with the EEG signal.</p>

## EEG troubleshooting

Problem	Solution
<p>What can I do if the signal looks noisy and there is a message indicating artifact?</p>	<p>Electrodes are poorly connected, or electrical interference is coupling to electrode cables.</p> <ul style="list-style-type: none"> <li>• Check that the electrodes are properly connected and not dried out.</li> <li>• Check the electrodes' contact with skin.</li> <li>• Perform electrode impedance check.</li> <li>• Calm the patient since frontal muscle activity can cause artifact</li> <li>• Remove sources of external electrical noise (for example, some lamps) from the vicinity of the patient's head.</li> <li>• ECG may cause artifact; change electrode positioning.</li> <li>• Check that there are not two identical measurement modules in the system.</li> </ul>
<p>Why are all EEG waveforms not drawn even if electrodes and cables are OK?</p>	<p>The number of channels in the montage is smaller than the number of channels connected to the patient.</p>

Problem	Solution
	<ul style="list-style-type: none"> <li>• Check the number of channels.</li> </ul> <p>The screen configuration may not include the EEG parameter window.</p> <ul style="list-style-type: none"> <li>• Check the monitor setup.</li> </ul>
Why are the numeric values replaced by ---?	<p>The patient has high muscle activity in the head area, or noise from some interfering equipment is coupling to electrode cables.</p> <ul style="list-style-type: none"> <li>• Relax the patient and remove the source of noise.</li> </ul>
Why do the electrode impedances show --- and there is a message prompting to check the ground electrode?	<p>The ground electrode is poorly connected to the patient, or its cable is not connected to the headbox.</p> <ul style="list-style-type: none"> <li>• Check the electrode and cable.</li> </ul> <p>If the impedance of the electrode is too high, the measurement fails even if the electrode is properly attached.</p> <ul style="list-style-type: none"> <li>• Use better electrodes or prepare the skin better.</li> </ul>
Why are there some baseline fluctuations?	<p>For instance, sweating may cause variations in the electrode impedance.</p> <ul style="list-style-type: none"> <li>• In case the fluctuation is disturbing, prepare the skin and replace the electrode.</li> </ul>

## Measuring auditory evoked potentials (AEP)

### Preparing the patient for AEP measurement

1. Prepare the patient and electrodes as you would for EEG measurement.
2. Connect the leadset and electrodes.
3. Connect earphones to the headbox and place them on the patient's ear/s.

**NOTE**

Make sure that the earphones do not press the patient's head in any position (for example, when the patient is lying on one side).

**NOTE**

Use only GE Healthcare supplied headphones/earphones. In other headphones/earphones the sensitivity may vary causing too high an intensity, which may damage the ear, or too low an intensity, which may cause a poor response.

## AEP montage

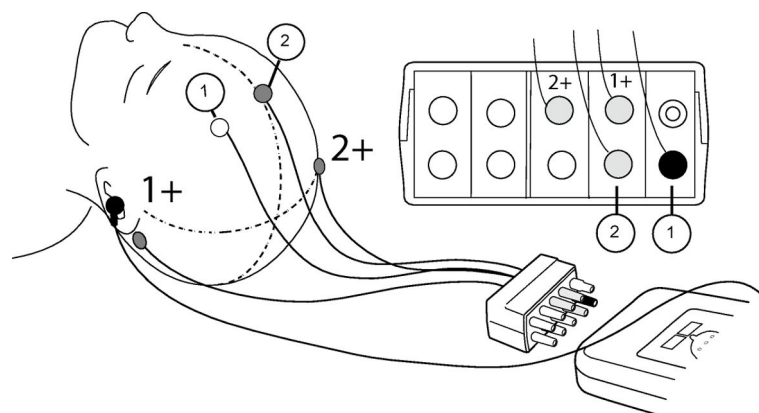

1. ground
2. reference

Montage	Settings	Electrodes
1. A1 – Fz 2. A2 – Fz Ground	Two channels, reference (Fz)	Four adhesive electrodes

## Using the AEP measurement

### Starting the AEP measurement

Press the **EP Start/Stop** key on the headbox or module, or:

1. Select the EEG parameter window.
2. Select the **AEP** tab > **View**.
3. Select **Start AEP**.

### Selecting the AEP channels

1. Select the EEG parameter window.
2. Select the **AEP** tab > **Setup**.
3. Select the number of channels from the **AEP Channels** list.

### Selecting the number of AEP responses

You can select the number of responses that will be averaged.

1. Select the EEG parameter window.
2. Select the **AEP** tab > **Setup**.
3. Select the number of responses from the **Responses** list.

### Selecting the AEP stimulus frequency

You can select how often the stimulus is given.



1. Select the EEG parameter window.
2. Select the **AEP** tab > **Setup**.
3. Select a value from the **Stimulus Frequency** list.

## Selecting the AEP stimulus intensity

You can select the volume of the clicks.

1. Select the EEG parameter window.
2. Select the **AEP** tab > **Setup**.
3. Select a value from the **Stimulus Intensity** list.

### NOTE

The decibel scale over the hearing threshold is only indicative because a complete audiologic calibration is not possible with the stimulus type used. The stimulus intensity has been calibrated according to peak equivalent sound pressure levels, and 10 dB on the scale corresponds to 50 dB peak equivalent sound pressure level.

## Selecting the AEP sweep length

You can select the length of the recorded and displayed waveform, and of the AEP split screen and AEP view.

1. Select the EEG parameter window.
2. Select the **AEP** tab > **Setup**.
3. Select a value from the **Sweep Length** list.

## Selecting the AEP filter

You can select the cut-off frequency of the high pass filter.

1. Select the EEG parameter window.
2. Select the **AEP** tab > **Setup**.
3. Select a value from the **Filter** list.

## Selecting the AEP cycle

You can select a manual, continuous or frequently repeated AEP measurement.

1. Select the EEG parameter window.
2. Select the **AEP** tab > **View**.
3. Select a value from the **Cycle** list.

## Selecting the AEP size

1. Select the EEG parameter window.
2. Select the **AEP** tab > **View**.
3. Select a value from the **EP Size** list.

## Saving AEP responses

You can set two markers per channel on the AEP waveforms, and save them for later reference. The monitor calculates and saves the latency at these points and the amplitude between them. You can save up to six auditory evoked potentials. These six can also be the same response with different cursor positions.

1. Select the EEG parameter window.
2. Select the **AEP** tab > **Save**.
3. Select **Channel 1** > **Lat1**.
4. Move the marker line to a suitable point.
5. Repeat steps 3 to 4 for **Lat2**, and then for **Channel 2** > **Lat1** and **Lat2**.
6. Select **Save Response**.

**NOTE** After six responses have been saved, the next saved response will overwrite the second response in the monitor memory.

## Selecting a reference AEP

You can select a saved auditory evoked potential as a reference that will be displayed simultaneously with the real time auditory evoked potential.

1. Select the EEG parameter window.
2. Select the **AEP** tab > **View**.
3. Select a reference AEP from the **Reference EP** list.

## Erasing an AEP reference

**NOTE** This selection is not available if you have not saved any references.

1. Select the EEG parameter window.
2. Select the **AEP** tab > **View**.
3. Select the reference to be erased from the **Erase EP** list.

## Printing an AEP report

**NOTE** You can only print saved AEP's.

1. Select **Monitor Setup** > **Printing**.
2. Select **Reports** > **Individual Reports** > **AEP**.

## Stopping the AEP measurement

Press the **EP Start/Stop** key on the headbox or module, or:

1. Select the EEG parameter window.
2. Select the **AEP** tab > **View**.
3. Select **Stop AEP**.

## AEP practicalities

### AEP measurement description

Evoked potentials (EP) are responses of the central nervous system to external stimulation. Common evoked potentials are the auditory evoked potentials (AEP), somatosensory evoked potentials (SSEP), and visual evoked potentials (VEP).

Evoked potentials are measured by stimulation and estimating the response. The evoked potentials are largely affected by the same things as the EEG. Integrity of neural pathways brings the information to the cortex. Examples of deficits in the pathways are slower, smaller responses (lower amplitudes, longer latencies).

Auditory evoked potentials (AEP) are transient responses to an auditory stimulus, which is usually given through headphones. AEPs reflect the function of the auditory pathway. To create a distinguishable response, a large amount of responses are averaged and the results are displayed as a waveform.

During AEP monitoring, the AEP electrodes are also used for EEG monitoring. The AEP measurement can be started manually, repeated automatically after set intervals, or the measurement can be continuous with moving averaging.

### Main peak categories (AEP)

Latencies and amplitudes of particular peaks are important information. Latency is the time to the peak, and amplitude is the height of the peak. Typically in anesthesia, for example, cortical latencies grow longer as anesthesia starts to take effect in the brain. Three main groups of peaks can be distinguished, and they can be correlated to anatomical structures.

- Brainstem AEP (BAEP)
  - with latencies shorter than 10 ms
  - cochlea, acoustic nerve, brainstem
- Middle latency AEP (MLAEP)
  - with latencies from 10 ms to 100 ms
  - primary auditory cortex (temporal lobe)
- Long latency AEP (LLAEP)
  - with latencies from 100 ms to 1000 ms
  - frontal cortex

**NOTE** LLAEP display is not supported in the monitor.

### Examples of typical AEP patterns

AEP 1 ms to 1000 ms with anatomical sites and labeling:

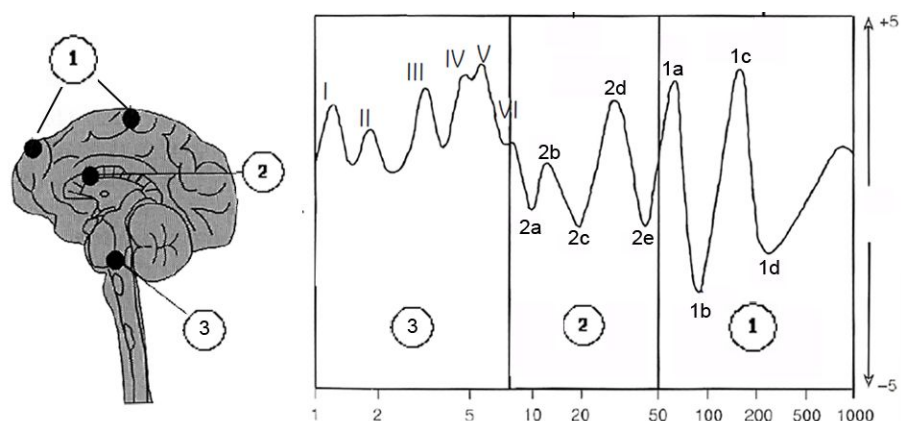

1. Frontal cortex and association areas; late cortical response
  - 1a = P1
  - 1b = N1
  - 1c = P2
  - 1d = N2
2. Medial geniculate and primary auditory cortex; early cortical response
  - 2a = No
  - 2b = Po
  - 2c = Na
  - 2d = Pa
  - 2e = Nb
3. Acoustic nerve and brain stem; brain stem response

## AEP troubleshooting

Problem	Solution
Why are there no clicks to be heard from the earphones/headphones?	The connector is not in place. <ul style="list-style-type: none"> <li>• Check that the plug is firmly pushed into the appropriate connector in the headbox.</li> </ul>
What if all or most of the EP epochs are rejected?	The signal has too much noise or artifact in the EP measurement band, for instance coupled 50/60 Hz may not be seen in the EEG waveform because of filtering. <ul style="list-style-type: none"> <li>• Check that the electrode impedances are below 5 kOhm, and that the impedances of a same channel are close to each other. If this does not help, try to remove sources of noise.</li> </ul>

# Bispectral index

## BIS compatibility

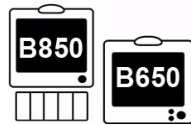

All features of this measurement are available for both monitors.

For detailed information regarding module, monitor, and accessory compatibility, see the supplemental information manual.

## BIS safety precautions

### BIS warnings

- |                |                                                                                                                                                                                                                                                                                                                                                                                                                                                                                                                                    |
|----------------|------------------------------------------------------------------------------------------------------------------------------------------------------------------------------------------------------------------------------------------------------------------------------------------------------------------------------------------------------------------------------------------------------------------------------------------------------------------------------------------------------------------------------------|
| <b>WARNING</b> | — DEFIBRILLATOR PRECAUTIONS — Patient signal inputs labeled with the CF and BF symbols with paddles are protected against damage resulting from defibrillation voltages. To ensure proper defibrillator protection, use only the recommended cables and leadwires.                                                                                                                                                                                                                                                                 |
| <b>WARNING</b> | Make sure that the electrodes, sensor and connectors do not touch any electrically conductive material, including earth.                                                                                                                                                                                                                                                                                                                                                                                                           |
| <b>WARNING</b> | When using an electrosurgery unit, note that the measurement cables do not incorporate means to protect against burns in case of a defective ESU return electrode. To avoid burns at the monitor measurement sites, ensure the following: <ul style="list-style-type: none"> <li>• Proper contact of the ESU return electrode to the patient.</li> <li>• ESU return electrode near the operating area.</li> <li>• Measurement electrodes, leadwires and probes far from the surgical site and the ESU return electrode.</li> </ul> |
| <b>WARNING</b> | Do not autoclave the signal processing unit (BISx) or the digital signal converter (DSC). Do not open it for any reason.                                                                                                                                                                                                                                                                                                                                                                                                           |
| <b>WARNING</b> | The sensor must not be located between defibrillator pads when a defibrillator is used on a patient connected to BIS devices.                                                                                                                                                                                                                                                                                                                                                                                                      |

- WARNING** This monitor uses a component modular device in deriving the Bispectral index (BIS) purchased from Covidien. It is important to recognize this index is derived using solely that company's proprietary technology. It is recommended that clinicians have reviewed applicable information on its utility and/or risks in published articles and literature/web site information from Covidien ([www.covidien.com](http://www.covidien.com)) or contact that company itself if they have clinical-based BIS questions relating to this module portion of the GE monitor. Failure to do so could potentially result in incorrect administration of anesthetic agents and/or other potential complications of anesthesia or sedation. We recommend that clinicians also review the following practice advisory (that includes a section on BIS monitoring): The American Society of Anesthesiologists, Practice Advisory for Intraoperative Awareness and Brain Function Monitoring (Anesthesiology 2006; 104:847-64). Clinicians are also recommended to maintain current knowledge of government regulatory, practice or research information on BIS and related topics.
- WARNING** Misinterpretation of BIS can result in incorrect administration of anesthetic agents and/or other potential complications of anesthesia or sedation.

## BIS cautions

- CAUTION** Due to elevated surface temperature, do not place the BIS device in prolonged direct contact with the patient's skin, as it may cause discomfort.
- CAUTION** The BIS measurement based on measuring the EEG signal is inherently very sensitive. Radiated electromagnetic fields may cause erroneous measurements at various frequencies. Do not use electrical radiating equipment close to the BISx or DSC. Details regarding radiated field strengths are given in the technical specifications.
- CAUTION** Automatic sensor check may need to be disabled if the 1 nA 128 Hz impedance check signal interferes with other equipment, such as EEG module with evoked potentials measurement.
- CAUTION** The BIS module has been designed to operate with a disposable BIS sensor. Only use recommended sensors.
- CAUTION** Do not use the BIS sensor if the sensor gel is dry. To avoid dryout, do not open the pack until you are ready to use the sensor.
- CAUTION** Check the sensor expiration date on the sensor package. Do not use expired sensors.
- CAUTION** If skin rash or any unusual symptom develops, discontinue the BIS measurement and remove the sensor.

**CAUTION**

When connecting or disconnecting BIS, take care not to touch the exposed contacts of either connector. Damage due to electrostatic discharge may result to the equipment.

## BIS indications for use

The BIS module is intended for use by personnel trained in its proper use. It is intended for use on adult and pediatric patients within a hospital or medical facility providing patient care to monitor the state of the brain by data acquisition of EEG signals. The Bispectral index (BIS), a processed EEG variable, and one component of the BIS module, may be used in adults as an aid in monitoring the effects of certain anesthetic agents. The Bispectral index is a complex technology, intended for use only as an adjunct to clinical judgment and training. In addition, the clinical utility, risk/benefit, and application of BIS have not undergone full evaluation in the pediatric population.

## BIS measurement limitations

- This measurement is not available in the NICU software package.
- E-modules used for this measurement are not suitable for use with neonatal patients.
- BIS is a complex monitoring technology intended for use only as an adjunct to clinical judgment and training. Clinical judgment should always be used when interpreting BIS in conjunction with other available clinical signs. Reliance on BIS alone for intraoperative anesthetic management is not recommended.
- BIS values should be interpreted cautiously with certain anesthetic combinations, such as those relying primarily on either ketamine or nitrous oxide/narcotics to produce unconsciousness.
- External radiating devices may disturb the measurement.
- Poor signal quality may lead to inappropriate BIS values.
- Artifact may lead to inappropriate BIS values. Potential artifact may be caused by unusual or excessive electrical interference or high EMG activity like shivering, muscle activity or rigidity, sustained eye movements, head and body motion. Also, improper sensor placement and poor skin contact (high impedance) may cause artifact and interfere with the measurement.
- Due to limited clinical experience in the following applications, the BIS value should be interpreted cautiously in patients with known neurological disorders and those taking psychoactive medications.

## BIS points to note

- Make sure that the sensor connectors of the patient interface cable are not in contact with fluids.
- BIS sensors are disposable, for single patient use only, and not made with natural rubber latex.
- Check the sensor expiration date on the sensor package.
- Do not use a sensor for more than 24 hours.
- Use only Covidien BIS sensors.

## BIS measurement setup

### BIS equipment to patient connection

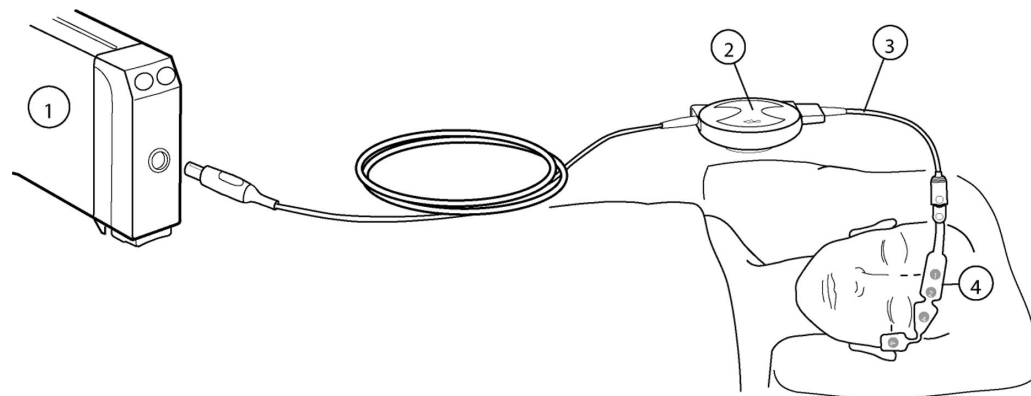

1. Module with BIS measurement capability, E-BIS
2. Digital Signal Processing Unit, BISx
3. Patient Interface Cable, PIC Plus
4. BIS sensor

### BIS module keys

There are two keys on the module:

	Opens or closes the BIS menu on the screen.
	Starts the manual sensor check.

### Preparing the patient for BIS measurement

1. Connect the digital signal processing unit (BISx) cable to the module.
2. Connect the patient interface cable to the BISx.
3. Secure the BISx to a convenient location, preferably close to the patient's head.
4. Clean the application site with alcohol and let dry.
5. Place the BIS sensor on the patient; see sensor package for instructions.
6. Connect the sensor to the patient interface cable.
7. Observe the results of the automatic sensor check in the parameter window.
8. The measurement starts automatically after the sensor has passed the check.

### Checking the BIS measurement

1. Check that the sensor/electrode passes the sensor/electrode check when you are starting to monitor a new patient.



## BIS measurement on the monitor screen

- Suppression ratio (SR) number indicates the percentage of suppressed (flatline) EEG detected over the last 63 seconds
- Bar graphs:
  - Signal Quality Index (SQI): the quality of the EEG signal. NOTE: When the SQI is in the range 15% to 50% (low), the BIS number is displayed in gray
  - Electromyograph (EMG): the absolute power in the 70 Hz to 110 Hz frequency band

## Using the BIS measurement

### Selecting the BIS waveform size

This setting determines the maximum drawing scale for BIS waveforms.

1. Press the  module key or select the BIS parameter window.
2. Select the **Setup** tab.
3. Select a value from the **Scale  $\mu$ V** list.

### Selecting the EEG sweep speed

This setting determines the drawing speed for the EEG waveform.

1. Press the  module key or select the BIS parameter window.
2. Select the **Setup** tab.
3. Select a value from the **EEG Sweep Speed** list.

The smaller the value, the slower the sweep speed.

**NOTE** This setting is available in BIS, EEG and Entropy setups. Regardless of where you change it, it will affect all three parameters.

### Selecting the BIS smoothing rate

Smoothing rate affects the appearance of the BIS trend and the BIS value. It determines the amount of artifact-free data that is required for calculating the BIS value.

1. Press the  module key or select the BIS parameter window.
2. Select the **Setup** tab.
3. Select a value from the **Smoothing Rate** list. The bigger the value, the “smoother” the trend.

### Setting BIS filters

With BIS filters you can filter out disturbances from the EEG signal and improve the signal quality.

1. Press the  module key or select the BIS parameter window.

2. Select the **Setup** tab.
3. Select **Filters**. Set the filter option according to your needs: set the filters on by selecting the check box, or set them off by deselecting the check box.

## Setting BIS alarm limits

You can set the alarm limits according to your needs.

1. Press the  module key or select the BIS parameter window.
2. Select the **Alarms** tab.

### NOTE

If the feature is not active, the alarm limits are greyed out. Select **Alarm On** to set the alarms.

3. Set the high and low alarm limits with the arrows.

## Using the automatic BIS sensor check

1. Press the  module key or select the BIS parameter window.
2. Select the **Setup** tab.
3. Select **Sensor Check > Automatic**.

## Using the manual BIS sensor check

Whenever required, you can perform the sensor check manually. Press the  module key, or:

1. Select the BIS parameter window.
2. Select the **Setup** tab.
3. Select **Check Sensor**.
4. Observe the results on the screen.

The measurement continues automatically after the sensor has passed the check.

## Testing the BISx

In case the measurement does not work and checking the cables and sensors does not help, make sure that the BISx functions properly.

1. Press the  module key or select the BIS parameter window
2. Select the **Setup** tab.
3. Select **Test DSC**.
4. Observe the results on the screen.

After the test is completed, the result shown is **PASS** or **FAIL**.

## Stopping the BIS measurement

1. Remove the BIS sensor from the patient.
2. Disconnect the sensor from the patient interface cable.
3. Discard the sensor.

## How to interpret the BIS values

The Bispectral Index is an absolute value, so baseline information about the patient is not required for BIS monitoring. The following table lists the BIS values and their significance.

BIS value	Clinical endpoint	Comments
100	Awake	Patient responds to normal voice
80	Light/moderate sedation	Patient responds to loud commands or mild prodding/shaking
40 to 60	General anesthesia	Patient has low probability of explicit recall and is unresponsive to verbal stimulus
20	Deep hypnotic state	EEG suppression, or burst suppression as it is sometimes referred to, is an easily recognizable EEG pattern characterized by bursts of activity of varying shape alternating with episodes of flatline activity.
0	Isoelectric EEG	No brain activity detected

This chart reflects a general association between clinical state and BIS values. Ranges are based on results from a multi-center study of the BIS involving the administration of specific anesthetic agents. BIS values and ranges assume that the EEG is free of artifact that can affect its performance.

Titration of anesthetics to BIS ranges should be dependent upon the individual goals for hypnotic state that have been established for each patient. These goals and associated BIS ranges may vary over time and in the context of patient status and treatment plans.

Low BIS values (below 40) may indicate overdosing of hypnotic medication, and high BIS (over 60 to 65) may indicate too low concentrations of the drug.

## BIS troubleshooting

Problem	Solution
Measurement does not start	<ul style="list-style-type: none"> <li>• Check sensor attachment to the patient and the sensor placement.</li> <li>• Check the sensor's contact with skin.</li> <li>• Check the sensor type.</li> <li>• Check all cable connections.</li> <li>• Check the digital signal processing unit.</li> </ul>
BIS signal is poor	<ul style="list-style-type: none"> <li>• Check the sensor's contact with skin.</li> <li>• Check the sensor.</li> <li>• Ensure that the digital signal processing unit is not close to any electrical radiating equipment.</li> </ul>

## Bispectral index

Problem	Solution
What happens during the BISx self test?	<p>The BISx self test tests the digital signal acquisition and conversion functions. The test reports pass/fail status, noise, high-pass blocked, high-pass normal and gain values.</p> <ul style="list-style-type: none"><li>• If any of the self tests fail, contact authorized service personnel.</li></ul>
What if the sensor does not pass the sensor check?	<ul style="list-style-type: none"><li>• The sensor check may fail for the following reasons:<ul style="list-style-type: none"><li>▪ Impedance too high.</li><li>▪ Incorrect sensor application.</li><li>▪ Poor sensor connection.</li><li>▪ Defective patient interface cable or sensor.</li></ul></li></ul> <p>To correct the situation:</p> <ul style="list-style-type: none"><li>• Recheck the sensor.</li><li>• Reapply the sensor according to instructions.</li><li>• Check sensor connection.</li><li>• Replace patient interface cable or sensor.</li></ul>

# Laboratory data

## About laboratory values

The **Laboratory Data** menu shows many laboratory values and you can manually enter values needed for oxygenation and hemodynamic calculations (**pH**, **PCO₂**, **PO₂**, **HCO₃⁻**, **BE**, **TCO₂**, **SO₂**, **FiO₂** and **Hb**). The laboratory data menu also displays a set of other laboratory data obtained through an interfaced device.

The message **Lab data available** is displayed when laboratory data is available from an interfaced device. The interfaced values are updated automatically to the value table. You can perform temperature correction to interfaced or obtained **pH**, **PCO₂**, or **PO₂** values, but other editing is prevented.

When entering laboratory values manually, make sure that the units are the same as the ones on the screen. If they are not, convert the values before entering them. You can also change the units on the screen. They are changed through **Monitor Setup > Default Setup > Care Unit Settings > Units > Laboratory Values** and the settings are password protected.

For more information, see the supplemental information manual.

## Viewing laboratory data

You can view the most recently saved laboratory data.

1. Select **Data & Pages**.
2. Select **Laboratory Data**.
3. You can now see the values on the **View** tab.

In addition to the available laboratory values, you can see the following information:

- **Sampling:** The date and time of sampling, and how long ago the sampling took place.
- **Patient's temperature:** This is shown if it is available.
- **Temperature correction:** **No**, **Yes**, or **Laboratory**.
- **Sample site:** **Arterial**, **Venous**, or **Other**.

## Selecting the blood sample site for laboratory values

1. Select **Data & Pages**.
2. Select the **Enter Data** tab.

3. Select **Arterial**, **Venous**, or **Other** from the **Sample Site** list.

Note that selecting **Arterial** or **Venous** affects the labels of **pH**, **PO2**, **PCO2**, and **SO2**:

- **Arterial** changes the labels to **pHa**, **PaCO2**, **PaCO2**, and **SaO2**.
- **Venous** changes the labels to **pHv**, **PvO2**, **PvCO2**, and **SvO2**.

## Selecting the blood sample time for laboratory values

1. Select **Data & Pages**.
2. Select **Laboratory Data**.
3. Select the **Enter Data** tab.
4. Set the **Sample Time** with arrows.
5. Select **Save**.

## Temperature correction

In the laboratory, blood gas values are measured and calibrated at +37 °C (+99 °F). The **pH**, **PCO2**, and **PO2** values may need to be corrected to the actual patient temperature because an increase or decrease in temperature changes the amount of dissolved blood gas molecules and pH.

While the **Enter Data** tab of the **Laboratory Values** menu shows both the corrected and uncorrected values, the **View** tab shows either the corrected or uncorrected values depending on the **Temperature Correction** selection.

Formulas used to calculate the values when temperature correction is enabled are given in the supplemental information manual.

## Selecting the type of temperature correction

1. Select **Data & Pages**.
2. Select **Laboratory Data**.
3. Select the **Enter Data** tab.
4. Select an option from the **Temperature Correction** list:
  - **Laboratory**: Temperature correction has been done in the laboratory and the values have already been corrected to patient temperature. The entered **pH**, **PCO2**, and **PO2** values are stored without adjustment and they are shown in the **Temp corrected** column.
  - **Yes**: The monitor will perform correction calculations. Select a temperature source from the **Temperature Source** list and the monitor recalculates the entered blood gas values corrected to patient temperature. Both the corrected and uncorrected values are shown.
  - **No**: No temperature correction is needed or performed. The entered blood gas values are shown as such.

## Entering or loading laboratory values

1. Select **Data & Pages**.
2. Select **Laboratory Data**.
3. Select the **Enter Data** tab.
4. Adjust the values with arrow selectors.  
When you set a value, it first changes to its default value. Interfaced values are shown with gray selectors and cannot be adjusted.
5. Ensure that you have set the **Sample Time** or it has been sent by the interfaced device. If not, set it now.
6. Select **Save** to confirm the entered values.  
If you do not select **Save**, new data is lost when you exit the menu.

## Printing laboratory values

You can print the most recently saved laboratory data.

1. Select **Data & Pages**.
2. Select **Laboratory Data**.
3. Select the **View** tab.
4. Select **Print**.

## Laboratory data



# 25

## Calculations

### About calculations

Calculations are used to derive calculated hemodynamic, oxygenation, and ventilation values from actual measurements. Calculations also provide trending for the calculated values.

Saved laboratory data can be used as input data for oxygenation and ventilation calculations. The monitor marks the temperature corrected values in the oxygenation and ventilation calculations with the letter c.

### Viewing calculation values

A list of displayed input and calculated parameters is given in the supplemental information manual.

1. Select **Data & Pages**.
2. Select **Calculations**.
3. Select **Hemo**, **Oxy**, or **Vent** tab.
4. Select **View**.

Parameter data is now displayed in two columns: **Input Parameters** and **Calculated Parameters**.

### Source data for calculations

Several types of data (blood gas, laboratory) are required to complete a calculation. Data can be entered automatically using a network interface, or manually by the clinician.

Source data means that the time of its collection will be used as the basis for collecting additional data from the trends. The monitor uses the C.O. measurement as source data for hemodynamic calculations. However, C.O. or CCO and/or their indexed values that are older than 15 minutes are not used as source data. Other input values (for example, HR, PA Mean, CVP, Art Mean) used in the calculation are chosen from the same time the sample is drawn or the cardiac output is measured. For oxygenation calculations the monitor uses laboratory data as source data.

In oxygenation calculations, you can select any available arterial laboratory data samples or any C.O. measurement (if no laboratory data but multiple C.O. values are available) from the current patient case to be used as source data.

In ventilation calculations, you can select any arterial laboratory data samples from the current patient case to be used as source data.

## Selecting source data for oxygenation calculations

1. Select **Data & Pages**.
2. Select **Calculations**.
3. Select the **Oxy** tab.
4. Select **Edit Input**.
5. Select the desired sample with corresponding time and date from the **Select Lab Data** list.

## Selecting source data for ventilation calculations

1. Select **Data & Pages**.
2. Select **Calculations**.
3. Select the **Vent** tab.
4. Select **Edit Input**.
5. Select the desired sample with corresponding time and date from the **Select Lab Data** list.

## Estimated values in oxygenation calculations

In normal circumstances, about 3% of the total arterial oxygen content is dissolved in the blood and 97% is hemoglobin bound. When no SaO₂ laboratory result is saved in the **Laboratory Data** menu, the measured SpO₂ value is used to estimate the clinically relevant SaO₂ value. Also, the measured EtCO₂ value is used to estimate the PaCO₂ value.

The monitor marks the estimated values by adding the letter e to the SaO₂ and PaCO₂ values in the **Calculations > Oxy > Trend** and **Calculations > Oxy > View**.

## Estimated values in hemodynamic calculations

You can select different sources for the PCWP. If you select **LAP mean** or **PA**, the **PCWP** value in **Hemo > Trend** will be marked as an estimated value with the letter e. Instead, the **Hemo > Edit Input** and **Hemo > View** show the actual selected label.

## Selecting the PCWP source

1. Select **Data & Pages**.
2. Select **Calculations**.
3. Select the **Hemo** tab.
4. Select **Edit Input**.
5. Select the source from the **PCWP Source** list:
  - **PCWP**
  - **LAP mean**
  - **PA dia**

## Indexing parameters for hemodynamic and oxygenation calculations

Indexed values are calculated only if the patient's BSA (body surface area) value is available at the time when the calculations take place.

1. Select **Data & Pages**.
2. Select **Hemo** or **Oxy** tab.
3. Select **View**.
4. Select the **Indexed** check box at the lower part of the view.

Those parameters that can be indexed are now displayed as indexed, and indexed values are calculated.

## Editing calculation input values

1. Select **Data & Pages**.
2. Select **Calculations**.
3. Select **Hemo**, **Oxy**, or **Vent** tab.
4. Select **Edit Input**.
5. Enter or edit the parameter values with the arrows of the **Value** column.
6. To perform the actual calculation and save the values, select the **View** tab > **Save**.  
If you select **Previous Menu** before saving the values, they are lost.

## Saving calculation values

1. Select **Data & Pages**.
2. Select **Calculations**.
3. Select **Hemo**, **Oxy**, or **Vent** tab.
4. Select **View**.
5. Select **Save** to save the input parameter values and calculated parameter values to the corresponding calculation trends.

**Save** is disabled if neither the input parameters nor the calculated parameters have values available, or if the displayed values have already been saved.

## Viewing saved calculations

The monitor displays indexed values if the **Indexed** check box has been selected in the calculations **Trend** menu, and **Save** has been selected to add the calculations to the trends. The indexed values are calculated and trended only if the patient's BSA (body surface area) value is available at the time when the calculations are performed.

1. Select **Data & Pages**.
2. Select **Calculations**.
3. Select **Hemo**, **Oxy**, or **Vent** tab.

4. Select **Trend**.

To navigate between the pages of the **Trend** menu, use the left or right arrow keys in the lower part of the menu.

## Printing hemodynamic, oxygenation, or ventilation calculations

You must save the calculations before you can print them. If they have not been saved, the **Print** selection is disabled.

1. Select **Data & Pages**.
2. Select **Calculations**.
3. Select **Hemo**, **Oxy**, or **Vent** tab.
4. Select **View**.
5. Select **Print**.

## Printing all calculation trends

You can print all calculation trends at once.

1. Select **Data & Pages**.
2. Select **Calculations**.
3. Select **Hemo**, **Oxy**, or **Vent** tab.
4. Select **Trend**.
5. Select **Print**.

# 26

## Drug calculations

### About drug calculations

The intravenous administration of medications is a common practice. Many drugs are titrated based on the patient's physiologic response to the medication or according to the patient's weight. Accuracy and safety are always important in drug therapy, and precise control of drug administration is essential. The drug calculator provides an accurate and safe method of determining drug dosage.

An order for a medication is either written by the physician or is a standing protocol in the unit based on the patient's condition. The order will specify the drug and the dose to be administered. The clinician and/or pharmacy will mix the drug in solution, and then determine how fast to administer the drug in order to deliver the proper drug dosage.

Neonates present a different approach to drug administration because the amount of fluid to be administered is vital. Usually, the drug dosage is ordered and the flow rate in ml/h or cc/hr is prescribed. The clinician must determine the amount of drug to place in the solution in order to meet the rate/dose combination.

In other cases, the physician may order a drug dosage to be infused over a period of time. The amount of drug in solution may or may not be specified. In this situation, the clinician must determine the rate that is needed to infuse the proper drug dosage over the period of time ordered.

Still another situation occurs in cases where drugs are administered to resuscitate the patient, and then the dose is determined after the response. The clinician considers the solution volumes and drug quantities and the rate of the infusion to determine the dose that the patient is actually receiving.

The drug calculator can be used in all of these situations. In addition, it also provides a titration table that can be used as the dosages are increased or decreased, based on the patient's physiologic response. The titration table displays drug dosage information that can be used to help the clinician determine the dosing effects of intravenous pump setting and infusion rate changes.

## Calculations menu description

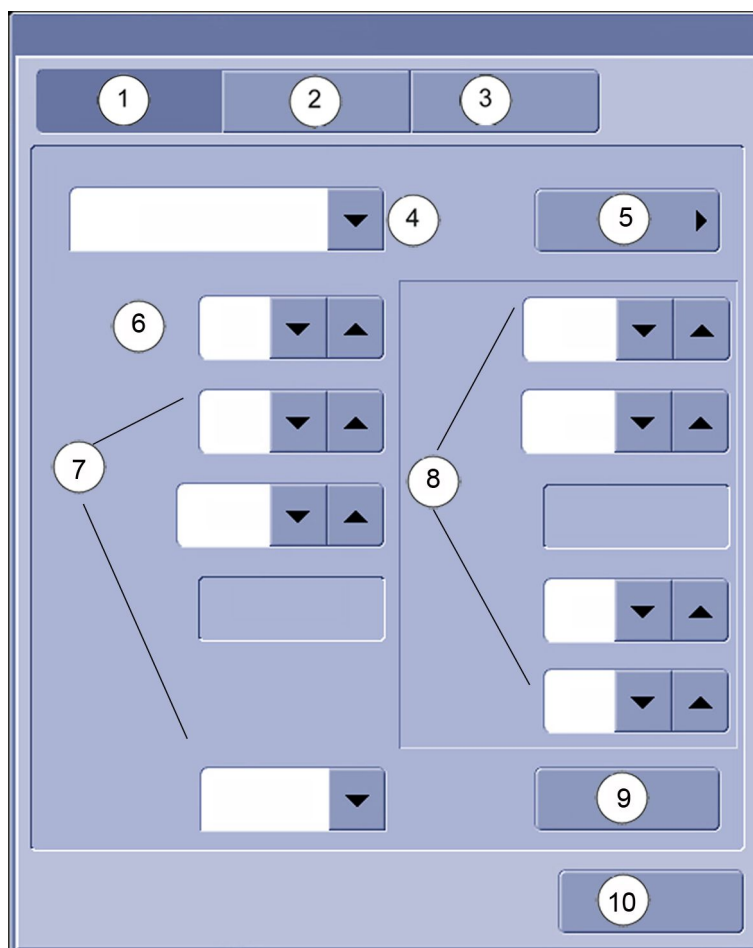

1. **Calculator** tab: Allows you to set various drug settings like **Drug Amount**, **Dose**, etc.
2. **Titration Table** tab: Allows you to set the **Dose Increment** for a drug you select from the **Drug Name** list. From this tab you can also print a titration table listing the doses and infusion rates for the selected drug.
3. **Resuscitation Medications** tab: This tab is only visible in the NICU software package. It allows you to calculate, view, and print resuscitation medication information for neonates.
4. **Drug Name** list: The contents of this list are configured through the **Care Unit Settings** and they are password protected.
5. **Additional Drug**: Allows you to enter a new drug name to the **Drug Name** list temporarily. Any drugs added will only be on the list until the patient is discharged/case is ended.
6. **Patient's Weight**: Allows you to enter the patient's weight if the selected **Dose Unit** requires it.
7. Selections for entering drug specification information from the drug order. **Concentration** is automatically calculated.
8. Selections for entering drug dose administration information.

9. **Print:** Allows you to print the calculated drug dose and infusion rate.
10. **Previous Menu:** Allows you to return to the previous menu.

## Drug calculator

### Calculating drug doses

The drug calculator allows you to calculate and print the doses and infusion rates for intravenous medications.

1. Select **Data & Pages**.
2. Select **Drug Calculations**.
3. Select the **Calculator** tab.
4. Select a drug from the **Drug Name** list.

If necessary, you can also add a new drug to the list through selections available when selecting **Additional Drug**.

5. If the patient's weight was not entered at the time of admission and the selected **Dose Unit** requires it, set the **Patient's Weight**.

#### NOTE

Changing the weight in the drug calculator menu does not change the weight in the patient demographics. Changing the patient's weight in the **Calculator, Titration Table**, or **Resuscitation Medications** tab will change the displayed value in all of them.

6. Set the **Solution Volume**.
7. Set the **Drug Amount**.  
**Concentration** level is automatically calculated.
8. Set the **Dose Unit** if appropriate.
9. Set the **Dose**.

The **Infusion Rate ml/h**, **Infusion Time h**, and **Infusion Time min** are automatically calculated.

### Adding a new drug name

You can add a new drug name and calculate drug doses for that drug. The drug name is deleted when the patient is discharged from the monitor.

1. Select **Data & Pages**.
2. Select **Drug Calculations**.
3. Select the **Calculator** tab.
4. Select **Additional Drug**.
5. Enter the drug name with the on-screen keyboard.

The name can contain a maximum of 20 characters and it is case-sensitive (for example, Insulin and insulin would be two different drug names).

6. Select **Add**.

The drug name is now added to the **Drug Name** list and can be selected as any other drug until the patient is discharged.

## Printing drug dose calculations

You can print the calculated drug dose and infusion rate.

1. Select **Data & Pages**.
2. Select **Drug Calculations**.
3. Select the **Calculator** tab.
4. Select **Print**.
5. You can stop printing by selecting **Stop Printing** or **Cancel Printing**.

## Titration table

### Calculating drug titrations

The titration table calculator allows you to calculate and print titration information for a selected drug.

1. Select **Data & Pages**.
2. Select **Drug Calculations**.
3. Select the **Titration Table** tab.
4. Select the **Drug Name**.
5. If the patient weight was not entered during admission and the selected **Dose Unit** requires it, set the **Patient's Weight**.

**NOTE**

Changing the weight in the drug calculator menu does not change the weight in the patient demographics. Changing the patient's weight in the **Calculator, Titration Table**, or **Resuscitation Medications** tab will change the displayed value in all of them.

6. If needed, change the **Dose Increment**.

The titration table now shows the doses (50 rows) in the **Dose** column, and corresponding infusion rates in the **Infusion Rate (ml/h)** column.

### Printing the titration table

1. Select **Data & Pages**.
2. Select **Drug Calculations**.
3. Select the **Titration Table** tab.
4. Select the **Print**.
5. You can stop printing by selecting **Stop Printing** or **Cancel Printing**.



# Resuscitation medications

## Calculating resuscitation medication doses

**NOTE** NICU software package only.

1. Select **Data & Pages**.
2. Select **Drug Calculations**.
3. Select the **Resuscitation Medications** tab.
4. If the patient weight was not entered during admission, set the **Patient's Weight**.

**NOTE** Changing the weight in the drug calculator menu does not change the weight in the patient demographics. Changing the patient's weight in the **Calculator, Titration Table**, or **Resuscitation Medications** tab will change the displayed value in all of them.

5. Select **Confirm**.  
The monitor will not calculate the dose values until the patient's weight value has been confirmed.

## Printing resuscitation medication doses

You can print a list of resuscitation medications and their concentration level, delivery method, and dose value.

1. Select **Data & Pages**.
2. Select **Drug Calculations**.
3. Select the **Resuscitation Medications** tab.
4. Select **Print**.
5. You can stop printing by selecting **Stop Printing** or **Stop Printing**.

## Drug calculations

# Trends

## Monitor and module compatibility

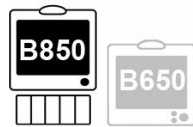

TRAM and Tram-Rac modules with the B850 only.

## Trend views

Different trend views display various types of trend data: graphic, numeric, event, snapshot, ST snapshot, and gas consumption data. All views have default parameter content. Trend views can be configured through **Monitor Setup > Default Setup > Profile Settings > Trends & Snapshot**. These selections are password protected.

For more information, see the supplemental information manual.

When entering the trends menu after ending a case/discharging the patient or when the monitor has been powered down for longer than 15 minutes, the displayed menu and trend view are the configured graphic or numeric ones. Displayed trend data and views are updated if there is an active case on the monitor or at least one vital sign parameter is connected. This applies to all trend, event and snapshot views.

You can also split the normal screen page so that the left side of the screen continuously shows graphic minitrends beside waveforms.

The numeric trends include a predefined set of parameters. The graphic trend selections include all parameters that can be used. If you are viewing trends for parameters for which you do not have a license, trend labels are shown, but no new data is collected. Therefore, no data is shown in the trend view or printouts. You can view data that was loaded from previous cases where the parameters were available.

## System warning safety messages

The following warning safety messages apply to this monitoring system.

## Graphic trends

### Viewing graphic trends





Graphic trends contain 24 or 72 hours of trend data depending on the trend license. They contain four trend pages, each having up to six fields, with different parameters

already preconfigured in the defaults. Five fields can be displayed and six fields printed. The top of each page can be configured to show the highest priority realtime waveform.

1. Select **Trends**.
2. Select **Graphic** from the **View** list.
  - To see more parameters, select tabs **1** to **4**.
  - To see numeric values of a certain time, move the cursor to that point of time. The numeric values are displayed next to the cursor.

## Graphic trend symbols

In printouts the graphic presentation formats are replaced by symbols. The following are some examples of these.

	CO ₂
	SpO ₂
	Art (sys/dia/mean): The gap shows the blood pressure mean value.
	NIBP (sys/dia/mean): The gap shows the blood pressure mean value.

## Changing the time scale of graphic trends

The time scale setting is dependent on the cursor time. When the cursor position is more than 30 minutes from the current time, the **Time Scale** list does not show the 20 minute option. With the high-resolution trends license enabled, the 20 minute option is visible even if the cursor is as far as 1 hour from the current time. High-resolution trends contain 24 hours of trend data. This means that when the cursor position is more than 24 hours from the current time, the **Time Scale** list does not show the 2 minute, 4 minute, and 20 minute options.

1. Select **Trends**.
2. Select **Graphic** from the **View** list.

3. Select a time value from the **Time Scale** list.

The available selections depend on the license in use:

- Basic settings for all software packages are 20 minutes, 1 h, 2 h, 4 h, 6 h, 8 h, 10 h, 12 h, and 24 h.
- The 72 h license provides the basic settings and additionally 36 h, 48 h, and 72 h selections.
- The high-resolution license provides basic settings and additionally 2 minute and 4 minute selections.

## Changing the graphic trend scales

1. Select **Trends**.
2. Select **Graphic** from the **View** list.
3. Select **Trend Scales**.
4. Select the **General**, **IP/NIBP**, **Cardiac Output**, or **Temp** tab.
5. Set the trend scales for required parameters.

## Printing currently viewed graphic trends

1. Select **Trends**.
2. Select **Graphic** from the **View** list.
3. Select **Print Page**.
4. You can stop printing by selecting **Cancel Printing**.

## Printing all graphic trend data

1. Select **Monitor Setup > Printing**.
2. Select **Reports > Trends**.
3. Select **Print**.
4. You can stop printing by selecting **Cancel Printing**.

## Graphic trend resolution and the high-resolution license

The graphic trend resolution depends on the time scale of the trend. Graphic trends are updated once a minute when the time scale is 1 hour or more. For the 20 minute scale, the update rate is 10 seconds.

High-resolution trends is a licensed graphic trend option that provides an increased resolution of 2 seconds for the 2, 4, and 20 minute scales. The high resolution graphic trend is updated on user request. This trend also contains compressed CO₂ and impedance respiration waveforms (10 Hz) as well as beat-to-beat ECG heart rate and mean arterial pressure MAP (6 Hz).

High-resolution trend data is not saved over power down situations. This means that data in the 2, 4, and 20 minute time scales is erased.

High-resolution trend data is neither sent nor loaded to/from the network (central station) or acquisition modules (PDM, TRAM).

## Numeric trends

### Viewing numeric trends

Numeric trends contain nine pages with 24 or 72 hours of trend data depending on the trend license. The top of the view shows the highest priority realtime waveform. The lowest row, **Mark**, shows snapshot event numbers. If more than one snapshot has been created in a one-minute period, only the last snapshot event number is shown. You cannot configure the layout of the **Numeric** trend view.

1. Select **Trends**.
2. Select **Numeric** from the **View** list.
  - To see other parameters, select their tabs in the **Numeric** trend view.
  - To see more numeric trend data, use the cursor to scroll the data in horizontal direction.

### Changing the time interval of numeric trends

Numeric trends display values according to the selected time interval. Numeric trends are updated with averaged measurement data once a minute independent of the selected time scale.

1. Select **Trends**.
2. Select **Numeric** from the **View** list.
3. Select a value from the **Time Interval** list.

For example, a 5 minute interval will show data for every 5 minutes, and a 30 minute interval will show data for every 30 minutes. The data is displayed in columns on the screen. NIBP, PCWP, cardiac output, NMT, and manual SPV measurements will always add one column independent of the **Time Interval** setting.

### Printing numeric trends

1. Select **Trends**.
2. Select **Numeric** from the **View** list.
3. Select **Print Page** (Recorder).
4. You can stop printing by selecting **Stop Printing**.

Depending on what has been configured, either the data currently on screen or all data will be printed. This configuration is done through **Monitor Setup > Default Setup > Care Unit Settings > Printer > Numeric Trends Printing** and it is password protected.

For more information, see the supplemental information manual.

## Invasive pressure trends

The following invasive pressure trend data is collected:

- TRAM or PDM and Dual BP, BP, BP/Dual temperature single-parameter Tram-Rac modules:
  - Systolic, diastolic, and mean pressure data for **Art**, **ABP**, **Fem**, **PA**, and **UAC**.
  - Mean pressure data for **FemV**, **CVP**, **LAP**, **RAP**, **ICP**, **P1** to **P8**, **RVP**, and **UVC**.

- E-modules:
  - Systolic, diastolic, and mean pressure for all labels except **UAC** and **UVC**.

The invasive pressure trends will only be stored for those channels that have been zeroed.

## Heart rate (HR) trends

Only the measured values from the primary heart rate or pulse rate source are trended to the HR graphic and numeric trends. Pulse rate sources that can be selected are the monitored and zeroed invasive pressure (IP) channels labeled with **Art**, **ABP**, and **Fem** (and **UAC** in NICU software package only), and the SpO₂ parameter.

## Gas consumption

### NOTE

This feature is only available through the Unity Network Interface Device (ID) v6 or later.

## Viewing gas consumption data

The **Machine Gas Cons.** view shows the amount of Air, O₂, N₂O, and anesthetic agents used by an interfaced anesthesia machine during the ongoing patient case.

If the values for Air, O₂, or N₂O exceed the range limit, the text **>32767 l** appears instead of the value. For the anesthetic agents, the text is **>999 ml**.

1. Select **Trends**.
2. Select **Machine Gas Cons.** from the **View** list.

## Printing gas consumption data

You must print the report before discharging the patient/ending the case.

1. Select **Trends**.
2. Select **Machine Gas Cons.** from the **View** list.
3. Select **Print Page** to print the currently viewed page.

## Minitrend split screen

### Minitrend view

You can split the normal screen page so that the left side of the screen continuously shows graphic minitrends beside waveforms. Minitrend is a license providing components for minitrend and minitrend length. The high-resolution license additionally provides compressed waveforms for CO₂ and respiration.

Minitrends follow graphic trend scale settings. Use the same scale for waveforms and trends. IP minitrends are an exception: they follow the IP waveform scales and not the IP trend scales.

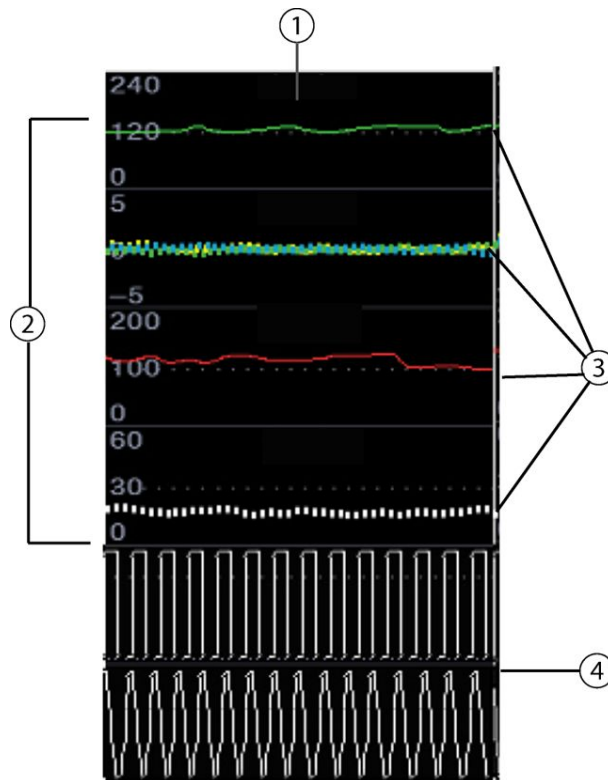

1. Indication of the selected minitrend length (for example, 1 minute)
2. Trend scales
3. Graphic minitrends; visualization according to the parameter
4. Compressed waveform

You can also have minitrends on other pages than the normal screen. This setting is configured through **Monitor Setup > Default Setup > Profile Settings > Pages** and it is password protected.

For more information, see the supplemental information manual.

## Selecting the minitrend to screen

1. Select **Monitor Setup > Screen Setup**.
2. B850 with Double Video license: Select **Screen 1** or **Screen 2** tab.
3. Select the **Split Screen** tab.
4. Select **Minitrend** from the **Show** list.

## Modifying the minitrend length

You can select the minitrend length from a selection varying from 1 minute to 120 minutes. The 1 minute and 2 minute selections are available with the high-resolution license only.

1. Select **Monitor Setup > Screen Setup**.
2. B850 with the Double Video license: Select **Screen 1** or **Screen 2** tab.
3. Select **Split Screen** tab.



4. Select a value from the **Minitrend Length** list.
  - The 1 minute and 2 minute minitrends (high-resolution license) are updated every 2 seconds.
  - The 5 minute and 10 minute minitrends are updated every 10 seconds.
  - Other lengths are updated once a minute.

## Selecting high-resolution contents to minitrend

If the high-resolution license is enabled and the **10 min wide** is 1 minute normal or 2 minutes wide, you can select CO₂ and impedance respiration (10Hz) **Compressed Waveform** minitrends or **Resp Rate** minitrends.

1. Select **Monitor Setup > Screen Setup**.
2. B850 with Double Video license: Select **Screen 1** or **Screen 2** tab.
3. Select the **Split Screen** tab.
4. Select **Minitrend** from the **Show** list.
  - a. Select **Resp Rate** from the **CO₂ Minitrend** or from the **Imp. Resp Minitrend** list.
  - b. Select **Compressed Waveform** from the **CO₂ Minitrend** or from the **Imp. Resp Minitrend** list.

## Removing minitrend from the screen

1. Select **Monitor Setup > Screen Setup**.
2. B850 with the Double Video license: Select **Screen 1** or **Screen 2** tab.
3. Select the **Split Screen** tab.
4. Select the **None** from the **Show** list.

## Time change during a patient case

### CAUTION

System time changes will result in time differences between stored and realtime data.

Time adjustment is allowed during a patient case if the monitor is configured to the CARESCAPE Network. When the time is adjusted, the monitor shifts the timestamps of continuous trend data and of discrete data, except NIBP and wedge measurements.

After time adjustment continuous and discrete data cannot be compared to each other because their timestamps no longer match.

## Trends

# Snapshots and events

## Description of snapshots

A snapshot is a set of measured data saved from a certain moment of time. Snapshots can contain waveform clips and graphic trends. You can take up to 400 snapshots depending on the data load.

The duration of the stored snapshot may not contain the entire duration of the physiological event that triggered it. If the snapshot was triggered by the monitor, there will be about 11.5 seconds of waveform data displayed in the waveform box. If the snapshot was converted from a telemetry transmitter or PDM alarm history, there will be 10 seconds of waveform data displayed.

## Snapshot configuration

Snapshots are configured through **Profile Settings > Trends & Snapshot > Snapshot** and these settings are password protected.

For more information, see the supplemental information manual.

## Manually created snapshots

You can create a snapshot manually by selecting **Freeze/Snapshot**. The monitor saves the image of preconfigured waveforms or trends at that moment in time.

When a snapshot is taken manually, it is automatically numbered. A **Mark xxx** message is shown in the message field (xxx = the sequence number of the snapshot). This number also appears in the numeric trend view.

## Creating automatic snapshots

You can select alarms that will automatically create a snapshot independent of their alarm priority.

1. Select **Trends**.
2. Select **Snapshot** from the **View** list.
3. Select **Snapshot Setup**.

4. Select which alarms will automatically create a snapshot:
  - **Tachy/Brady** (PDM, E-modules) or **HR High/Low** (TRAM, telemetry).
  - **ST High/Low**: An ST snapshot will be created for **ST Ant high, ST Ant low, ST Inf high, ST Inf low, ST Lat high, ST Lat low**, ST xxx high and ST xxx low (xxx = lead).
  - **PVC**
  - **SVC**
  - **Art/Fem/ABP/UAC High/Low**
  - **SpO2 High/Low**
  - **Apnea**

You can also define automatic snapshot creation for each arrhythmia alarm separately through the **ECG** menu.

## Viewing snapshots

1. Select **Trends**.
2. Select **Snapshot** from the **View** list.

In the upper right hand corner of the **Snapshot** view, you can see the time the snapshot was created. Five fields can be displayed on the snapshot page, and six fields can be printed.

The lowest field in the **Snapshot** view shows the event time scale and indication box. The snapshots are shown with color coded vertical lines. A yellow line indicates the chosen snapshot and its exact time is shown in digits.

Event indicators are drawn in the time indication box as vertical lines according to the time of the event and shown in the following colors:

- White: a snapshot event and during standby. Event indicators will be displayed for standby periods at one minute intervals (time scale other than 2 minutes) or two second intervals (time scale 2 minutes).
- Red: a high priority alarm event
- Yellow: a medium priority alarm event

You can select snapshots either by using the arrows in the scroll bar, or with the Trim Knob by selecting the scroll bar and then turning the Trim Knob. When the cursor is scrolled in the event time scale and indication box of the **Snapshot** view, it moves between the snapshot indicators only and skips the ST snapshot indicators. Note that when viewing the ST snapshots, the cursor moves between the ST snapshots only.

When you select the **Snapshot** view and there are snapshots, the snapshot closest to the trend cursor's time is displayed. The snapshot cursor's time is set to the time of that snapshot.

## Changing the snapshot time scale

1. Select **Trends**.
2. Select **Snapshot** from the **Trend** list.
3. Select a time value from the **Time Scale** list.

## Changing snapshot trend scales

1. Select **Trends**.
2. Select **Snapshot** from the **View** list.
3. Select **Trend Scales**.
4. Select a parameter tab: **General**, **IP/NIBP**, **Cardiac Output**, or **Temp**.
5. Select scales for parameters as required.

## Printing snapshot pages

1. Select **Trends**.
2. Select **Snapshot** from the **View** list.
3. Select **Print Page**.
4. You can stop printing by selecting **Cancel Printing**.

**NOTE** The iCentral can also start snapshot printing, see the iCentral and iCentral Client User's Reference Manual for details.

## Selecting snapshots to print automatically

You can select certain snapshots to print automatically.

1. Select **Trends**.
2. Select **Snapshot** from the **View** list.
3. Select **Snapshot Setup**.
4. Select the snapshots to print:
  - **No**: No snapshots print automatically.
  - **Alarms**: Snapshots created by alarms print automatically.
  - **All**: All snapshots print automatically.

## Selecting spirometry loops to print with snapshots

1. Select **Trends**.
2. Select **Snapshot** from the **View** list.
3. Select **Snapshot Setup**.
4. Select **Print Loop** > **Yes** or **No**.

## Erasing snapshots and trends

Snapshots and trends are erased when you end a case / discharge a patient, when the monitor has been off for more than 15 minutes, or automatically after 24 hours or 72 hours depending on the license. If the monitor has been off for less than 15 minutes, the snapshots are stored and remain unchanged.

Erased snapshots cannot be recovered. The memory is automatically checked every time a snapshot is created. When the memory is too full, the message **Snapshot memory full. Oldest snapshot erased.** is displayed in the message field for five seconds. If the contents of the snapshot have been changed, a new snapshot may

need more memory than the previous ones. Therefore, more than one snapshot may have to be erased.

To erase snapshots, you must discharge the patient/end a case. Note that this will not erase just the snapshots but also all other patient and trend data from the monitor and a connected PDM or TRAM, and will also return monitor settings to their defaults.

1. Select the patient information area on screen, or select **Data & Pages > Start / Reset Case** (OR and PACU software packages) or **Admit/Discharge** (other software packages).
2. Select **Patient > Discharge Patient**.
3. Select **Yes**.

## Snapshots and alarm history

### CAUTION

— MEASURING DATA STORED IN ALARM HISTORY — Waveform data is stored in the alarm history using compression technology that may not allow perfect reconstruction of the waveform data when subsequently viewed. Although differences occur relatively frequently and are usually very minor, users are urged to verify diagnostic waveform measurements with the waveform data from realtime graph strips.

When a PDM or telemetry transmitter is connected to the monitor, the saved alarm history and ST history will be transferred to the monitor. One snapshot is created for each alarm history.

The PDM or a telemetry transmitter alarm history has 10 seconds of waveform data from two or three ECG leads and the first arterial invasive pressure line. The snapshot will display waveforms only if the snapshot field configuration includes the same ECG waveforms and/or arterial invasive pressure channel. Otherwise, no waveform data is displayed.

A snapshot is sent to the CARESCAPE Network if it contains one of the following waveforms: ECG lead I, II, III, or Va, or any arterial invasive pressure.

## Snapshot transfer to PDM

Telemetry transmitters store snapshots independently. They are stored on the PDM when they are transferred by the monitor. Only snapshots created by arrhythmia alarms are transferred. Manual snapshots and snapshots triggered by SpO₂ high/low and arterial IP high/low alarms are not stored to the PDM.

## ST snapshots

### Creating ST snapshots manually

An ST snapshot displays QRS complexes.

1. Select **Monitor Setup > Parameter Setup**.
2. Select **ECG > ST**.
3. Select **Realtime View**.

4. Select **Save Reference**.

The monitor saves an image of preconfigured waveforms or trends. You can take up to 10 ST snapshots depending on the data load. If there is not enough free memory in the database to create the next ST snapshot without deleting old ST snapshots, the message **ST snapshot memory full. Oldest ST snapshot erased.** is displayed.

## Viewing ST snapshots

1. Select **Trends**.
2. Select **ST-Snapshot** from the **View** list.

On the upper right corner of the **ST-Snapshot** view, you can see the time the ST snapshot was created. The **ST-Snapshot** view displays 11 QRS complex windows. The bottom field shows the event time scale and indication box.

## Printing ST snapshots

1. Select **Trends**.
2. Select **ST-Snapshot** from the **View** list.
3. Select **Print Page**.
4. You can stop printing by selecting **Cancel Printing**.

## Erasing ST-snapshots

You cannot erase the initial reference complex.

1. Select the ST parameter window.
2. Select the reference to be erased in the **Erase Reference** list.

## Events

### Description of events

Events are timestamps that are shown in their own list. An event is created automatically upon an alarm. An event records the time of and reason for its creation. Some events may also record a snapshot. Manually created events contain only the time and a manually added reason for the event. You cannot configure the **Event** trend pages.

### Automatic events

An event is created automatically from:

- Medium and high priority physiological or technical alarms.
- Low priority alarms that have a snapshot.
- Manually created snapshots or ST snapshots.

An event is also created automatically when alarm history is transferred from PDM, TRAM, or telemetry transmitter to the monitor and corresponding snapshots are created at the monitor.

## Viewing events

The **Event** trend view shows event data on horizontal axis and time on vertical axis. The top of the view shows the highest priority realtime waveform and the bottom of the view shows a sample waveform if an event has a snapshot.

1. Select **Trends**.
2. Select **Event** from the **View** list.
  - The **Priority** column shows an alarm priority symbol for events created automatically from an alarm.
  - The **Event** column shows the reason the event was created for. If the event was created automatically, the alarm message is shown. If the event was created manually, a possible manually added text is shown. If there is a manual annotation added to the event, this text is shown in quotation marks with the prefix NOTE.
  - The **Snapshot** column shows a snapshot symbol if there is a snapshot attached to an event.

## Sorting events

You can select how the events are sorted: by **Time** with the newest event on top, or by **Priority** with the highest priority alarm on top in chronological order. Manually created events and snapshots have the lowest priority.

1. Select **Trends**.
2. Select **Event** from the **View** list.
3. Select **Time** or **Priority** from the **Sort by** list.

## Creating events manually

The manual creation of an event enables you to add a special situation to the **Event** trend view and to describe its reason in the desired way.

1. Select **Trends**.
2. Select **Event** from the **View** list.
3. Select **Create Event**.
4. Type the text in the **Event** field with the on-screen keyboard. Maximum number of characters is 50.
5. Select **Add** to add the event to the event list.

The time stamp of the event is the time you select **Add**.

## Annotating events

You can add an annotation to an existing event to describe the event in more detail.

1. Select **Trends**.
2. Select **Event** from the **View** list.
3. Select the desired event from the **Event** trend view.
4. Select **Annotate Event**.
5. Type the text in the **Annotation** field with the on-screen keyboard. The maximum number of characters is 50.



6. Select **Add** to add the annotation text to the event.

## Deleting events

1. Select **Trends**.
2. Select **Event** from the **View** list.
3. Select the desired event from the **Event** trend view.
4. Select **Delete Event**.

## Undeleting events

1. Select **Trends**.
2. Select **Event** from the **View** list.
3. Select the **Show Deleted** check box.
4. Select the deleted event you wish to undelete and select **Undelete Event**.

## Printing events

You can print alarms and user event in event history reports. Depending on the number of saved events, one or more pages are printed.

1. Select **Trends**.
2. Select **Event** from the **View** list.
3. Select **Print Page**.
4. You can stop printing by selecting **Cancel Printing**.

Snapshots and events

# Printing

## Printing options

Depending on the system configuration, the following printing capabilities are available:

- Printing to a recorder connected directly to one of the M-ports.
- Printing to a built-in recorder (B650).
- Printing to a remote recorder connected to another networked bedside monitor (except a B650) or a central station in the CARESCAPE Network.
- Printing to a bedside printer connected via the IX network interface. In this case the IX Network interface cannot be used for other network purposes.
- Printing to a network printer connected to an iCentral in the S/5 Network.
- Printing to a network printer connected to the IX Network.

You can print realtime waveforms (generated by a manual request or by an arrhythmia or non-arrhythmia alarm) and numeric trends to a recorder or a printer. In addition, you can print different types of reports to a printer.

## Laser printers

### WARNING

— EXCESSIVE LEAKAGE CURRENT — Laser printers are UL 60950/IEC 60950 certified equipment, which may not meet the leakage current requirements of patient care equipment. This equipment must not be located in the patient environment unless the medical system standard IEC 60601-1-1 is followed. Do not connect a laser printer to a multiple socket outlet supplying patient care equipment. The use of multiple socket outlet for a system will result in an enclosure leakage current equal to the sum of all the individual earth leakage currents of the system if there is an interruption of the multiple socket outlet protective earth conductor. Consult your local service representative before installing a laser printer.

### WARNING

— EXCESSIVE LEAKAGE CURRENT — A secondary display or printer that is a non-medical grade device and is used within the patient environment, must always be powered from an additional transformer providing at least basic isolation (isolating or separating transformer). Using without an isolating transformer could result in unacceptable enclosure leakage currents.



1. **Cancel Print** key: Press to cancel print request.

**NOTE**

This is only an example of a printer. In other models, the key may be located elsewhere.

A laser printer may be connected to the monitor via network, or to a central station on the network. A bedside printer may be directly connected to the monitor's network port with a crossover cable or via a network hub.

**NOTE**

A laser printer manages multiple laser printouts at a time by queuing them. If one printout is being processed and another is initiated for the same laser printer, the second printout will be queued and printed after the first one. An exception is continuous printing. If waveforms are being printed continuously (max. duration 5 minutes) and another printout is initiated for the same laser printer, continuous printing is stopped and the second printout is printed. After the second printout is finished, the continuous waveform printing is restarted.

**NOTE**

When a print job is canceled from the monitor, no more data is sent to the printer. However, the printer will finish printing all the data it had received before the stop/cancel request

## Recorders

**NOTE**

Recorders print on thermal paper. The data printed on thermal paper may be destroyed by exposure to light, heat, acids, PVC, and alcohol. Make a photocopy of the printout for your archives.

You can connect a recorder directly to the monitor (B850) or use the built-in recorder option locally (B650). You can also use a recorder over the network connected to a central station or connected to a remote monitor (other than B650).

## PRN 50-M recorder (B850 only)



1. Power on indicator: Illuminates when connected to power.
2. Paper out indicator: Illuminates when you need to replace the recorder paper.
3. **GRAPH STOP** key: Press to stop printing.
4. Power switch: Press to turn on or turn off the recorder.
5. Power connector: Connect the recorder's power cable.
6. ASYNC COMM port: Not used.
7. M-port connector: Connect to the CARESCAPE Monitor B850.

## XE-50 recorder (B650 only)

B650



1. Built-in recorder option

**NOTE**

Remote recording is only possible *from* the B650 to a GE monitor or a central station; remote recording is not possible *to* the B650.

## Printing device selections

### Changing printer

1. Select **Monitor Setup** > **Printing**.
2. Select the **Devices** tab.
3. Select **Setup**.

4. Select the printout type from the **Printout** list.

Note that the printing location (see step 5) for **Telemetry Waveforms** will only be sent to the telemetry when starting the combination monitoring mode with a non-admitted telemetry patient.

5. Select the location for the printout:

If you are printing to this location	Select this option
Local recorder XE-50 or PRN 50-M (connected directly to or built in the monitor). This selection is only available for <b>Telemetry Waveforms</b> if the PRN 50-M recorder is connected.	<b>Local</b>
Remote recorder or printer (a recorder in another monitor in the CARESCAPE network, or a recorder or a printer connected to a central station in the network).	<b>Remote</b>
Network printer (a printer in the IX Network or connected to an iCentral). This is always the print location for reports. This is not available if the printout type is <b>Telemetry Waveforms</b> .	<b>Network</b>

6. According to your location selection above:
  - a. If you selected **Network**: Select the print device from the **Network Device** list.
  - b. If you selected **Remote**: Choose the monitor or central station from the **Unit** list, and then select the print device from the **Remote Device** list.

**NOTE** You may assign one printout type to one print location only.

**NOTE** Changing the print location does not affect printing currently in progress.

## Checking the print status

You can view the assigned print locations for each type of printout and check the printer status for each print device.

1. Select **Monitor Setup > Printing**.
2. Select the **Devices** tab > **Status**.

## Printing waveforms

### Printing waveforms for an arrhythmia alarm

**NOTE** Automatic printing of waveforms is always initiated by an alarm.

1. Select **Alarm Setup** from the main menu.

2. Select the **Arrhythmia** tab.
3. Select **Print on Alarm** for the arrhythmias you would like to print.

**NOTE** For arrhythmia alarm waveform printing, the printing will continue until 20 seconds has passed from the clearance of the last active arrhythmia alarm (e.g., 10 seconds saved data, arrhythmia alarm duration + 20 seconds data).

## Printing waveforms for other than arrhythmia alarms

The following are the default settings for other than arrhythmia alarm waveform printouts:

- The print delay is 10 seconds.
- The print duration is 30 seconds.
- The waveform speed is 25mm/s.

Other than arrhythmia alarms that print are the high/low alarms for the following: HR, Art/ABP/Fem/UAC sys/dia/mean, SpO₂, and ST.

1. Select **Monitor Setup > Printing**.
2. Select the **Waveforms** tab.
3. Choose a value from the **Print on Alarm** list:
  - **No**: No alarm waveforms print during an alarm condition.
  - **High**: Alarm waveforms print during high priority alarm conditions only.
  - **All**: Alarm waveforms print during any alarm condition.

## Setting the print delay

**NOTE** Alarm waveforms (arrhythmia and non-arrhythmia) start by printing 10 seconds of the most recently saved data, regardless of the **Delay** setting.

1. Select **Monitor Setup > Printing**.
2. Select the **Waveforms** tab.
3. Select a value from the **Delay** list:
  - a. **0 s**: Manual waveform printing starts with real time data.
  - b. **10 s**: Manual waveform printing starts with 10 seconds of the most recently saved data first. After that, the real time data begins to print.

## Setting the print duration

**NOTE** Non-arrhythmia alarms print 30 seconds of waveforms regardless of the **Print Length** setting.

**NOTE** An arrhythmia alarm waveform continues to print up to 20 seconds after the arrhythmia resolves or a new arrhythmia has been identified. The length of the event shall determine the length of the printout.

1. Select **Monitor Setup > Printing**.
2. Select the **Waveforms** tab.

3. Choose a time value from the **Print Length** list: **10 s**, **30 s** or **Continuous**.

**NOTE** If you select **Continuous**, waveforms continue to print until you stop the printing.

## Setting the print speed

**NOTE** Alarm waveforms will print at 25 mm/s regardless of the **Paper Speed** setting.

To select the sweep speed for a laser printed report, or the actual paper speed of a recorder:

1. Select **Monitor Setup > Printing**.
2. Select the **Waveforms** tab.
3. Select a time value from the **Paper Speed** list.

## Selecting waveforms to print

1. Select **Monitor Setup > Printing**.
2. Select the **Waveforms** tab.
3. Choose the desired ECG lead/parameter for waveforms 1-4.

## Printing from the main display

1. Select **Print Waveforms**.

**NOTE** If print length has been configured for **Continuous**, you will be required to stop or cancel the print request.

## Printing from the waveforms window

1. Select **Monitor Setup > Printing**.
2. Select the **Waveforms** tab.
3. Select **Print Waveforms**.

## Stopping the waveform printing

### Stopping a waveform printout with PRN 50–M (B850 only)

1. Press the **GRAPH STOP** key on the recorder.

### Stopping a waveform printout from the main display

1. Select **Stop Printing**.

### Stopping a waveform printout from the waveforms window

1. Select **Monitor Setup > Printing**.
2. Select **Waveforms** tab.
3. Select **Stop Printing** or **Cancel Printing**.



## Printing trends

### Configuration of numeric trends for printing

Configuring the data printout type in the **Printer** menu requires a password. You need to configure the printer to print either currently viewed numeric trend data (**Data on Screen**) or all numeric trend data (**All Data**) relating to the currently viewed page.

**NOTE** For details, see the supplemental information manual.

### Automatic printing of events and snapshots

Event, snapshot and ST snapshot printouts can be printed automatically by an alarm.

**NOTE** iCentral can also start snapshot printing, see the iCentral and iCentral Client User's Reference Manual for details.

### Printing trends manually

**NOTE** Manual printing is possible only when the printing device is not processing another job at the same time.

1. Select **Trends**.
2. Select trend type from the **View** list: **Graphic, Numeric, Event, Snapshot, Machine Gas Cons.**, and **ST-Snapshot**.
3. Select desired **Time Scale**.

**NOTE** **Time Scale** is not selectable in the **Numeric, Event, and Machine Gas Cons.** views. You can, however, select the **Time Interval** for printing the **Numeric** trends.

4. Select **Print Page**.

## Printing reports

### Printing and patient discharge

Discharging a patient generates the automatic printing of care reports (ICU, ED, and NICU software packages), and cancels all other recording and laser printing.

### Configuring a trend report

**NOTE** Before printing a report, ensure that you have selected the proper settings.

1. Select **Monitor Setup > Printing**.
2. Select the **Reports** tab > **Trends**.
3. Select the desired print length.
4. Select the desired hour and minutes using the up and down arrows.
5. Select trend pages 1-4.

6. Select hours per page.

## Printing a trend report

**NOTE** Before printing a report, ensure that you have selected the proper settings.

1. Select **Monitor Setup > Printing**.
2. Select the **Reports** tab.
3. Select **Trends > Print**.

## Printing individual reports

1. Select **Monitor Setup > Printing**.
2. Select the **Reports** tab > **Individual Reports**.
3. Select the report type you wish to print: **QRS/ST**, **Loops**, **AEP**, **Calculation Trends**, and **Patient Information**.

## Care report printouts

**NOTE** For details, see the supplemental information manual.

**NOTE** Care reports are predefined in the default setup.

You can print care reports that include graphic trends printouts, calculation trends printouts, saved spirometry loops printouts, and/or AEP printouts.

## Printing care reports manually

1. Select **Monitor Setup > Printing**.
2. Select the **Reports** tab.
3. Select **Care Report > Print**.

## Automatic care report printouts

The automatic printing of care reports is possible only in the ICU, ED and NICU software packages, and it is initiated when a patient is discharged. An automatically initiated care report consists of a cover page and reports selected in the **Profile Settings > Care Report** menu. The care report setup allows you to select the content, duration, and resolution of the reports.

**NOTE** For details, see the supplemental information manual.

## Printing calculations

### Printing Hemo, Oxy, or Vent calculations

Before printing calculation printouts or calculation trends, you need to enter the calculation values in the **Edit Input** menu and save them in the **View** menu.

To print the currently viewed calculation page:

1. Select **Data & Pages > Calculations**.

2. Select **Hemo, Oxy** or **Vent**.
3. Select **View > Print**.

## Printing Hemo, Oxy, or Vent calculation trends

To print all calculation trends in the currently selected calculations menu:

1. Select **Data & Pages > Calculations**.
2. Select **Hemo, Oxy** or **Vent**.
3. Select **Trend > Print**.
4. To stop printing, select **Cancel Printing**.

## Printing drug calculations

### Printing drug calculator

1. Select **Data & Pages**.
2. Select **Drug Calculations**.
3. Select **Calculator > Print**.

### Printing titration table

1. Select **Data & Pages**.
2. Select **Drug Calculations**.
3. Select **Titration Table > Print**.

## Printing laboratory data and parameter printouts

### Printing laboratory data

**NOTE**

The **Laboratory Data** menu is accessible also through the **Calculations > Hemo, Oxy** and **Vent** menus.

1. Select **Data & Pages**.
2. Select **Laboratory Data**.
3. Select **View > Print**.

### Parameter printouts

You can print parameter printouts from the parameters' own menus. You can get printouts of:

- ECG waveforms
- 12SL
- ST trends
- QRS/ST

- C.O.
- Spirometry loops
- EEG
- Catheter insertion
- PA wedge reports
- Calculations

## Print header information

### Laser printer print header

You can print parameter printouts from the parameters' own menus. You can get printouts of:

- Patient name (displayed if configured in the care unit default settings)
- Second ID
- Medical record number
- Bed number
- Unit name (if the monitor is on the MC Network)
- Hospital name
- Date and time of the printout
- Current page/total number of pages (e.g., 1/12)
- Printout title (e.g., alarm, waveforms, and reports)
- Identification field for a patient identification sticker
- Notes field for manually written notes

### Recorder print header

- Patient name
- Second ID
- Medical record number
- Bed number
- Unit name
- Date and time of the printout
- Printout title

# 30

## Viewing other monitored patients

### About viewing other monitored patients

When the monitor is on the network, you can open a bed-to-bed view of other remote patient beds that are on the same network. You can choose to view a remote patient bed under an alarm condition, or simply view any available bed on your network.

The numeric values, up to six waveforms, alarms, and location information are displayed inside a separate bed-to-bed window. The bed-to-bed window is located on the left side of the display screen.

Function	Network features
View on alarm notification	CARESCAPE Network and S/5 Network: Monitor alarms for up to 40 beds.
View remote beds	CARESCAPE Network: View one bed from up to 1023 beds. S/5 Network: View one bed from up to 128 beds.

**NOTE** When using the B650 with WLAN connection, the maximum number of remote beds is ten.

Some settings related to remote alarm configuration are given through **Care Unit Settings > Alarms > Remote Alarms**, and they are password protected:

- Enabling or disabling audio pausing remotely for another monitor (**Allow Audio Pause: For Remote Bed**). Choices are **Yes** and **No**. CARESCAPE Network only.
- Selecting which remote locations are allowed to pause audio alarms on this monitor (**Allow Audio Pause: From Remote Location**). Choices are **Not Allowed**, **Central**, or **Central and Remote Beds**. CARESCAPE Network only.
- Selecting alarm priorities that can be paused remotely (**Allow Remote Pausing of**). Choices are: **Low Alarms**, **Low & Medium**, or **All Alarms**.
- Display of the remote patient name (**Show Remote Patient Name** check box).
- Use of the alarm light for a remote alarm (**Remote Alarm Light**). Choices are **On** or **Off**.
- Selecting the remote alarm tone (**Remote Alarm Tone**). Choices are **Off**, **Single**, **Repeat**, or **Local**.
- Enabling or disabling the restoring of the remote bed selections after discharge (select or deselect the **Restore after Discharge** check box for **Remote Bed Selections**).

For more information, see the supplemental information manual.

## Automatic view of remote beds in alarm

Automatic viewing of remote alarms is a licensed feature.

You can set the monitor to automatically notify you with an alarm message or with a bed-to-bed window when selected remote patient beds go into an alarm condition. All automatically viewable alarming beds display in order from the highest to lowest alarm priority and from the newest to oldest alarms.

You can configure how the monitor notifies you of a remote patient bed alarm condition, and which remote patient alarm priority levels you want notification of. You can do this for individual beds, or for all remote beds of a selected care unit at once.

### Selecting the alarm notification type

1. Select **Data & Pages**.
2. Select **Other Patients**.
3. Select the **Receive Alarms** tab.
4. Select a care unit from the **Unit** list.
5. Select a patient bed from the displayed list.
6. Select the type of alarm notification desired from the **Alarm Notification** list:

- **Off**: Remote alarm notification is turned off.

**NOTE**

All new monitors appear on the list automatically with the notification setting **Off** (default).

- **Message**: Remote alarm messages display in the alarm area. At any time, you can select a remote alarm message to open a bed-to-bed window and view the remote patient's data.
- **Auto View**: Bed-to-bed window opens immediately if no other procedure or setup window is currently open. Otherwise, a remote alarm message displays in the alarm message area. To open the bed-to-bed window and view the remote patient's data, close the currently open menu, or select the remote alarm message.
- **Auto View Always**: Immediately closes any open procedure or setup windows and opens a bed-to-bed window with the remote patient's data.

### Selecting the notifying alarm priority level

1. Select **Data & Pages**.
2. Select **Other Patients**.
3. Select the **Receive Alarms** tab.
4. Select a care unit from the **Unit** list.
5. Select a patient bed from the displayed list.

6. Select which alarm priority levels you want notification of:
  - **High**: Opens a bed-to-bed window for remote patients in a high alarm priority condition.
  - **High, Med**: Opens a bed-to-bed window for remote patients in a high or medium alarm priority condition.
  - **High, Med, Low**: Opens a bed-to-bed window for remote patients in a high, medium, or low alarm priority condition.

## Changing the settings for multiple beds

You can select a care unit and change all of the listed remote patient beds to a single notification setting and/or a single alarm priority setting. If there are more than 40 beds in the unit, the settings will be changed for the first 40 beds only.

1. Select **Data & Pages**.
2. Select **Other Patients**.
3. Select the **Receive Alarms** tab.
4. Select a care unit from the **Unit** list.
5. Select a setting from the **Change All Notifications** list:
  - **Off**: Remote alarm notification is turned off.
  - **Message**: Remote alarm messages display in the alarm area.
  - **Auto View**: Bed-to-bed window opens immediately if no other procedure or setup window is currently open. Otherwise, a remote alarm message displays in the alarm message area.
  - **Auto View Always**: Immediately closes any open procedure or setup windows and opens a bed-to-bed window.
6. Select a setting from the **Change All Priorities** list: **High**; **High, Med**; **High, Med, Low**.

## Next alarming remote bed to screen

If you have a bed-to-bed window open and another **Auto View** or **Auto View Always** bed goes into alarm, the selection **View Next Patient** becomes selectable. It allows you to open the bed-to-bed window to view the next highest and newest alarming patient bed.

## Viewing remote patient beds

You can select and view a networked alarming or non-alarming remote patient bed.

1. Select **Data & Pages**.
2. Select **Other Patients**.
3. Select the **View Patients** tab.
4. Select a care unit from the **Unit** list.

A list of remote patient beds is displayed for the selected care unit.

5. You can select to see a list of all patient beds in the care unit or a list of remote patient beds configured for alarm notification. Select an option from the **Show** list:
  - To show a list of all the remote beds in the care unit, select **All Patients**.
  - To show the list of remote patients configured for alarm notification, select **Notification Patients Only**.
6. Select a patient bed from the displayed list.
7. Select **View**.
8. You can stop viewing the selected patient bed and close the bed-to-bed window by selecting **Close View**.

**NOTE** Selecting the home key will not close any open bed-to-bed view of an alarming or non-alarming patient bed.

## Audio pause for a remote patient bed alarms

**NOTE** This feature is available with the CARESCAPE Network only.

You can pause active alarms for the remote bed viewed by selecting **Remote** from the bed-to-bed window. If the selection is not selectable, this option has not been enabled during configuration. It is enabled in the **Care Unit Settings** and it is password protected. In addition, the remote monitor's settings may prevent remote silencing from taking place.

## Manual printing of remote bed waveforms

**NOTE** CARESCAPE Network only.

Waveform data of a remote monitor can be manually printed by selecting **Print** from the bed-to-bed window. With the B850, waveforms are printed using the local PRN-50 recorder if available, otherwise the printer is determined by the remote monitor's print configuration. The waveforms that appear on the printout are determined by the remote monitor's print configuration.



# 31

## Interfacing with peripheral devices

### Interfacing safety precautions

#### Interfacing warnings

- WARNING** — SINGLE PATIENT USE — All eight serial ports of the Unity Network Interface Device (ID) must only be used on one patient.
- WARNING** — INTERFACING OTHER EQUIPMENT — Connect only items that are specified as part of the system and as compatible. For more information, see the supplemental information manual.
- WARNING** If a ventilator and a gas acquisition module are connected to the same monitor, the monitor issues some respiratory alarms based on the module alarm limits and not those of the ventilator. Make sure that the alarm limits on the module are set to match the patient's ventilation requirements to avoid delayed or suppressed ventilator alarm annunciation at the central station and to ensure timely clinical response to important changes in the patient's condition or the ventilator's status.

#### Interfacing cautions

- CAUTION** Always verify the compatibility of the software versions before use; refer to the Unity Network Interface Device (ID) Operator's Manual.
- CAUTION** — INSTALLATION — To avoid accidental ingress of liquids, always mount the Unity Network Interface Device (ID) in a vertical position with the connectors at the bottom.
- CAUTION** — INSTALLATION — Qualified technical personnel must connect the interface adapter to the peripheral device and make any necessary adjustments to the peripheral device (baud rate, parity, etc.) as described in the specific installation instructions for the interface adapter. Insert cabling from the connectivity device only into specified interface adapters and specified peripheral devices. To avoid inadvertent disconnection, route all cables in a way to prevent a stumbling hazard. Wrap and secure excess cabling to reduce risk of entanglement by patients and personnel. Do not install in a location where the device may drop on a person.

**CAUTION** The use of the wrong interface adapter may cause improper operation of the supported peripheral device.

**CAUTION** — TREATMENT — Do not treat the patient based solely on the alarm messages and/or numerics presented via the Unity Network Interface Device (ID). You must verify the accuracy of the alarm message and/or numerics at the peripheral device itself before initiating treatment, treatment should be based on the information presented at the peripheral device.

## Compatible peripheral devices

For a list of compatible peripheral devices, see the Unity Network Interface Device (ID) Operator's Manual.

## Unity Network Interface Device (ID)

### Software compatibility

For software compatibility information, see the Unity Network Interface Device (ID) manuals.

### About the Unity Network Interface Device (ID)



The monitor can interface with peripheral medical devices, such as ventilators and gas delivery systems, to centralize patient data on one device. A Unity Network Interface Device (ID) is used with the monitor to communicate with peripheral devices. It acquires digital data from eight individually isolated serial ports. The data is collected from up to eight peripheral devices (not necessarily manufactured by GE), and then the interface device transmits the formatted data to the monitor.

The monitor can only display information that the peripheral device sends. The parameters sent vary with each peripheral device and are subject to change. It is also important to note that alarms vary according to the primary interfaced device.

In some cases, the peripheral device may impose alarm control parameters that you may *not* be able to change or silence with the monitor's controls.

### Unity Network Interface Device (ID) interconnection

The Unity Network Interface Device (ID) connects to the monitor via one of the M-port connectors on the front of the processing unit (B850), or via the Ethernet port labeled ID on the back of the monitor (B650).

A factory-programmed adapter is required for each peripheral device to communicate with the connectivity device. Refer to the instructions provided with the interface adapter for adapter setup and installation instructions.

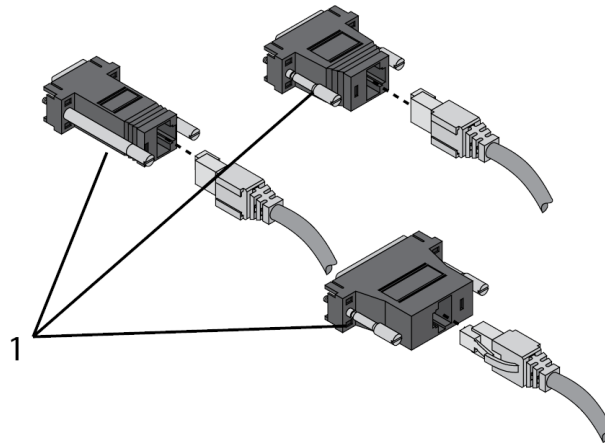

1. Interface adapters

Once the interface adapter is permanently connected to the peripheral device, the cable can be plugged into any one of the eight serial ports on the Unity Network Interface Device (ID).

**CAUTION**

The use of the wrong interface adapter may cause improper operation of the supported peripheral device.

## Unity Network Interface Device (ID) serial port indicator lights

Each serial port on the connectivity device has an indicator light located directly above it. The light indicates the status of the serial port.



1. Indicator lights
2. Serial ports

Green indicator	Yellow indicator	Serial port status	Description
Off	Off	No connection	Nothing is connected to the associated serial port or the interface connector is not operational.
Off	On	Communication pending	Cable and interface adapter are connected, but the supported device communication is not yet established.
Off	Slow blinking (once every 2 seconds)	Communication error	Connected, but communications error with supported device.
Off	Fast blinking (twice every second)	Other errors	Indicates: <ul style="list-style-type: none"> <li>• Too many supported devices of one type are connected.</li> <li>• Interface adapter is malfunctioning.</li> <li>• Supported device software is not compatible with the monitor software.</li> <li>• Interface adapter is not supported by the monitor software.</li> </ul>
On	Off	Working	Communication with the supported device is good.

## Peripheral device limit alarms

The limit alarms are not adjustable when the measurement source is from an external device connected to the Unity Network Interface Device (ID). Limit alarms can be turned on or off only.

Alarm limits or guard limits set for any parameter have no effect as only the limit alarms from the interfaced device are shown. In addition, they are shown only for those parameters that have their **Alarm On** activated.

It should also be noted that if a ventilator and a gas acquisition module are simultaneously connected to the monitor, the monitor will use the module's alarm limits and not those of the ventilator. In addition, the monitor uses the measurement data of the connected modules as the basis for its alarms.

## Peripheral device parameter data

The data from a peripheral device that is displayed at the monitor varies with each device. The chart below gives some general information as to what data is available to the monitoring system and how it is handled (trending, alarm broadcast, etc.). See the Unity Network Interface Device (ID) operator and service manuals for more detailed information regarding waveforms and alarms.

Device type	Waveforms ¹	Parameter windows	Trends	Alarm broadcast	Printouts	Real-time data to central station ²
Pulse oximeters	No	Yes	Yes	Yes	Yes	No
Transcutaneous monitors	No	Yes	Yes	Yes	Yes	No
Ventilators	Yes	Yes	Yes	Yes	Yes	Limited
Gas analyzers	No	Yes	Yes	Yes	Yes	Yes
Continuous cardiac output	No	Yes	Yes	Yes	Yes	No
Anesthesia machines	Yes	Yes	Yes	Yes	Yes	Limited
POC blood gas monitors	No	No ³	Yes	No	No	No

¹ Unity Network Interface Device (ID) supports only digital waveforms.

² CIC Pro version 4.0.7 and subsequent.

³ POC blood gas monitor data is displayed in **Data & Pages > Laboratory Data**.

## Peripheral device data presentation and menus

The data displayed in the parameter window may vary with each device. Not all menu options are available with all devices, and some menu options are not available with interfaced devices at all. Ventilators, gas analyzers, continuous cardiac output devices, and anesthesia machines are capable of sending a number of parameters to the monitor. In some cases, not all are supported, or the monitor's software package may determine the set of parameters. See the Unity Network Interface Device (ID) Operator's Manual and the peripheral device manufacturer's manuals for more information.

- Pulse oximeters
  - The SpO₂ parameter window displays a saturation value and a pulse rate. The **Ext** indicates the data is from an external source. There is no associated waveform or parameter menu. Only one SpO₂ measurement from an external source can be actively displayed on the monitor.
- SvO₂
  - The SvO₂ parameter window displays SvO₂ index data and a signal quality indicator (None, *, **, ***). For reliable saturation values, the signal strength indicator should be higher than one asterisk. The measurement range of SvO₂ is from 0 to 100%. The **Ext** indicates the data is from an external source.
- Transcutaneous pO₂/pCO₂
  - The TC parameter window displays a pCO₂ value, pO₂ value, site temperature value, and probe power value. The **Ext** indicates the data is from an external source. There is no associated waveform. Only one TC measurement from an external source can be connected and active simultaneously.
- Spirometry data from ventilators and anesthesia machines

- The monitor displays Ppeak, Pplat, Pmean, PEEPtot, PEEPi, PEEP, TVexp, TVinsp, MVexp, MVspont, Compl, Raw, I:E ratio, and static Compl measurement data.
- If there is a compact airway module measuring spirometry in the monitor, it is used as the measurement source instead of the interfaced device.
- Gas data from ventilator, anesthesia machines, and gas analyzers
  - The monitor displays CO₂, Resp Rate, O₂, N₂O, Halothane, Desflurane, Enflurane, Isoflurane and Desflurane measurement data.
  - If there is a compact airway module in the monitor, it is used as the measurement source instead of the interfaced device.
- Laboratory data
  - The monitor provides **Laboratory Data >View** and **Enter Data** menus.
- Continuous cardiac output
  - The interfaced continuous cardiac output measurement provides C.O., blood temperature, CCO, SVV, GEDI, ELWI and SVR measurements depending on the interfaced device. The **Ext** indicates the data is from an external source. The following conditions apply with the interfaced continuous cardiac output measurement:
    - ◆ The C.I. value for interfaced device is computed using the following equation  
$$\text{C.I.} = \text{C.O.} / \text{BSA}.$$
    - ◆ The C.I. value for interfaced device is invalid if BSA from the monitor is not available.
    - ◆ The CCI value for interfaced device is computed using the following equation  
$$\text{CCI} = \text{CCO} / \text{BSA}.$$
    - ◆ The CCI value for interfaced device is invalid if BSA from the monitor is not available.
    - ◆ The SVR value for the interfaced device shall be computed using the following equation  $\text{SVR} = ((\text{MAP} - \text{CVP}) / \text{CCO}) * 79.92.$
    - ◆ The SVR value for the interfaced device shall be invalid if MAP, CVP or CCO from the monitor are not available.
    - ◆ The SVRI value for interfaced device shall be computed using the following equation  $\text{SVRI} = ((\text{MAP} - \text{CVP}) / \text{CCI}) * 79.92.$
    - ◆ The SVRI value for the interfaced device shall be invalid if MAP, CVP or CCI from the monitor are not available.
    - ◆ Tblood value is displayed. The **Tblood - T1** temperature alarm limit is adjustable.
- Ventilator/anesthesia machine settings and technical alarms
  - The settings are displayed in numeric trends.
  - Technical alarms and settings are displayed and trended even when there is a gas module connected to the monitor.

## Cleaning and care

### Cleaning and care safety precautions

#### Cleaning and care warnings

- |                |                                                                                                                                                                                                                                                                     |
|----------------|---------------------------------------------------------------------------------------------------------------------------------------------------------------------------------------------------------------------------------------------------------------------|
| <b>WARNING</b> | Before cleaning or disinfecting, disconnect the monitor from the power supply.                                                                                                                                                                                      |
| <b>WARNING</b> | Regular preventive maintenance should be carried out annually. Failure to implement the recommended maintenance schedule may cause equipment failure and possible health hazards.                                                                                   |
| <b>WARNING</b> | The user may only perform maintenance procedures specifically described in this manual.                                                                                                                                                                             |
| <b>WARNING</b> | Non-medical equipment does not provide the same level of protection against electrical shock. Do not touch the patient and any part of non-medical equipment at the same time. Some examples of non-medical equipment are laser printers and non-medical computers. |
| <b>WARNING</b> | Avoid use of cleaners, materials or chemicals that may damage device surfaces, labels, or cause equipment failures.                                                                                                                                                 |
| <b>WARNING</b> | To prevent liquids from entering the monitor or display casing, do not tilt the monitor or display more than +/-15 degrees.                                                                                                                                         |
| <b>WARNING</b> | If liquid has accidentally entered the system or its parts, disconnect the power cord from the power supply and have the equipment serviced by authorized service personnel.                                                                                        |
| <b>WARNING</b> | Use only washable keyboard with at least IPX1 protection against ingress of water.                                                                                                                                                                                  |
| <b>WARNING</b> | Cleanup and disposal of broken display monitors must be in compliance with the safety and waste control guidelines regulating this product.                                                                                                                         |
| <b>WARNING</b> | Never immerse any part of the device, cables, or leadwires in liquids or allow liquid to enter the interior of the device.                                                                                                                                          |

- WARNING** Do not autoclave any part of the system with steam (including cables or leadwires) or sterilize with ethylene oxide.
- WARNING** Do not pour or spray any liquid directly on cables or leadwires or permit fluid to seep into connections or openings.
- WARNING** Never use conductive solutions, solutions that contain chlorides, wax, or wax compounds to clean devices, cables or leadwires.
- WARNING** Since calibration gas contains anesthetic agents, always ensure sufficient ventilation of the room during calibration.

## Cleaning and care cautions

- CAUTION** Do not apply pressurized air or gas to any outlet or tubing connected to the monitor. Pressure may destroy sensitive elements.
- CAUTION** Do not use or store equipment outside the specified temperature, humidity, or altitude ranges.

## Disposal safety precautions

### Disposal warnings

- WARNING** Do not incinerate a battery or store at high temperatures. Serious injury or death could result.

### Disposal cautions

- CAUTION** — DISPOSAL — At the end of its service life, the product described in this manual, as well as its accessories, must be disposed of in compliance with the guidelines regulating the disposal of each product. If you have any questions concerning disposal of a product, please contact GE or its representatives.
- CAUTION** — PACKAGING DISPOSAL — Dispose of the packaging material, observing the applicable waste control regulations.

## Cleaning and care schedules

See the technical manuals for more comprehensive checks.

For details about cleaning, disinfecting and sterilizing the accessories, see the instructions for use in the accessory package.

Do not reuse single-use disposable accessories.

### Daily checks

- Check that the accessories, cables, cable connectors, monitor, modules, and display parts are clean and intact.



- B650: Check the charge of the optional monitor battery.

## Monthly checks

- Check the gas exchange calibration.

## Check every two months

- Change the water trap.
- Check the airway gases calibration if the measurement is in continuous use.

## Check every six months

- Check the airway gases calibration if the measurement is in normal (not continuous) use.

## Once a year checks

- Check the calibration of temperature, NIBP and invasive blood pressure.

### NOTE

The invasive blood pressure transducers should be calibrated whenever a transducer error occurs.

- Check the Patient Spirometry flow calibration.

## Regular calibration checks

The following parameters require calibration checks at regular intervals, in addition to the calibration performed while monitoring patients.

- Airway gases
  - The recommended calibration interval for airway gas measurements is every six months in normal use and every two months in continuous use, to ensure that the measurement accuracy remains within specifications. Familiarize yourself with instructions regarding the airway gases measurement, including the calibration instructions.
- Patient Spirometry
  - If the difference between the inspiratory and expiratory volumes is permanent, a flow calibration is required. For calibration instructions, see the Module Frames and Modules Technical Manual.
- Gas exchange
  - The recommended gas exchange calibration interval is once a month to ensure that the measurement accuracy remains within specifications. For calibration instructions, see the Module Frames and Modules Technical Manual.
- Temperature, NIBP, and invasive pressures
  - A calibration check of temperature, NIBP and invasive blood pressures should be performed at least once a year to ensure that the measurement accuracy remains within specifications. For calibration instructions, see the Module Frames and Modules Technical Manual.

## Cleaning and care points to note

- Do not let liquid pool around connection pins. If this should happen, blot dry with a soft, lint-free cloth.
- Do not use excessive drying techniques, such as oven, forced heat, or sun drying.

- Do not spray cleaner directly on the display screen.
- Never connect any device or applied part to a patient until it is thoroughly dry.

## Permitted detergents

- Water.
- Mild soap.

## Permitted disinfectants

- Ethanol max. 99.7% by volume for surfaces, excluding B850 CPU, USB remote, M-port keypad surfaces.
- Ethanol max. 70% by volume for B850 CPU, USB remote, M-port keypad surfaces.
- Isopropyl alcohol (max. 60% by weight).
- Chloramine (max. 5% by volume).
- Glutaraldehyde (max. 2% by volume).
- Phenol (max. 2% by volume).
- Tartaric acid (75 mg per 100 ml solution).
- Sodium hypochlorite (max. 5.25% by volume mixed with H₂O in ratio of 1:10). Do not use this disinfectant for touch screen panels.

## Cleaning and care instructions

### Setting the touchscreen off for cleaning

You can set the touchscreen feature off for 30 seconds at a time when you need to clean the screen. The countdown timer appears on the screen.

1. Select **Monitor Setup**.
2. Select **Touchscreen Off**.
3. You can enable the touchscreen immediately by pressing any monitor hardkey or the Trim Knob, or by selecting **Cancel** in the **Touchscreen Off** display.

### Cleaning non-applied parts, general instructions

Follow these instructions to clean the monitor, modules, display screen surfaces, EEG headbox, and other non-applied parts unless there are separate part-specific instructions.

1. Turn off the power to the equipment.
2. Disconnect the equipment from the power supply.
3. Remove all cables and batteries (if applicable) and close battery door(s).
4. Dampen a soft lint-free cloth with one of the permitted detergents or disinfectants.
5. Wring excess liquid from the cloth and wipe the exterior surface.  
Any contact of disinfectant solutions with metal parts may cause corrosion.  
Do not damage or bend connector pins when cleaning or drying.

6. Allow solution to remain on device for a minimum of one minute or per hospital guidelines.  
Do not let fluid pool around connection pins. If this happens, blot dry with a cotton swab or soft cloth.
7. Wipe off the cleaning solutions with a clean, lightly moistened cloth.
8. Dry thoroughly with a dry, lint-free cloth and let air dry for at least 30 minutes.  
Drying times may vary based on the environmental conditions.
9. Insert batteries (if applicable) and close battery doors.
10. Reconnect the equipment to the power supply.
11. Turn on the power to the equipment.

## Barcode reader cleaning instructions

Do not submerge the barcode reader in water. Do not use abrasive wipes or tissues on the barcode reader's window – abrasive wipes may scratch the window. Never use solvents (e.g., acetone, benzene, ether, or phenol-based agents) on the housing or window as solvents may damage the finish or the window.

Reading performance may degrade if the reader's window is not clean. If the window is visibly dirty, or if the reader isn't operating well, clean the window with a soft cloth or lens tissue dampened with water (or a mild detergent- water solution). If a detergent solution is used, rinse with a clean lens tissue dampened with water only.

The reader's housing may also be cleaned the same way.

## Keyboard and mouse cleaning instructions

Refer to the user documentation provided with the keyboard and mouse for instructions on how to clean them. Always consider your hospital guidelines as well.

## Cleaning applied parts, general instructions

Follow these instructions to clean applied parts unless there are separate part-specific instructions. Always refer to the accessories' own instructions for use for detailed information.

Cables and leadwires can be cleaned with a warm, damp cloth and mild soap. Consult manufacturer instructions for recommended cleaning methods and products.

For other applied parts such as temperature sensors, catheters, pulse oximetry probes, and other reusable accessory parts, consult the manufacturer instructions for cleaning, sterilization, or disinfecting methods.

To clean ECG trunk cables, NIBP cuff and cables, reusable sensors:

1. Remove cables and leadwires from the handheld device or system before cleaning.
2. Use care in cleaning leadwires to prevent pulling the long wires from the connector ends. Metal connections can be pulled away from the connectors.
3. For general cleaning of cables and leadwires, wipe using a lightly moistened cloth with a mild soap and water solution.

4. For disinfecting the cables and leadwires, wipe exterior with a soft lint-free cloth, using a chemical disinfectant. Refer to the cables' and leadwires' own instructions for use for detailed information regarding allowed substances.

Wring excess disinfectant from wipe before using.

Any contact of disinfectant solutions with metal parts may cause corrosion.

Do not immerse either end of a cable or leadwire connector. Immersing or soaking the connector ends may corrode metal contact ends and affect signal quality.

5. Wipe off cleaning solutions with a clean, lightly moistened cloth.
6. Dry thoroughly with a dry, lint-free cloth and let air dry for at least 30 minutes.  
Drying times may vary based on the environmental conditions. Do not apply heat.

## Reusable D-lite and Pedi-lite sensor cleaning instructions

Reusable D-lite and Pedi-lite sensors can be washed, disinfected, or steam autoclaved. Make sure that the sensor is dry and the connectors are not damaged. A tight connection is essential for correct measurement.

## D-fend(+), D-fend Pro(+), and Mini D-fend water trap care instructions

- Empty the container whenever it is more than half full.
- In anesthesia: Replace the D-fend, D-fend Pro, or Mini D-fend water trap every two months or when **Replace Water Trap** appears.
- In critical care: Replace the D-fend+, D-fend Pro+, or Mini D-fend water trap every 24 hours, for each new patient, or when the message **Replace Water Trap** appears.
- When taking a new water trap into use, mark the date on the appropriate label on the water trap cartridge: 
- The water trap cartridge is disposable. Do not wash or reuse the cartridge.

## CAPNOSTAT sensor and adapter cleaning instructions

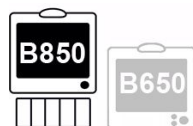

B850 only.

- Clean the sensor surfaces with a damp cloth and allow to dry. Do not immerse the sensor or attempt to sterilize the sensor. Before reusing, make sure the sensor windows are clean and dry.
- Clean the adapter by rinsing in a warm soapy solution, followed by soaking in a liquid disinfectant, pasteurized, or cold sterilized (Glutaraldehyde). Rinse thoroughly with sterilized water and allow to dry. Before reusing the adapter, make sure the adapter windows are clean and dry.

## How to store PDM and PSM

- Remove PDM batteries when the device is not in use, even for short periods of time.
- Store in a dry well-ventilated area.
- Hang the device using a holder if available.

- If leadwires or cables are attached, hang them straight.
- Do not coil leadwires or cables tightly around the device.

## Monitor battery care

### Replacing the monitor battery

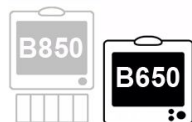

B650 only.

#### **WARNING**

— EXPLOSION OR FIRE — Using non-recommended batteries could result in injury/burns to the patients or users. Only use batteries recommended or manufactured by GE. The warranty can be voided if non-recommended batteries are used.

#### **WARNING**

— PHYSICAL INJURY — Make sure the battery is completely inserted and the battery door is completely closed. Falling batteries could seriously or fatally injure neonatal or other vulnerable patients.

1. Open the battery slot by gently turning the lock counter-clockwise.
2. Pull the battery out using the battery strap.
3. Insert a new battery all the way with the test button facing up.
4. Close the battery slot by turning the lock clockwise.

### Battery recycling

When a battery no longer holds a charge, it should be replaced. Remove the old battery and follow your local recycling guidelines.

#### **WARNING**

Do not incinerate a battery or store at high temperatures. Serious injury or death could result.

## PDM battery care

The PDM uses one rechargeable lithium-ion battery. For more information, see the technical manual.

### About PDM battery charging

**B850:** The PDM battery is charged whenever the PDM, with its battery installed, is connected to a monitor that is connected to an AC-derived power source. The battery capacity gauge (labeled with text PDM) indicates the battery's charge level.

**B650:** The PDM battery is normally charged whenever the PDM, with its battery installed, is connected to the monitor unless the monitor battery is being charged or printing to a recorder is active.

You can also charge PDM on an external charger. Refer to the charger's instructions for use.

## Replacing the PDM battery

**WARNING** — EXPLOSION OR FIRE — Using non-recommended batteries could result in injury/burns to the patients or users. Only use batteries recommended or manufactured by GE. The warranty can be voided if non-recommended batteries are used.

**WARNING** — PHYSICAL INJURY — Do not install the PDM above a patient. Make sure the battery is completely inserted and the battery door is completely closed. Falling batteries could seriously or fatally injure neonatal or other vulnerable patients.

**WARNING** — PHYSICAL INJURY — Do not install the PDM above a patient. Leaks from the battery cells can occur under extreme conditions. The liquid is caustic to the eyes and skin. If the liquid comes in contact with eyes or skin, flush with clean water and seek medical attention.

1. Open the battery door by gently pulling on the battery door pull tab.
2. Pull the battery tray out of the PDM using the battery tray strap and remove the battery from the battery tray.
3. Insert the new battery with the test button facing up and the arrow pointing into the PDM.
4. Press the battery door closed until it seals the battery compartment.
5. Connect the PDM to the monitor.
6. Confirm the PDM battery capacity gauge displays on the monitor.

## Battery recycling

When a battery no longer holds a charge, it should be replaced. Remove the old battery and follow your local recycling guidelines.

**WARNING** Do not incinerate a battery or store at high temperatures. Serious injury or death could result.

## About the internal lithium battery

The monitor contains a lithium battery. This battery retains the correct time and date on the monitor.

If the lithium battery charge becomes low during normal operation, the message **Service Monitor Error Code 0xHOST1100** appears near the middle of the screen. If this happens, contact authorized service personnel.

# 33

## Messages

### Messages related to ECG measurement

For information regarding alarm priorities and escalation times, see the supplemental information manual.

Make sure you are familiar with the generic layout of the screen. This will help you identify where on screen the following messages appear. The message location is indicated with the following abbreviations:

- al. area = alarm area
- param. = parameter window
- report = report view
- wavef. = waveform area

Message	Location	Explanation	What to do
<ul style="list-style-type: none"><li>• <b>12 diagnostic leads needed</b></li></ul>	<ul style="list-style-type: none"><li>• report</li></ul>	Some of the ECG leads are disconnected.	<ul style="list-style-type: none"><li>• Check that all ECG leads are connected to the patient.</li></ul>
<ul style="list-style-type: none"><li>• <b>ACI-TIPI on - age less than 16</b></li></ul>	<ul style="list-style-type: none"><li>• report</li></ul>	The setting is ON but the patient is under 16 years old.	<ul style="list-style-type: none"><li>• Set the ACI-TIPI to off to create 12SL reports.</li><li>• Adjust the patient age on the monitor if it is not correct.</li></ul>
<ul style="list-style-type: none"><li>• <b>ACI-TIPI on - chest or left arm pain not entered</b></li></ul>	<ul style="list-style-type: none"><li>• report</li></ul>	The setting is ON but chest or left arm pain information has not been entered.	<ul style="list-style-type: none"><li>• Set the ACI-TIPI to off.</li><li>• Enter chest or left arm pain information.</li></ul>
<ul style="list-style-type: none"><li>• <b>A Fib</b></li></ul>	<ul style="list-style-type: none"><li>• al. area, wavef.</li></ul>	Physiological alarm.	<ul style="list-style-type: none"><li>• Check the patient status.</li></ul>
<ul style="list-style-type: none"><li>• <b>Accel. Ventric.</b></li></ul>	<ul style="list-style-type: none"><li>• al. area, wavef.</li></ul>	Physiological alarm.	<ul style="list-style-type: none"><li>• Check the patient status.</li></ul>
<ul style="list-style-type: none"><li>• <b>Arrh off</b></li></ul>	<ul style="list-style-type: none"><li>• param.</li></ul>	The arrhythmia detection level is set to <b>Off</b> .	<ul style="list-style-type: none"><li>• If arrhythmia detection is needed, set the detection level to <b>Full</b> or <b>Lethal</b>.</li></ul>
<ul style="list-style-type: none"><li>• <b>Arrhythmia paused</b></li><li>• <b>Arrh paused</b></li></ul>	<ul style="list-style-type: none"><li>• al. area</li><li>• wavef.</li></ul>	ECG channels have not been available for analysis for the last 20 seconds or the internal HR calculation has not been updated for the last 30 seconds due to excessive artifact.	<ul style="list-style-type: none"><li>• Check the patient status.</li><li>• Check electrode placement.</li><li>• Prepare the patient's skin at electrode sites.</li><li>• Change or move electrodes.</li></ul>

Message	Location	Explanation	What to do
<ul style="list-style-type: none"> <li>• <b>Artifact</b></li> </ul>	<ul style="list-style-type: none"> <li>• wavef.</li> </ul>	Muscle artifact or high or low frequency noise.	<ul style="list-style-type: none"> <li>• Check electrode contact.</li> <li>• Check lead placement.</li> <li>• Perform skin preparation.</li> <li>• Reposition/replace electrodes.</li> <li>• Request the patient to remain still.</li> </ul>
<ul style="list-style-type: none"> <li>• <b>Asystole</b></li> </ul>	<ul style="list-style-type: none"> <li>• al. area, param., wavef.</li> </ul>	Physiological alarm.	<ul style="list-style-type: none"> <li>• Check the patient status.</li> </ul>
<ul style="list-style-type: none"> <li>• <b>Bigeminy</b></li> </ul>	<ul style="list-style-type: none"> <li>• al. area, wavef.</li> </ul>	Physiological alarm.	<ul style="list-style-type: none"> <li>• Check the patient status.</li> </ul>
<ul style="list-style-type: none"> <li>• <b>Brady</b></li> </ul>	<ul style="list-style-type: none"> <li>• al. area, wavef.</li> </ul>	Physiological alarm.	<ul style="list-style-type: none"> <li>• Check the patient status.</li> </ul>
<ul style="list-style-type: none"> <li>• <b>Cable off</b></li> </ul>	<ul style="list-style-type: none"> <li>• report</li> </ul>	ECG cable is off.	<ul style="list-style-type: none"> <li>• Connect the cable.</li> </ul>
<ul style="list-style-type: none"> <li>• <b>Change telemetry battery</b></li> </ul>	<ul style="list-style-type: none"> <li>• al. area</li> </ul>	The telemetry transmitter's battery has little charge left.	<ul style="list-style-type: none"> <li>• Change the battery.</li> </ul>
<ul style="list-style-type: none"> <li>• <b>Duplicate TTX</b></li> </ul>	<ul style="list-style-type: none"> <li>• al. area</li> </ul>	Multiple patients have been admitted using the same TTX number.	<ul style="list-style-type: none"> <li>• Contact authorized service personnel.</li> </ul>
<ul style="list-style-type: none"> <li>• <b>ECG error</b></li> </ul>	<ul style="list-style-type: none"> <li>• al. area</li> </ul>	The module has a communication error.	<ul style="list-style-type: none"> <li>• Check the module.</li> <li>• Replace the module if necessary.</li> </ul>
<ul style="list-style-type: none"> <li>• <b>ECG measurements removed</b></li> </ul>	<ul style="list-style-type: none"> <li>• al. area</li> </ul>	Acquisition module has lost ECG communication.	<ul style="list-style-type: none"> <li>• Remove the module and then reconnect it.</li> <li>• Replace the module.</li> <li>• If the problem persists, contact authorized service personnel.</li> </ul>
<ul style="list-style-type: none"> <li>• <b>Failure connecting to transmitter</b></li> </ul>	<ul style="list-style-type: none"> <li>• al.area</li> </ul>	Connection to the telemetry transmitter could not be established.	<ul style="list-style-type: none"> <li>• Retry connecting.</li> <li>• If the problem persists, contact authorized service personnel.</li> </ul>
<ul style="list-style-type: none"> <li>• <b>Frequent PVCs</b></li> </ul>	<ul style="list-style-type: none"> <li>• al. area</li> </ul>	Physiological alarm.	<ul style="list-style-type: none"> <li>• Check the patient status.</li> </ul>
<ul style="list-style-type: none"> <li>• <b>Frequent SVCs</b></li> </ul>	<ul style="list-style-type: none"> <li>• al. area, wavef.</li> </ul>	Physiological alarm.	<ul style="list-style-type: none"> <li>• Check the patient status.</li> </ul>
<ul style="list-style-type: none"> <li>• <b>Gender is not defined</b></li> </ul>	<ul style="list-style-type: none"> <li>• report</li> </ul>	ACI-TIPI has been selected on, but the patient's gender has not been entered.	<ul style="list-style-type: none"> <li>• Enter the patient's gender.</li> </ul>
<ul style="list-style-type: none"> <li>• <b>HR(ECG) high / HR(ECG) low</b></li> </ul>	<ul style="list-style-type: none"> <li>• al. area</li> </ul>	Measurement values are equal to or outside the alarm limits.	<ul style="list-style-type: none"> <li>• Check the patient status.</li> <li>• Adjust alarm limits if necessary.</li> </ul>



Message	Location	Explanation	What to do
<ul style="list-style-type: none"> <li>• <b>HR high / HR low</b></li> </ul>	<ul style="list-style-type: none"> <li>• al. area</li> </ul>	Measurement values are equal to or outside the alarm limits.	<ul style="list-style-type: none"> <li>• Check the patient status.</li> <li>• Adjust alarm limits if necessary.</li> </ul>
<ul style="list-style-type: none"> <li>• <b>Irregular</b></li> </ul>	<ul style="list-style-type: none"> <li>• al. area, wavef.</li> </ul>	Physiological alarm.	<ul style="list-style-type: none"> <li>• Check the patient status.</li> </ul>
<ul style="list-style-type: none"> <li>• <b>LA/L lead off</b></li> <li>• <b>LL/F lead off</b></li> <li>• <b>RA/R lead off</b></li> <li>• <b>RL/N lead off</b></li> </ul>	<ul style="list-style-type: none"> <li>• wavef.</li> </ul>	An electrode is disconnected.	<ul style="list-style-type: none"> <li>• Check the electrodes.</li> </ul>
<ul style="list-style-type: none"> <li>• <b>Lead changed</b></li> </ul>	<ul style="list-style-type: none"> <li>• wavef.</li> </ul>	The monitor automatically switches the ECG1 waveform selection to a measurable ECG Lead (I, II, III, aVR, aVL, aVF, V1, V2, V3, V4, V5 or V6) if the current ECG1 waveform is not measurable.	<ul style="list-style-type: none"> <li>• Note that the ECG waveform changes according to the lead it is measured from. Check the lead.</li> </ul>
<ul style="list-style-type: none"> <li>• <b>Leads off</b></li> </ul>	<ul style="list-style-type: none"> <li>• al. area, wavef.</li> </ul>	One or more of the connected electrodes is disconnected and arrhythmia detection is not possible.	<ul style="list-style-type: none"> <li>• ECG: Check the connections.</li> </ul>
<ul style="list-style-type: none"> <li>• <b>Learning</b></li> </ul>	<ul style="list-style-type: none"> <li>• wavef.</li> </ul>	ST algorithm is in learning phase, message shown e.g. when ECG measurement is started.	<ul style="list-style-type: none"> <li>• No action required.</li> </ul>
<ul style="list-style-type: none"> <li>• <b>Missing beat</b></li> </ul>	<ul style="list-style-type: none"> <li>• al. area, wavef.</li> </ul>	Physiological alarm.	<ul style="list-style-type: none"> <li>• Check the patient status.</li> </ul>
<ul style="list-style-type: none"> <li>• <b>Multifocal PVCs</b></li> </ul>	<ul style="list-style-type: none"> <li>• al. area, wavef.</li> </ul>	Physiological alarm.	<ul style="list-style-type: none"> <li>• Check the patient status.</li> </ul>
<ul style="list-style-type: none"> <li>• <b>No 10 or 6 lead cable</b></li> </ul>	<ul style="list-style-type: none"> <li>• report</li> </ul>	No 6- or 10-lead ECG cable is attached.	<ul style="list-style-type: none"> <li>• Connect a 6- or 10-lead cable.</li> </ul>
<ul style="list-style-type: none"> <li>• <b>No 12RL license</b></li> </ul>	<ul style="list-style-type: none"> <li>• report</li> </ul>	No 12RL 12 lead ECG license.	<ul style="list-style-type: none"> <li>• Contact your GE representative to purchase this feature.</li> </ul>
<ul style="list-style-type: none"> <li>• <b>No 12SL license</b></li> </ul>	<ul style="list-style-type: none"> <li>• report</li> </ul>	No 12SL ECG with ACI-TIPI license.	<ul style="list-style-type: none"> <li>• Contact your GE representative to purchase this feature.</li> </ul>
<ul style="list-style-type: none"> <li>• <b>No telemetry</b></li> </ul>	<ul style="list-style-type: none"> <li>• al. area</li> </ul>	The server cannot communicate with the telemetry transmitter.	<ul style="list-style-type: none"> <li>• Make sure the transmitter is not out of range.</li> <li>• Check the telemetry transmitter's battery.</li> <li>• Wait to see if the problem resolves. If the problem persists, contact authorized service personnel.</li> </ul>

Message	Location	Explanation	What to do
<ul style="list-style-type: none"> <li>• <b>Noise</b></li> </ul>	<ul style="list-style-type: none"> <li>• wavef.</li> </ul>	Arrhythmia alarm category has been set to <b>Off</b> in the <b>ECG</b> , and the ECG channels have not been available for analysis for the last 20 seconds or the internal HR calculation has not been updated for the last 30 seconds due to excessive noise which compromises the accuracy of detecting events.	<ul style="list-style-type: none"> <li>• Remove the source of excessive noise if possible.</li> </ul>
<ul style="list-style-type: none"> <li>• <b>Noisy ECG</b></li> </ul>	<ul style="list-style-type: none"> <li>• al. area</li> </ul>	Arrhythmia alarm category has been set to <b>Off</b> through <b>ECG &gt; Arrhythmia &gt; Lethal Alarms</b> , and the ECG channels have not been available for analysis for the last 20 seconds or the internal HR calculation has not been updated for the last 30 seconds due to excessive noise which compromises the accuracy of detecting events.	<ul style="list-style-type: none"> <li>• Check and remove sources of excessive noise.</li> </ul>
<ul style="list-style-type: none"> <li>• <b>Pause</b></li> </ul>	<ul style="list-style-type: none"> <li>• al. area, wavef.</li> </ul>	Physiological alarm.	<ul style="list-style-type: none"> <li>• Check the patient status.</li> </ul>
<ul style="list-style-type: none"> <li>• <b>Please wait - collecting waveform</b></li> </ul>	<ul style="list-style-type: none"> <li>• report</li> </ul>	There is not enough ECG sample data to run the algorithm.	<ul style="list-style-type: none"> <li>• Wait for about 10 seconds.</li> </ul>
<ul style="list-style-type: none"> <li>• <b>QT high</b></li> </ul>	<ul style="list-style-type: none"> <li>• al. area</li> </ul>	Measurement values are equal to or outside the alarm limits.	<ul style="list-style-type: none"> <li>• Check the patient status.</li> <li>• Adjust alarm limits if necessary.</li> </ul>
<ul style="list-style-type: none"> <li>• <b>QTc high</b></li> </ul>	<ul style="list-style-type: none"> <li>• al. area</li> </ul>	Measurement values are equal to or outside the alarm limits.	<ul style="list-style-type: none"> <li>• Check the patient status.</li> <li>• Adjust alarm limits if necessary.</li> </ul>
<ul style="list-style-type: none"> <li>• <b>R on T</b></li> </ul>	<ul style="list-style-type: none"> <li>• al. area, wavef.</li> </ul>	Physiological alarm.	<ul style="list-style-type: none"> <li>• Check the patient status.</li> </ul>
<ul style="list-style-type: none"> <li>• <b>Remove one ECG module</b></li> </ul>	<ul style="list-style-type: none"> <li>• al. area</li> </ul>	There are two ECG modules in the system.	<ul style="list-style-type: none"> <li>• Remove one ECG module.</li> </ul>
<ul style="list-style-type: none"> <li>• <b>Single PVC</b></li> </ul>	<ul style="list-style-type: none"> <li>• al. area, wavef.</li> </ul>	Physiological alarm.	<ul style="list-style-type: none"> <li>• Check the patient status.</li> </ul>
<ul style="list-style-type: none"> <li>• <b>ST Ant high / ST Ant low</b></li> <li>• <b>ST Inf high / ST Inf low</b></li> <li>• <b>ST Lat high / ST Lat low</b></li> </ul>	<ul style="list-style-type: none"> <li>• al. area, param.</li> </ul>	Measurement values are equal to or outside the alarm limits.	<ul style="list-style-type: none"> <li>• Check the patient status.</li> <li>• Adjust alarm limits if necessary.</li> </ul>
<ul style="list-style-type: none"> <li>• <b>ST XXX high / ST XXX low</b></li> </ul> <p>where XXX = ECG lead label</p>	<ul style="list-style-type: none"> <li>• al. area</li> </ul>	Measurement values are equal to or outside the alarm limits.	<ul style="list-style-type: none"> <li>• Check the patient status.</li> <li>• Adjust alarm limits if necessary.</li> </ul>

Message	Location	Explanation	What to do
<ul style="list-style-type: none"> <li>• <i>SV Tachy</i></li> </ul>	<ul style="list-style-type: none"> <li>• al. area, wavef.</li> </ul>	Physiological alarm.	<ul style="list-style-type: none"> <li>• Check the patient status.</li> </ul>
<ul style="list-style-type: none"> <li>• <i>Telemetry patient: No 12SL available</i></li> </ul>	<ul style="list-style-type: none"> <li>• param.</li> </ul>	12SL is not available with telemetry.	<ul style="list-style-type: none"> <li>• If 12SL is required, use a module that is directly connected to the monitor instead of a telemetry transmitter.</li> </ul>
<ul style="list-style-type: none"> <li>• <i>Tachy</i></li> </ul>	<ul style="list-style-type: none"> <li>• al. area, wavef.</li> </ul>	Physiological alarm.	<ul style="list-style-type: none"> <li>• Check the patient status.</li> </ul>
<ul style="list-style-type: none"> <li>• <i>Telemetry battery empty</i></li> </ul>	<ul style="list-style-type: none"> <li>• al. area</li> </ul>	The telemetry transmitter's battery has no charge left.	<ul style="list-style-type: none"> <li>• Change the battery.</li> </ul>
<ul style="list-style-type: none"> <li>• <i>Trigeminy</i></li> </ul>	<ul style="list-style-type: none"> <li>• al. area, wavef.</li> </ul>	Physiological alarm.	<ul style="list-style-type: none"> <li>• Check the patient status.</li> </ul>
<ul style="list-style-type: none"> <li>• <i>TTX Off Network</i></li> </ul>	<ul style="list-style-type: none"> <li>• al. area</li> </ul>	No parameter or waveform data has been received from the telemetry transmitter for more than 5 seconds.	<ul style="list-style-type: none"> <li>• Wait to see if the condition resolves. If the problem persists, contact authorized service personnel.</li> </ul>
<ul style="list-style-type: none"> <li>• <i>V Brady</i></li> </ul>	<ul style="list-style-type: none"> <li>• al. area, wavef.</li> </ul>	Physiological alarm.	<ul style="list-style-type: none"> <li>• Check the patient status.</li> </ul>
<ul style="list-style-type: none"> <li>• <i>V Fib/V Tach</i></li> </ul>	<ul style="list-style-type: none"> <li>• al. area, param., wavef.</li> </ul>	Physiological alarm.	<ul style="list-style-type: none"> <li>• Check the patient status.</li> </ul>
<ul style="list-style-type: none"> <li>• <i>V lead A is not V1 or V lead B is not V5</i></li> </ul>	<ul style="list-style-type: none"> <li>• report</li> </ul>	Va lead is not V1 and/or Vb lead is not V5.	<ul style="list-style-type: none"> <li>• Check the settings and correct if necessary.</li> </ul>
<ul style="list-style-type: none"> <li>• <i>V leads off</i></li> </ul>	<ul style="list-style-type: none"> <li>• report</li> </ul>	All V leads are off.	<ul style="list-style-type: none"> <li>• Connect the V leads to the patient.</li> </ul>
<ul style="list-style-type: none"> <li>• <i>V Tach</i></li> </ul>	<ul style="list-style-type: none"> <li>• al. area, param., wavef.</li> </ul>	Physiological alarm.	<ul style="list-style-type: none"> <li>• Check the patient status.</li> </ul>
<ul style="list-style-type: none"> <li>• <i>V2/C2 lead off</i></li> <li>• <i>V3/C3 lead off</i></li> <li>• <i>V4/C4 lead off</i></li> <li>• <i>V5/C5 lead off</i></li> <li>• <i>V6/C6 lead off</i></li> <li>• <i>V/C lead off</i></li> <li>• <i>Va/Ca lead off</i></li> <li>• <i>Vb/Cb lead off</i></li> </ul>	<ul style="list-style-type: none"> <li>• wavef.</li> </ul>	An electrode is disconnected.	<ul style="list-style-type: none"> <li>• Check the electrodes.</li> </ul>
<ul style="list-style-type: none"> <li>• <i>VT&gt;2</i></li> </ul>	<ul style="list-style-type: none"> <li>• al. area, wavef.</li> </ul>	Physiological alarm.	<ul style="list-style-type: none"> <li>• Check the patient status.</li> </ul>

## Messages related to impedance respiration measurement

For information regarding alarm priorities and escalation times, see the supplemental information manual.

Make sure you are familiar with the generic layout of the screen. This will help you identify where on screen the following messages appear. The message location is indicated with the following abbreviations:

- al. area = alarm area
- param. = parameter window
- report = report view
- wavef. = waveform area

Message	Location	Explanation	What to do
<ul style="list-style-type: none"> <li>• <b>Apnea (Imped)</b></li> </ul>	<ul style="list-style-type: none"> <li>• al. area, wavef.</li> </ul>	No breathing detected.	<ul style="list-style-type: none"> <li>• Check the patient status.</li> <li>• Check the ventilator and breathing status.</li> </ul>
<ul style="list-style-type: none"> <li>• <b>Apnea deactivated</b></li> </ul>	<ul style="list-style-type: none"> <li>• param.</li> </ul>	The case has just been started/patient admitted on the monitor, or the measurement has just been started.	<ul style="list-style-type: none"> <li>• Wait. The message disappears after the monitor detects 3 breaths (E-modules) or the respiration rate is $\geq 3$ (PDM, TRAM).</li> </ul>
<ul style="list-style-type: none"> <li>• <b>Artifact</b></li> </ul>	<ul style="list-style-type: none"> <li>• param., wavef.</li> </ul>	Cardiac artifact has been detected.	<ul style="list-style-type: none"> <li>• Check the patient status.</li> <li>• Select alternate leads to monitor.</li> <li>• Increase sensitivity settings.</li> <li>• Select alternate lead placement.</li> <li>• Relearn respiration.</li> </ul>
<ul style="list-style-type: none"> <li>• <b>Cardiac artifact</b></li> </ul>	<ul style="list-style-type: none"> <li>• al. area</li> </ul>	Cardiac artifact has been detected.	<ul style="list-style-type: none"> <li>• Check the patient status.</li> <li>• Select alternate leads to monitor.</li> <li>• Increase sensitivity settings.</li> <li>• Select alternate lead placement.</li> <li>• Relearn respiration.</li> </ul>
<ul style="list-style-type: none"> <li>• <b>LA/L lead off</b></li> <li>• <b>Lead I failed</b></li> <li>• <b>Lead II failed</b></li> <li>• <b>Lead RL-LL failed</b></li> <li>• <b>LL/F lead off</b></li> <li>• <b>RA/R lead off</b></li> </ul>	<ul style="list-style-type: none"> <li>• param., wavef.</li> </ul>	One of the electrodes is off.	<ul style="list-style-type: none"> <li>• Check the electrodes and their connections.</li> </ul>

Message	Location	Explanation	What to do
<ul style="list-style-type: none"> <li>• <b>Measurement off</b></li> </ul>	<ul style="list-style-type: none"> <li>• param., wavef.</li> </ul>	ECG leads not connected to the patient.	<ul style="list-style-type: none"> <li>• Connect the ECG leads to the patient to start the impedance respiration measurement.</li> </ul>
<ul style="list-style-type: none"> <li>• <b>Relearning</b></li> </ul>	<ul style="list-style-type: none"> <li>• param., wavef.</li> </ul>	The patient's breathing pattern is being relearned or a lead has been changed.	<ul style="list-style-type: none"> <li>• Wait until the message disappears.</li> </ul>
<ul style="list-style-type: none"> <li>• <b>Remove one ECG module</b></li> </ul>	<ul style="list-style-type: none"> <li>• al. area</li> </ul>	There are two ECG modules in the system.	<ul style="list-style-type: none"> <li>• Remove one ECG module.</li> </ul>
<ul style="list-style-type: none"> <li>• <b>RR (Imped) High / RR (Imped) Low</b></li> </ul>	<ul style="list-style-type: none"> <li>• al. area</li> </ul>	Measurement values are equal to or outside the alarm limits.	<ul style="list-style-type: none"> <li>• Check the patient status.</li> <li>• Adjust alarm limits if necessary.</li> </ul>
<ul style="list-style-type: none"> <li>• <b>Small resp curve</b></li> </ul>	<ul style="list-style-type: none"> <li>• param.</li> </ul>	Signal amplitude < 0.4 ohm.	<ul style="list-style-type: none"> <li>• Check the patient status.</li> <li>• Check electrode placement.</li> <li>• Change or move electrodes.</li> </ul>

## Messages related to SpO₂ measurement

For information regarding alarm priorities and escalation times, see the supplemental information manual.

Make sure you are familiar with the generic layout of the screen. This will help you identify where on screen the following messages appear. The message location is indicated with the following abbreviations:

- al. area = alarm area
- param. = parameter window
- report = report view
- wavef. = waveform area

Message	Location	Explanation	What to do
<ul style="list-style-type: none"> <li>• <b>Artifact</b></li> </ul>	<ul style="list-style-type: none"> <li>• param.</li> </ul>	Artifact detected.	<ul style="list-style-type: none"> <li>• Check sensor contact.</li> <li>• Reposition/replace sensor.</li> <li>• Request the patient to remain still.</li> </ul>
<ul style="list-style-type: none"> <li>• <b>Check device</b></li> </ul>	<ul style="list-style-type: none"> <li>• param.</li> </ul>	The acquisition module has failed.	<ul style="list-style-type: none"> <li>• Replace the acquisition module.</li> </ul>
<ul style="list-style-type: none"> <li>• <b>Check Ext device</b></li> </ul>	<ul style="list-style-type: none"> <li>• param.</li> </ul>	Interfaced device should be checked.	<ul style="list-style-type: none"> <li>• Check the interfaced device.</li> <li>• If the problem persists, contact authorized service personnel.</li> </ul>
<ul style="list-style-type: none"> <li>• <b>Check probe</b></li> </ul>	<ul style="list-style-type: none"> <li>• param.</li> </ul>	There is no detectable SpO ₂ signal, the sensor is faulty or is detached from the patient.	<ul style="list-style-type: none"> <li>• Check the sensor and connections.</li> </ul>

Message	Location	Explanation	What to do
<ul style="list-style-type: none"> <li>• <b>Check SpO2 probe / Check SpO2(2) probe</b></li> </ul>	<ul style="list-style-type: none"> <li>• al. area</li> </ul>	There is no detectable SpO ₂ signal, the sensor is faulty or is detached from the patient.	<ul style="list-style-type: none"> <li>• Check the sensor and connections.</li> </ul>
<ul style="list-style-type: none"> <li>• <b>Connecting</b></li> </ul>	<ul style="list-style-type: none"> <li>• param.</li> </ul>	Connection to the interfaced device is being established.	<ul style="list-style-type: none"> <li>• No action required.</li> </ul>
<ul style="list-style-type: none"> <li>• <b>Faulty probe</b></li> </ul>	<ul style="list-style-type: none"> <li>• param.</li> </ul>	The sensor has failed.	<ul style="list-style-type: none"> <li>• Replace the sensor.</li> </ul>
<ul style="list-style-type: none"> <li>• <b>Identical SpO2 modules</b></li> </ul>	<ul style="list-style-type: none"> <li>• al. area</li> </ul>	There are two or more identical SpO ₂ modules in the system.	<ul style="list-style-type: none"> <li>• Remove all but one SpO₂ module.</li> </ul>
<ul style="list-style-type: none"> <li>• <b>Incompatible probe</b></li> </ul>	<ul style="list-style-type: none"> <li>• param.</li> </ul>	The sensor is not compatible.	<ul style="list-style-type: none"> <li>• Replace the sensor. See the supplemental information manual.</li> <li>• If the problem persists, contact authorized service personnel.</li> </ul>
<ul style="list-style-type: none"> <li>• <b>Incompatible SpO2 probe / Incompatible SpO2(2) probe</b></li> </ul>	<ul style="list-style-type: none"> <li>• al. area</li> </ul>	The sensor is not compatible.	<ul style="list-style-type: none"> <li>• Replace the sensor. See the supplemental information manual.</li> <li>• If the problem persists, contact authorized service personnel.</li> </ul>
<ul style="list-style-type: none"> <li>• <b>Interference</b></li> </ul>	<ul style="list-style-type: none"> <li>• param.</li> </ul>	The measurement is disturbed.	<ul style="list-style-type: none"> <li>• Check the sensor.</li> </ul>
<ul style="list-style-type: none"> <li>• <b>Learning</b></li> </ul>	<ul style="list-style-type: none"> <li>• param.</li> </ul>	SpO ₂ algorithm is in learning phase.	<ul style="list-style-type: none"> <li>• No action required.</li> </ul>
<ul style="list-style-type: none"> <li>• <b>Low battery</b></li> </ul>	<ul style="list-style-type: none"> <li>• param.</li> </ul>	The interfaced device has low battery charge.	<ul style="list-style-type: none"> <li>• Check the interfaced device.</li> <li>• If the problem persists, contact authorized service personnel.</li> </ul>
<ul style="list-style-type: none"> <li>• <b>Low perfusion</b></li> </ul>	<ul style="list-style-type: none"> <li>• param.</li> </ul>	Low perfusion at the measurement point.	<ul style="list-style-type: none"> <li>• Check the sensor and sensor positioning.</li> <li>• Relocate the sensor to a better measurement site, if possible.</li> <li>• Make sure the patient is not shivering.</li> </ul>
<ul style="list-style-type: none"> <li>• <b>Low signal</b></li> </ul>	<ul style="list-style-type: none"> <li>• param.</li> </ul>	The quality of the signal is questionable.	<ul style="list-style-type: none"> <li>• Check the sensor placement and the patient status.</li> </ul>
<ul style="list-style-type: none"> <li>• <b>Low signal quality</b></li> </ul>	<ul style="list-style-type: none"> <li>• param.</li> </ul>	The quality of the signal is questionable.	<ul style="list-style-type: none"> <li>• Check the sensor and sensor positioning.</li> <li>• Relocate the sensor to a better measurement site, if possible.</li> <li>• Make sure the patient is not shivering.</li> </ul>
<ul style="list-style-type: none"> <li>• <b>Motion detected</b></li> </ul>	<ul style="list-style-type: none"> <li>• param.</li> </ul>	Patient movement detected.	<ul style="list-style-type: none"> <li>• Reposition sensor.</li> </ul>

Message	Location	Explanation	What to do
<ul style="list-style-type: none"> <li><b>No ext device</b></li> </ul>	<ul style="list-style-type: none"> <li>param.</li> </ul>	Interfaced device should be checked.	<ul style="list-style-type: none"> <li>Check the interfaced device.</li> <li>If the problem persists, contact authorized service personnel.</li> </ul>
<ul style="list-style-type: none"> <li><b>No probe</b></li> </ul>	<ul style="list-style-type: none"> <li>param.</li> </ul>	Sensor is not connected to the acquisition module.	<ul style="list-style-type: none"> <li>Check connection between the sensor and the acquisition module.</li> </ul>
<ul style="list-style-type: none"> <li><b>No pulse</b></li> </ul>	<ul style="list-style-type: none"> <li>param.</li> </ul>	Pulse signal is poor.	<ul style="list-style-type: none"> <li>Try other measurement sites.</li> </ul>
<ul style="list-style-type: none"> <li><b>No SpO2 probe / No SpO2(2) probe</b></li> </ul>	<ul style="list-style-type: none"> <li>al. area</li> </ul>	Sensor is not connected to the acquisition module.	<ul style="list-style-type: none"> <li>Check connection between the sensor and the acquisition module.</li> </ul>
<ul style="list-style-type: none"> <li><b>No SpO2 pulse / No SpO2(2) pulse</b></li> </ul>	<ul style="list-style-type: none"> <li>al. area</li> </ul>	Pulse signal is poor.	<ul style="list-style-type: none"> <li>Try other measurement sites.</li> </ul>
<ul style="list-style-type: none"> <li><b>PR(SpO2) high / PR(SpO2) low</b></li> </ul>	<ul style="list-style-type: none"> <li>al. area</li> </ul>	Measurement values are equal to or outside the alarm limits.	<ul style="list-style-type: none"> <li>Check the patient status.</li> <li>Adjust alarm limits if necessary.</li> </ul>
<ul style="list-style-type: none"> <li><b>Probe off</b></li> </ul>	<ul style="list-style-type: none"> <li>param.</li> </ul>	The sensor may be defective.	<ul style="list-style-type: none"> <li>Check the patient status.</li> <li>Reposition the SpO₂ sensor.</li> <li>Replace the SpO₂ sensor.</li> </ul>
<ul style="list-style-type: none"> <li><b>Pulse search</b></li> </ul>	<ul style="list-style-type: none"> <li>param.</li> </ul>	Defective or damaged sensor or cable. Sensor is off of the patient. Detection of a repeatable pulse has stopped.	<ul style="list-style-type: none"> <li>Check the sensor and cable.</li> <li>Reposition or replace sensor.</li> </ul>
<ul style="list-style-type: none"> <li><b>SpO2 alarm setup changed</b></li> </ul>	<ul style="list-style-type: none"> <li>al. area</li> </ul>	Acquisition module has been moved to another channel and the alarm limits or the alarm on/off status of this new channel are different from the previous channel.	<ul style="list-style-type: none"> <li>You can remove the message from the screen with the pause audio key.</li> </ul>
<ul style="list-style-type: none"> <li><b>SpO2 faulty probe / SpO2(2) faulty probe</b></li> </ul>	<ul style="list-style-type: none"> <li>al. area</li> </ul>	The sensor has failed.	<ul style="list-style-type: none"> <li>Replace the sensor.</li> </ul>
<ul style="list-style-type: none"> <li><b>SpO2 high / SpO2 low</b></li> <li><b>SpO2(2) high / SpO2(2) low</b></li> </ul>	<ul style="list-style-type: none"> <li>al. area</li> </ul>	Measurement values are equal to or outside the alarm limits.	<ul style="list-style-type: none"> <li>Check the patient status.</li> <li>Adjust alarm limits if necessary.</li> </ul>
<ul style="list-style-type: none"> <li><b>SpO2 measurement removed</b></li> </ul>	<ul style="list-style-type: none"> <li>al. area</li> </ul>	A secondary SpO ₂ source becomes the primary source as a result of removing PDM, PSM, or TRAM.  Also when the TRAM cable is disconnected.	<ul style="list-style-type: none"> <li>Connect a module to the same channel.</li> <li>Connect the TRAM module and cable.</li> </ul>
<ul style="list-style-type: none"> <li><b>SpO2 probe off / SpO2(2) probe off</b></li> </ul>	<ul style="list-style-type: none"> <li>al. area</li> </ul>	The finger or earlobe may be too thin or the sensor is off the patient.	<ul style="list-style-type: none"> <li>Check the patient status.</li> <li>Reposition the SpO₂ sensor.</li> <li>Replace the SpO₂ sensor.</li> </ul>

Message	Location	Explanation	What to do
<ul style="list-style-type: none"> <li><b>Wrong cable</b></li> </ul>	<ul style="list-style-type: none"> <li>param.</li> </ul>	You have connected a MasimoSet cable to the PDM Nellcor, or a Nellcor OxiMax cable to the PDM Masimo.	<ul style="list-style-type: none"> <li>Check and use the correct cable.</li> </ul>
<ul style="list-style-type: none"> <li><b>Wrong cable. Use Masimo Set</b></li> </ul>	<ul style="list-style-type: none"> <li>al. area,</li> <li>param.</li> </ul>	You have connected a Nellcor OxiMax cable to the PDM Masimo.	<ul style="list-style-type: none"> <li>Use a MasimoSet cable.</li> </ul>
<ul style="list-style-type: none"> <li><b>Wrong cable. Use Nellcor OxiMax</b></li> </ul>	<ul style="list-style-type: none"> <li>al. area,</li> <li>param.</li> </ul>	You have connected a MasimoSet cable to the PDM Nellcor.	<ul style="list-style-type: none"> <li>Use a Nellcor OxiMax cable.</li> </ul>

## Messages related to NIBP measurement

For information regarding alarm priorities and escalation times, see the supplemental information manual.

Make sure you are familiar with the generic layout of the screen. This will help you identify where on screen the following messages appear. The message location is indicated with the following abbreviations:

- al. area = alarm area
- param. = parameter window
- report = report view
- wavef. = waveform area

Message	Location	Explanation	What to do
<ul style="list-style-type: none"> <li><b>Air leakage</b></li> </ul>	<ul style="list-style-type: none"> <li>param.</li> </ul>	Loose cuff or cuff hose.	<ul style="list-style-type: none"> <li>Check the cuff and cuff hose.</li> </ul>
<ul style="list-style-type: none"> <li><b>Artifacts</b></li> </ul>	<ul style="list-style-type: none"> <li>param.</li> </ul>	Measurement is disturbed by artifact (e.g. patient movement, shivering, deep breathing, marked arrhythmia or irregular beats).	<ul style="list-style-type: none"> <li>Calm the patient and retry.</li> </ul>
<ul style="list-style-type: none"> <li><b>Calibrated</b></li> </ul>	<ul style="list-style-type: none"> <li>param.</li> </ul>	Channel calibrated successfully.	<ul style="list-style-type: none"> <li>Wait until the message disappears before starting a measurement.</li> </ul>
<ul style="list-style-type: none"> <li><b>Calibrating</b></li> </ul>	<ul style="list-style-type: none"> <li>param.</li> </ul>	Calibration of a channel is in progress.	<ul style="list-style-type: none"> <li>No action required.</li> </ul>
<ul style="list-style-type: none"> <li><b>Calibration switch ON</b></li> </ul>	<ul style="list-style-type: none"> <li>param.</li> </ul>	The calibration switch is on.	<ul style="list-style-type: none"> <li>Contact authorized service personnel.</li> </ul>
<ul style="list-style-type: none"> <li><b>Call service</b></li> </ul>	<ul style="list-style-type: none"> <li>param.</li> </ul>	Technical fault.	<ul style="list-style-type: none"> <li>Contact authorized service personnel.</li> </ul>



Message	Location	Explanation	What to do
<ul style="list-style-type: none"> <li>• <b>Call service: Error x</b></li> <li>• where x = 0 - 99</li> </ul>	<ul style="list-style-type: none"> <li>• param.</li> </ul>	0 = RAM failure 1 = ROM checksum failure 2 = +15V failure 3 = -15V failure 6 = ADC error 7 = Watchdog time too short 8 = Watchdog time too long 9 = Watchdog activated 10 = EEPROM checksum error 11 = Autozero range exceeded 12 = Communication watchdog activated 13 = Not in use 14 = Too early autocycle start	<ul style="list-style-type: none"> <li>• Contact authorized service personnel.</li> </ul>
<ul style="list-style-type: none"> <li>• <b>Check NIBP</b></li> </ul>	<ul style="list-style-type: none"> <li>• al. area</li> </ul>	Systolic and/or diastolic results missing.	<ul style="list-style-type: none"> <li>• Check the patient status.</li> <li>• Check NIBP cuff and hoses.</li> <li>• Repeat the measurement.</li> </ul>
<ul style="list-style-type: none"> <li>• <b>Control measurement</b></li> </ul>	<ul style="list-style-type: none"> <li>• al. area</li> </ul>	Pressure alarm limit exceeded.	<ul style="list-style-type: none"> <li>• Allow measurement to complete.</li> <li>• Check the patient status.</li> </ul>
<ul style="list-style-type: none"> <li>• <b>Cuff occlusion</b></li> </ul>	<ul style="list-style-type: none"> <li>• param.</li> </ul>	Occlusion during measurement or overpressured cuff.	<ul style="list-style-type: none"> <li>• Check the cuff.</li> </ul>
<ul style="list-style-type: none"> <li>• <b>Cuff loose</b></li> </ul>	<ul style="list-style-type: none"> <li>• param.</li> </ul>	Loose cuff or cuff hose.	<ul style="list-style-type: none"> <li>• Check the cuff and cuff hose.</li> </ul>
<ul style="list-style-type: none"> <li>• <b>Cuff overpressure</b></li> </ul>	<ul style="list-style-type: none"> <li>• param.</li> </ul>	NIBP cuff is squeezed during measurement.	<ul style="list-style-type: none"> <li>• Check NIBP cuff and hoses.</li> <li>• Repeat the measurement.</li> </ul>
<ul style="list-style-type: none"> <li>• <b>Incorrect infl. limits</b></li> </ul>	<ul style="list-style-type: none"> <li>• param.</li> </ul>	Adult or child cuff is used, but the selected infant mode restricts the inflation pressure too low to be able to measure the blood pressure.	<ul style="list-style-type: none"> <li>• Adjust NIBP setup.</li> </ul>
<ul style="list-style-type: none"> <li>• <b>Long meas. time</b></li> </ul>	<ul style="list-style-type: none"> <li>• param.</li> </ul>	The measurement time is long. The triggering values vary according to the module and inflation limits in use: <ul style="list-style-type: none"> <li>• PSM: &gt;2 min for adult/ child, 75 s to 80 s for infant</li> <li>• PDM: &gt;2 min for adult/ child, 85 s for infant</li> <li>• TRAM: &lt;3 min for adult/ child, 90 s for infant</li> </ul>	<ul style="list-style-type: none"> <li>• Check the patient status.</li> <li>• Check the cuff and hose connections.</li> <li>• Restart the measurement.</li> <li>• If the problem persists, contact authorized service personnel.</li> </ul>
<ul style="list-style-type: none"> <li>• <b>NIBP air leakage / NIBP manual</b></li> </ul>	<ul style="list-style-type: none"> <li>• al. area</li> </ul>	Loose cuff or cuff hose.	<ul style="list-style-type: none"> <li>• Check the cuff and cuff hose.</li> </ul>

Message	Location	Explanation	What to do
<ul style="list-style-type: none"> <li>• <b>NIBP cuff occlusion</b></li> </ul>	<ul style="list-style-type: none"> <li>• al. area</li> </ul>	Occlusion during measurement or overpressured cuff.	<ul style="list-style-type: none"> <li>• Check the cuff.</li> </ul>
<ul style="list-style-type: none"> <li>• <b>NIBP cuff loose</b></li> </ul>	<ul style="list-style-type: none"> <li>• al. area</li> </ul>	Loose cuff or cuff hose.	<ul style="list-style-type: none"> <li>• Check the cuff and cuff hose.</li> </ul>
<ul style="list-style-type: none"> <li>• <b>NIBP Dia high / NIBP Dia low</b></li> <li>• <b>NIBP Mean high / NIBP Mean low</b></li> <li>• <b>NIBP Sys high / NIBP Sys low</b></li> </ul>	<ul style="list-style-type: none"> <li>• al. area, param.</li> </ul>	Measurement values are equal to or outside the alarm limits.	<ul style="list-style-type: none"> <li>• Check the patient status.</li> <li>• Adjust alarm limits if necessary.</li> </ul>
<ul style="list-style-type: none"> <li>• <b>NIBP manual</b></li> </ul>	<ul style="list-style-type: none"> <li>• al. area</li> </ul>	Loose cuff or cuff hose.	<ul style="list-style-type: none"> <li>• Check the cuff and cuff hose.</li> </ul>
<ul style="list-style-type: none"> <li>• <b>NIBP measurement removed</b></li> </ul>	<ul style="list-style-type: none"> <li>• al. area</li> </ul>	Acquisition module has lost NIBP communication.	<ul style="list-style-type: none"> <li>• Remove the module and then reconnect it.</li> <li>• Replace the module.</li> <li>• If the problem persists, contact authorized service personnel.</li> </ul>
<ul style="list-style-type: none"> <li>• <b>Protect calibration</b></li> </ul>	<ul style="list-style-type: none"> <li>• param.</li> </ul>	Calibration is not protected.	<ul style="list-style-type: none"> <li>• Contact authorized service personnel.</li> </ul>
<ul style="list-style-type: none"> <li>• <b>Select cuff size</b></li> </ul>	<ul style="list-style-type: none"> <li>• al. area, param.</li> </ul>	Cuff does not have an automatically detectable cuff ID.	<ul style="list-style-type: none"> <li>• Select a cuff size from the NIBP setup menu.</li> </ul>
<ul style="list-style-type: none"> <li>• <b>Select inflation limits</b></li> </ul>	<ul style="list-style-type: none"> <li>• al. area, param.</li> </ul>	Cuff does not have an automatically detectable cuff ID.	<ul style="list-style-type: none"> <li>• Select an inflation limit from the NIBP setup menu.</li> </ul>
<ul style="list-style-type: none"> <li>• <b>Unable to meas. Dia</b></li> </ul>	<ul style="list-style-type: none"> <li>• param.</li> </ul>	Accurate diastolic pressure is difficult to measure because of artifacts, weak pulsation etc.	<ul style="list-style-type: none"> <li>• Assess the patient and check inflation limits.</li> <li>• Perform a new measurement.</li> </ul>
<ul style="list-style-type: none"> <li>• <b>Unable to meas. Sys</b></li> </ul>	<ul style="list-style-type: none"> <li>• param.</li> </ul>	Systolic pressure probably higher than maximum inflation pressure or artifacts interfere in the systolic area.	<ul style="list-style-type: none"> <li>• Assess the patient and check the cuff placement.</li> <li>• Perform a new measurement.</li> </ul>
<ul style="list-style-type: none"> <li>• <b>Unstable zero press.</b></li> </ul>	<ul style="list-style-type: none"> <li>• param.</li> </ul>	Pressure is unstable at start of the NIBP measurement.	<ul style="list-style-type: none"> <li>• Check the patient status.</li> <li>• Check hose and cuff position.</li> <li>• Repeat the measurement.</li> <li>• If the problem persists, contact authorized service personnel.</li> </ul>
<ul style="list-style-type: none"> <li>• <b>Weak pulsation</b></li> </ul>	<ul style="list-style-type: none"> <li>• param.</li> </ul>	Weak or unstable oscillation signal.	<ul style="list-style-type: none"> <li>• Check the patient status.</li> <li>• Reposition the cuff.</li> <li>• Repeat the measurement.</li> </ul>

Message	Location	Explanation	What to do
<ul style="list-style-type: none"> <li>• <b>Zero failure</b></li> </ul>	<ul style="list-style-type: none"> <li>• param.</li> </ul>	Zeroing has failed.	<ul style="list-style-type: none"> <li>• Check the patient's pressure by alternative means.</li> <li>• Replace the module.</li> <li>• If the problem persists, contact authorized service personnel.</li> </ul>
<ul style="list-style-type: none"> <li>• <b>Zeroing</b></li> </ul>	<ul style="list-style-type: none"> <li>• param.</li> </ul>	Zeroing is in progress.	<ul style="list-style-type: none"> <li>• Wait until the zeroing is completed.</li> </ul>
<ul style="list-style-type: none"> <li>• <b>Zero OK</b></li> </ul>	<ul style="list-style-type: none"> <li>• param.</li> </ul>	Zeroing was successful.	<ul style="list-style-type: none"> <li>• No action required.</li> </ul>

## Messages related to invasive pressures measurement

For information regarding alarm priorities and escalation times, see the supplemental information manual.

Make sure you are familiar with the generic layout of the screen. This will help you identify where on screen the following messages appear. The message location is indicated with the following abbreviations:

- al. area = alarm area
- param. = parameter window
- report = report view
- wavef. = waveform area

Message	Location	Explanation	What to do
<ul style="list-style-type: none"> <li>• <b>&gt; 320 mmHg or &gt; 43 kPa</b></li> </ul>	<ul style="list-style-type: none"> <li>• param.</li> </ul>	<p>Measurement is over range, or the sensor is faulty.</p> <p>If you pre-zero a line with the stopcock closed, it creates a high fluid bag pressure and triggers this message. In this case, you can acknowledge the alarm with the pause audio key.</p>	<ul style="list-style-type: none"> <li>• Check the patient's pressure by alternative means.</li> <li>• Check the cable and connections.</li> <li>• Rezero the transducer.</li> <li>• Replace the sensor.</li> <li>• Replace the transducer.</li> <li>• Replace the module.</li> <li>• If the problem persists, contact authorized service personnel.</li> </ul>
<ul style="list-style-type: none"> <li>• <b>&lt; -40 mmHg or &lt; -5 kPa</b></li> </ul>	<ul style="list-style-type: none"> <li>• param.</li> </ul>	<p>Measurement is under range, or the sensor is faulty.</p>	<ul style="list-style-type: none"> <li>• Check the patient's pressure by alternative means.</li> <li>• Check the cable and connections.</li> <li>• Rezero the transducer.</li> <li>• Replace the sensor.</li> <li>• Replace the transducer.</li> </ul>

Message	Location	Explanation	What to do
			<ul style="list-style-type: none"> <li>• Replace the module.</li> <li>• If the problem persists, contact authorized service personnel.</li> </ul>
<ul style="list-style-type: none"> <li>• <b>ABP disconnect</b></li> </ul>	<ul style="list-style-type: none"> <li>• al. area</li> </ul>	Invasive pressure line is disconnected.	<ul style="list-style-type: none"> <li>• Check the patient status.</li> <li>• Check connections.</li> <li>• If pressure drops because of zeroing, perform the zeroing process.</li> </ul>
<ul style="list-style-type: none"> <li>• <b>ABP sys high / ABP sys low</b></li> <li>• <b>ABP mean high / ABP mean low</b></li> <li>• <b>ABP dia high / ABP dia low</b></li> </ul>	<ul style="list-style-type: none"> <li>• al. area</li> </ul>	Measurement values are equal to or outside the alarm limits.	<ul style="list-style-type: none"> <li>• Check the patient status.</li> <li>• Adjust alarm limits if necessary.</li> </ul>
<ul style="list-style-type: none"> <li>• <b>Art disconnect</b></li> </ul>	<ul style="list-style-type: none"> <li>• al. area</li> </ul>	Invasive pressure line is disconnected.	<ul style="list-style-type: none"> <li>• Check the patient status.</li> <li>• Check connections.</li> <li>• If pressure drops because of zeroing, perform the zeroing process.</li> </ul>
<ul style="list-style-type: none"> <li>• <b>Art sys high / Art sys low</b></li> <li>• <b>Art mean high / Art mean low</b></li> <li>• <b>Art dia high / Art dia low</b></li> </ul>	<ul style="list-style-type: none"> <li>• al. area</li> </ul>	Measurement values are equal to or outside the alarm limits.	<ul style="list-style-type: none"> <li>• Check the patient status.</li> <li>• Adjust alarm limits if necessary.</li> </ul>
<ul style="list-style-type: none"> <li>• <b>Artifact</b></li> </ul>	<ul style="list-style-type: none"> <li>• param.</li> </ul>	<p>If Smart BP is enabled, this is normal behavior when zeroing, flushing, or sampling is performed.</p> <p>If Smart BP is not enabled, this message indicates that the measurement is disturbed by artifact.</p>	<ul style="list-style-type: none"> <li>• Check the patient status.</li> <li>• Check cable contact.</li> <li>• Minimize tubing length.</li> <li>• Rezero the transducer.</li> </ul>
<ul style="list-style-type: none"> <li>• <b>Calibrated</b></li> </ul>	<ul style="list-style-type: none"> <li>• param.</li> </ul>	Channel calibrated successfully.	<ul style="list-style-type: none"> <li>• Wait until the message disappears before starting a measurement.</li> </ul>
<ul style="list-style-type: none"> <li>• <b>Calibrating</b></li> </ul>	<ul style="list-style-type: none"> <li>• param.</li> </ul>	Calibration of a channel is in progress.	<ul style="list-style-type: none"> <li>• No action required.</li> </ul>
<ul style="list-style-type: none"> <li>• <b>Calibration failed</b></li> </ul>	<ul style="list-style-type: none"> <li>• param.</li> </ul>	Unsuccessful calibration.	<ul style="list-style-type: none"> <li>• Check the connections and recalibrate.</li> </ul>
<ul style="list-style-type: none"> <li>• <b>CPP high / CPP low</b></li> </ul>	<ul style="list-style-type: none"> <li>• al. area</li> </ul>	Measurement values are equal to or outside the alarm limits.	<ul style="list-style-type: none"> <li>• Check the patient status.</li> <li>• Adjust alarm limits if necessary.</li> </ul>

Message	Location	Explanation	What to do
<ul style="list-style-type: none"> <li>• <b>CVP sys high / CVP sys low</b></li> <li>• <b>CVP mean high / CVP mean low</b></li> <li>• <b>CVP dia high / CVP dia low</b></li> </ul>	<ul style="list-style-type: none"> <li>• al. area</li> </ul>	Measurement values are equal to or outside the alarm limits.	<ul style="list-style-type: none"> <li>• Check the patient status.</li> <li>• Adjust alarm limits if necessary.</li> </ul>
<ul style="list-style-type: none"> <li>• <b>Disconnected</b></li> </ul>	<ul style="list-style-type: none"> <li>• param.</li> </ul>	Pressure is below physiological detection threshold.	<ul style="list-style-type: none"> <li>• Check the patient status.</li> <li>• Check the cable and connections.</li> <li>• If pressure drops because of zeroing, perform the zeroing process.</li> </ul>
<ul style="list-style-type: none"> <li>• <b>Fem disconnect</b></li> </ul>	<ul style="list-style-type: none"> <li>• al. area</li> </ul>	Invasive pressure line is disconnected.	<ul style="list-style-type: none"> <li>• Check the patient status.</li> <li>• Check connections.</li> <li>• If pressure drops because of zeroing, perform the zeroing process.</li> </ul>
<ul style="list-style-type: none"> <li>• <b>Fem sys high / Fem sys low</b></li> <li>• <b>Fem mean high / Fem mean low</b></li> <li>• <b>Fem dia high / Fem dia low</b></li> </ul>	<ul style="list-style-type: none"> <li>• al. area</li> </ul>	Measurement values are equal to or outside the alarm limits.	<ul style="list-style-type: none"> <li>• Check the patient status.</li> <li>• Adjust alarm limits if necessary.</li> </ul>
<ul style="list-style-type: none"> <li>• <b>FemV sys high / FemV sys low</b></li> <li>• <b>FemV mean high / FemV mean low</b></li> <li>• <b>FemV dia high / FemV dia low</b></li> </ul>	<ul style="list-style-type: none"> <li>• al. area</li> </ul>	Measurement values are equal to or outside the alarm limits.	<ul style="list-style-type: none"> <li>• Check the patient status.</li> <li>• Adjust alarm limits if necessary.</li> </ul>
<ul style="list-style-type: none"> <li>• <b>ICP sys high / ICP sys low</b></li> <li>• <b>ICP mean high / ICP mean low</b></li> <li>• <b>ICP dia high / ICP dia low</b></li> </ul>	<ul style="list-style-type: none"> <li>• al. area</li> </ul>	Measurement values are equal to or outside the alarm limits.	<ul style="list-style-type: none"> <li>• Check the patient status.</li> <li>• Adjust alarm limits if necessary.</li> </ul>
<ul style="list-style-type: none"> <li>• <b>Identical IP modules</b></li> <li>• <b>Identical IP2 modules</b></li> </ul>	<ul style="list-style-type: none"> <li>• al. area</li> </ul>	There are two or more IP modules in the system.	<ul style="list-style-type: none"> <li>• Remove all but one IP module.</li> </ul>
<ul style="list-style-type: none"> <li>• <b>Identical IP3 modules to</b></li> <li>• <b>Identical IP8 modules</b></li> </ul>	<ul style="list-style-type: none"> <li>• al. area</li> </ul>	There are two or more IP modules in the system.	<ul style="list-style-type: none"> <li>• Remove all but one IP module.</li> </ul>
<ul style="list-style-type: none"> <li>• <b>Identical IP RAC modules</b></li> </ul>	<ul style="list-style-type: none"> <li>• al. area</li> </ul>	There are two or more IP RAC modules in identical slots in the system.	<ul style="list-style-type: none"> <li>• Remove all but one IP RAC module.</li> </ul>

Message	Location	Explanation	What to do
<ul style="list-style-type: none"> <li>• <b>Identical PP modules</b></li> </ul>	<ul style="list-style-type: none"> <li>• al. area</li> </ul>	There are two or more E-PP modules in the system.	<ul style="list-style-type: none"> <li>• Remove all but one E-PP module.</li> </ul>
<ul style="list-style-type: none"> <li>• <b>Identical PT modules</b></li> </ul>	<ul style="list-style-type: none"> <li>• al. area</li> </ul>	There are two or more E-PT modules in the system.	<ul style="list-style-type: none"> <li>• Remove all but one E-PT module.</li> </ul>
<ul style="list-style-type: none"> <li>• <b>IP module in invalid slot [1, 2, 3, 4]</b></li> </ul>	<ul style="list-style-type: none"> <li>• al. area</li> </ul>	The invasive pressure module is in the wrong module slot.	<ul style="list-style-type: none"> <li>• Insert single parameter pressure module in either slot 3 or 4 of the Tram-Rac 4A housing.</li> </ul>
<ul style="list-style-type: none"> <li>• <b>IP's not zeroed</b></li> </ul>	<ul style="list-style-type: none"> <li>• al. area</li> </ul>	The invasive pressure lines have not been zeroed.	<ul style="list-style-type: none"> <li>• Perform zeroing.</li> </ul>
<ul style="list-style-type: none"> <li>• <b>LAP sys high / LAP sys low</b></li> <li>• <b>LAP mean high / LAP mean low</b></li> <li>• <b>LAP dia high / LAP dia low</b></li> </ul>	<ul style="list-style-type: none"> <li>• al. area</li> </ul>	Measurement values are equal to or outside the alarm limits.	<ul style="list-style-type: none"> <li>• Check the patient status.</li> <li>• Adjust alarm limits if necessary.</li> </ul>
<ul style="list-style-type: none"> <li>• <b>No P1 transducer to</b></li> <li>• <b>No P8 transducer</b></li> </ul>	<ul style="list-style-type: none"> <li>• al. area</li> </ul>	No transducer connected to the channel indicated in the message, or the sensor is faulty.	<ul style="list-style-type: none"> <li>• Connect a transducer.</li> <li>• Check the cable and connections.</li> <li>• Replace the sensor.</li> <li>• Replace the transducer.</li> <li>• If the problem persists, contact authorized service personnel.</li> </ul>
<ul style="list-style-type: none"> <li>• <b>P1 over range to P8 over range</b></li> <li>• <b>P1 under range to P8 under rang</b></li> </ul>	<ul style="list-style-type: none"> <li>• al. area</li> </ul>	The measurement value is over or under range, or the sensor is faulty.	<ul style="list-style-type: none"> <li>• Check the patient status.</li> <li>• Check the cables.</li> <li>• Rezero the transducer.</li> <li>• Replace the sensor.</li> <li>• Replace the transducer.</li> <li>• Replace the module.</li> <li>• If the problem persists, contact authorized service personnel.</li> </ul>
<ul style="list-style-type: none"> <li>• <b>P1 standby to P8 standby</b></li> </ul>	<ul style="list-style-type: none"> <li>• param.</li> </ul>	The IP channel has been set to standby.	<ul style="list-style-type: none"> <li>• Reactivate the channel by selecting <b>Activate P1</b> to <b>Activate P8</b>.</li> </ul>

Message	Location	Explanation	What to do
<ul style="list-style-type: none"> <li>• <i>P1 sys high / P1 sys low</i></li> <li>• <i>P1 mean high / P1 mean low</i></li> <li>• <i>P1 dia high / P1 dia low</i></li> </ul> to <ul style="list-style-type: none"> <li>• <i>P8 sys high / P8 sys low</i></li> <li>• <i>P8 mean high / P8 mean low</i></li> <li>• <i>P8 dia high / P8 dia low</i></li> </ul>	<ul style="list-style-type: none"> <li>• al. area</li> </ul>	Measurement values are equal to or outside the alarm limits.	<ul style="list-style-type: none"> <li>• Check the patient status.</li> <li>• Adjust alarm limits if necessary.</li> </ul>
<ul style="list-style-type: none"> <li>• <i>P1 zeroing failed</i></li> <li>• <i>P8 zeroing failed</i></li> </ul>	<ul style="list-style-type: none"> <li>• param.</li> </ul>	The channel has not been zeroed successfully.	<ul style="list-style-type: none"> <li>• Repeat the zeroing.</li> </ul>
<ul style="list-style-type: none"> <li>• <i>P7 connected</i></li> </ul>	<ul style="list-style-type: none"> <li>• al. area</li> </ul>	The channel has been connected.	<ul style="list-style-type: none"> <li>• No action required.</li> </ul>
<ul style="list-style-type: none"> <li>• <i>P8 connected</i></li> </ul>	<ul style="list-style-type: none"> <li>• al. area</li> </ul>	The channel has been connected.	<ul style="list-style-type: none"> <li>• No action required.</li> </ul>
<ul style="list-style-type: none"> <li>• <i>PA sys high / PA sys low</i></li> <li>• <i>PA mean high / PA mean low</i></li> <li>• <i>PA dia high / PA dia low</i></li> </ul>	<ul style="list-style-type: none"> <li>• al. area</li> </ul>	Measurement values are equal to or outside the alarm limits.	<ul style="list-style-type: none"> <li>• Check the patient status.</li> <li>• Adjust alarm limits if necessary.</li> </ul>
<ul style="list-style-type: none"> <li>• <i>PR(ABP) high / PR(ABP) low</i></li> <li>• <i>PR(Art) high / PR(Art) low</i></li> <li>• <i>PR(Fem) high / PR(Fem) low</i></li> <li>• <i>PR(UAC) high / PR(UAC) low</i></li> </ul>	<ul style="list-style-type: none"> <li>• al. area</li> </ul>	Measurement values are equal to or outside the alarm limits.	<ul style="list-style-type: none"> <li>• Check the patient status.</li> <li>• Adjust alarm limits if necessary.</li> </ul>
<ul style="list-style-type: none"> <li>• <i>Pressure measurement removed</i></li> </ul>	<ul style="list-style-type: none"> <li>• al. area</li> </ul>	The acquisition module has been removed.	<ul style="list-style-type: none"> <li>• Reconnect if necessary.</li> </ul>
<ul style="list-style-type: none"> <li>• <i>Pressure Sensed</i></li> </ul>	<ul style="list-style-type: none"> <li>• param.</li> </ul>	Pressure has been sensed during zeroing.	<ul style="list-style-type: none"> <li>• Open the venting stopcock to air.</li> </ul>
<ul style="list-style-type: none"> <li>• <i>RAP sys high / RAP sys low</i></li> <li>• <i>RAP mean high / RAP mean low</i></li> <li>• <i>RAP dia high / RAP dia low</i></li> </ul>	<ul style="list-style-type: none"> <li>• al. area</li> </ul>	Measurement values are equal to or outside the alarm limits.	<ul style="list-style-type: none"> <li>• Check the patient status.</li> <li>• Adjust alarm limits if necessary.</li> </ul>

Messages

Message	Location	Explanation	What to do
<ul style="list-style-type: none"> <li>• <b>RVP sys high / RVP sys low</b></li> <li>• <b>RVP mean high / RVP mean low</b></li> <li>• <b>RVP dia high / RVP dia low</b></li> </ul>	<ul style="list-style-type: none"> <li>• al. area</li> </ul>	Measurement values are equal to or outside the alarm limits.	<ul style="list-style-type: none"> <li>• Check the patient status.</li> <li>• Adjust alarm limits if necessary.</li> </ul>
<ul style="list-style-type: none"> <li>• <b>Sensor P1 failed to Sensor P8 failed</b></li> </ul>	<ul style="list-style-type: none"> <li>• al. area</li> </ul>	IP: Faulty or disconnected sensor.	<ul style="list-style-type: none"> <li>• Check the cable and connections.</li> <li>• Replace the transducer.</li> </ul>
<ul style="list-style-type: none"> <li>• <b>Sensor</b></li> </ul>	<ul style="list-style-type: none"> <li>• param.</li> </ul>	IP: Faulty or disconnected sensor.	<ul style="list-style-type: none"> <li>• Check the cable and connections.</li> <li>• Replace the transducer.</li> </ul>
<ul style="list-style-type: none"> <li>• <b>UAC disconnect</b></li> </ul>	<ul style="list-style-type: none"> <li>• al. area</li> </ul>	Invasive pressure line is disconnected.	<ul style="list-style-type: none"> <li>• Check the patient status.</li> <li>• Check connections.</li> <li>• If pressure drops because of zeroing, perform the zeroing process.</li> </ul>
<ul style="list-style-type: none"> <li>• <b>UAC sys high / UAC sys low</b></li> <li>• <b>UAC mean high / UAC mean low</b></li> <li>• <b>UAC dia high / UAC dia low</b></li> </ul>	<ul style="list-style-type: none"> <li>• al. area</li> </ul>	Measurement values are equal to or outside the alarm limits.	<ul style="list-style-type: none"> <li>• Check the patient status.</li> <li>• Adjust alarm limits if necessary.</li> </ul>
<ul style="list-style-type: none"> <li>• <b>UVC sys high / UVC sys low</b></li> <li>• <b>UVC mean high / UVC mean low</b></li> <li>• <b>UVC dia high / UVC dia low</b></li> </ul>	<ul style="list-style-type: none"> <li>• al. area</li> </ul>	Measurement values are equal to or outside the alarm limits.	<ul style="list-style-type: none"> <li>• Check the patient status.</li> <li>• Adjust alarm limits if necessary.</li> </ul>
<ul style="list-style-type: none"> <li>• <b>Zero adj &gt;100 mmHg</b></li> </ul>	<ul style="list-style-type: none"> <li>• param.</li> </ul>	IP channel zeroed to over 100 mmHg pressure.	<ul style="list-style-type: none"> <li>• Repeat the transducer zeroing.</li> <li>• Replace the sensor.</li> <li>• Replace the transducer.</li> <li>• Replace the module.</li> <li>• If the problem persists, contact authorized service personnel.</li> </ul>
<ul style="list-style-type: none"> <li>• <b>Zeroed</b></li> </ul>	<ul style="list-style-type: none"> <li>• param.</li> </ul>	Zeroing was successful.	<ul style="list-style-type: none"> <li>• No action required.</li> </ul> <p>Message is automatically removed after 10 seconds.</p>



Message	Location	Explanation	What to do
<ul style="list-style-type: none"> <li>• <b>Zeroing</b></li> </ul>	<ul style="list-style-type: none"> <li>• param.</li> </ul>	IP channel is currently being zeroed.	<ul style="list-style-type: none"> <li>• No action required.</li> </ul> Message is automatically removed and replaced with the zeroing results after completion.
<ul style="list-style-type: none"> <li>• <b>Zero ICP separately</b></li> </ul>	<ul style="list-style-type: none"> <li>• al. area</li> </ul>	The ICP channel must be zeroed separately from all other invasive pressures.	<ul style="list-style-type: none"> <li>• Zero the channel using the <b>Zero</b> option found under the ICP channel setup menu.</li> </ul>

## Messages related to temperature measurement

For information regarding alarm priorities and escalation times, see the supplemental information manual.

Make sure you are familiar with the generic layout of the screen. This will help you identify where on screen the following messages appear. The message location is indicated with the following abbreviations:

- al. area = alarm area
- param. = parameter window
- report = report view
- wavef. = waveform area

Message	Location	Explanation	What to do
<ul style="list-style-type: none"> <li>• <b>Calibration check</b></li> </ul>	<ul style="list-style-type: none"> <li>• param.</li> </ul>	There is a 0.1°C difference between the measured temperature and the internal calibration for the indicated channel.	<ul style="list-style-type: none"> <li>• Change the cable.</li> <li>• Change the module.</li> <li>• If the problem persists, contact authorized service personnel.</li> </ul>
<ul style="list-style-type: none"> <li>• <b>Calibration fail</b></li> </ul>	<ul style="list-style-type: none"> <li>• param.</li> </ul>	Calibration on the indicated channel failed.	<ul style="list-style-type: none"> <li>• Check connections.</li> <li>• Replace the transducer.</li> <li>• If the problem persists, contact authorized service personnel.</li> </ul>
<ul style="list-style-type: none"> <li>• <b>Identical temperature modules</b></li> </ul>	<ul style="list-style-type: none"> <li>• al. area</li> </ul>	There are two or more identical temperature modules in the system.	<ul style="list-style-type: none"> <li>• Remove all but one temperature module.</li> </ul>
<ul style="list-style-type: none"> <li>• <b>No sensor detected</b></li> </ul>	<ul style="list-style-type: none"> <li>• param.</li> </ul>	No sensor detected.	<ul style="list-style-type: none"> <li>• Check the sensor and connections.</li> </ul>
<ul style="list-style-type: none"> <li>• <b>Performing temp test</b></li> </ul>	<ul style="list-style-type: none"> <li>• param.</li> </ul>	Module is calibrating.	<ul style="list-style-type: none"> <li>• No action required.</li> </ul>
<ul style="list-style-type: none"> <li>• <b>T1 Calibration check / T2 Calibration check</b></li> </ul>	<ul style="list-style-type: none"> <li>• al. area</li> </ul>	There is a 0.1°C difference between the measured temperature and the internal calibration for the indicated channel.	<ul style="list-style-type: none"> <li>• Change the cable.</li> <li>• Change the module.</li> <li>• If the problem persists, contact authorized service personnel.</li> </ul>

Message	Location	Explanation	What to do
<ul style="list-style-type: none"> <li>• <b>T1 Calibration fail / T2 Calibration fail / Tblood Calibration fail</b></li> </ul>	<ul style="list-style-type: none"> <li>• al. area</li> </ul>	Calibration on the indicated channel failed.	<ul style="list-style-type: none"> <li>• Check connections.</li> <li>• Replace the transducer.</li> <li>• If the problem persists, contact authorized service personnel.</li> </ul>
<ul style="list-style-type: none"> <li>• <b>T1 high / T1 low</b></li> <li>• <b>T2 high / T2 low</b></li> <li>• <b>T3 high / T3 low</b></li> <li>• <b>T4 high / T4 low</b></li> <li>• <b>Tblood high / Tblood low</b></li> </ul>	<ul style="list-style-type: none"> <li>• al. area</li> </ul>	Measurement values are equal to or outside the alarm limits.	<ul style="list-style-type: none"> <li>• Check the patient status.</li> <li>• Adjust alarm limits if necessary.</li> </ul>
<ul style="list-style-type: none"> <li>• <b>T2-T1 high</b></li> <li>• <b>T4-T3 high</b></li> <li>• <b>Tblood-T1 high</b></li> <li>• <b>Tblood-T3 high</b></li> </ul>	<ul style="list-style-type: none"> <li>• al. area</li> </ul>	Measured delta value is equal to or outside the alarm limits.	<ul style="list-style-type: none"> <li>• Check the patient status.</li> <li>• Adjust alarm limits if necessary.</li> </ul>
<ul style="list-style-type: none"> <li>• <b>T1 temperature error / T2 temperature error / T3 temperature error / T4 temperature error / Tblood temperature error</b></li> </ul>	<ul style="list-style-type: none"> <li>• al. area</li> </ul>	Hardware or calibration test failure in the measurement device.	<ul style="list-style-type: none"> <li>• Change the cable.</li> <li>• Change the module.</li> <li>• If the problem persists, contact authorized service personnel.</li> </ul>
<ul style="list-style-type: none"> <li>• <b>Temperature error</b></li> </ul>	<ul style="list-style-type: none"> <li>• param.</li> </ul>	Hardware or calibration test failure in the measurement device.	<ul style="list-style-type: none"> <li>• Change the cable.</li> <li>• Change the module.</li> <li>• If the problem persists, contact authorized service personnel.</li> </ul>
<ul style="list-style-type: none"> <li>• <b>Temp measurement removed</b></li> </ul>	<ul style="list-style-type: none"> <li>• al. area</li> </ul>	Acquisition module, temperature cable, or temperature probe(s) have been removed.	<ul style="list-style-type: none"> <li>• Check all connections and reconnect as required.</li> </ul>

## Messages related to cardiac output measurement

For information regarding alarm priorities and escalation times, see the supplemental information manual.

Make sure you are familiar with the generic layout of the screen. This will help you identify where on screen the following messages appear. The message location is indicated with the following abbreviations:

- al. area = alarm area
- param. = parameter window
- report = report view
- wavef. = waveform area
- C.O. menu = cardiac output menu, **Measurement** tab

Message	Location	Explanation	What to do
<ul style="list-style-type: none"> <li>• <b>Calibrating</b></li> </ul>	<ul style="list-style-type: none"> <li>• param.</li> </ul>	Calibration is in progress.	<ul style="list-style-type: none"> <li>• No action required.</li> </ul>
<ul style="list-style-type: none"> <li>• <b>Calibration fail</b></li> </ul>	<ul style="list-style-type: none"> <li>• param.</li> </ul>	Unsuccessful calibration.	<ul style="list-style-type: none"> <li>• Authorized service personnel should repeat the calibration procedure.</li> </ul>
<ul style="list-style-type: none"> <li>• <b>CCI high / CCI low</b></li> </ul>	<ul style="list-style-type: none"> <li>• al. area</li> </ul>	Measurement values are equal to or outside the alarm limits.	<ul style="list-style-type: none"> <li>• Check the patient status.</li> <li>• Adjust alarm limits if necessary.</li> </ul>
<ul style="list-style-type: none"> <li>• <b>CCO high / CCO low</b></li> </ul>	<ul style="list-style-type: none"> <li>• al. area</li> </ul>	Measurement values are equal to or outside the alarm limits.	<ul style="list-style-type: none"> <li>• Check the patient status.</li> <li>• Adjust alarm limits if necessary.</li> </ul>
<ul style="list-style-type: none"> <li>• <b>Check Ext Device</b></li> </ul>	<ul style="list-style-type: none"> <li>• param.</li> </ul>	Interfaced device should be checked.	<ul style="list-style-type: none"> <li>• Check the interfaced device.</li> <li>• If the problem persists, contact authorized service personnel.</li> </ul>
<ul style="list-style-type: none"> <li>• <b>C.O. Complete</b></li> </ul>	<ul style="list-style-type: none"> <li>• C.O. menu</li> </ul>	Successful cardiac output determination has been performed, but the module is not yet ready for a new measurement. Also when the 15 minute timeout for confirming the C.O. measurement expires with the <b>Cardiac Output &gt; Measurement</b> menu open.	<ul style="list-style-type: none"> <li>• Wait until the message disappears.</li> </ul>
<ul style="list-style-type: none"> <li>• <b>CO measurement removed</b></li> </ul>	<ul style="list-style-type: none"> <li>• al. area</li> </ul>	Acquisition module has been removed.	<ul style="list-style-type: none"> <li>• Connect the module if you want to restart the measurement.</li> </ul>
<ul style="list-style-type: none"> <li>• <b>C.O. out of range</b></li> </ul>	<ul style="list-style-type: none"> <li>• C.O. menu</li> </ul>	The measurement results are invalid.	<ul style="list-style-type: none"> <li>• Perform a new measurement.</li> </ul>
<ul style="list-style-type: none"> <li>• <b>Confirm C.O.</b></li> </ul>	<ul style="list-style-type: none"> <li>• al. area, param.</li> </ul>	Measurement data has not been confirmed before trying to exit the <b>Cardiac Output &gt; Measurement</b> menu.  If more than 15 minutes have passed since the start of the C.O. measurement, this message resets automatically.	<ul style="list-style-type: none"> <li>• Select <b>Confirm C.O.</b></li> </ul>
<ul style="list-style-type: none"> <li>• <b>Curve over range</b></li> </ul>	<ul style="list-style-type: none"> <li>• C.O. menu</li> </ul>	Thermodilution waveform values are over the valid range.	<ul style="list-style-type: none"> <li>• Wait for the blood temperature to stabilize and retry the measurement.</li> </ul>
<ul style="list-style-type: none"> <li>• <b>Curve under range</b></li> </ul>	<ul style="list-style-type: none"> <li>• C.O. menu</li> </ul>	Thermodilution waveform values are under the valid range.	<ul style="list-style-type: none"> <li>• Wait for the blood temperature to stabilize and retry the measurement.</li> </ul>
<ul style="list-style-type: none"> <li>• <b>Identical C.O. modules</b></li> </ul>	<ul style="list-style-type: none"> <li>• al. area</li> </ul>	There are two or more identical C.O. modules in the system.  Also when there are more than one active C.O. sources.	<ul style="list-style-type: none"> <li>• Remove all but one C.O. module.</li> </ul>

Message	Location	Explanation	What to do
<ul style="list-style-type: none"> <li>• <b>Inject now!</b></li> </ul>	<ul style="list-style-type: none"> <li>• C.O. menu</li> </ul>	A prompt text during the <b>Manual</b> C.O. measurement.	<ul style="list-style-type: none"> <li>• Inject the injectate solution smoothly within 4 to 5 seconds.</li> </ul>
<ul style="list-style-type: none"> <li>• <b>Inject When Ready</b></li> </ul>	<ul style="list-style-type: none"> <li>• C.O. menu</li> </ul>	A prompt text during the <b>Automatic</b> C.O. measurement.	<ul style="list-style-type: none"> <li>• Inject the injectate solution smoothly within 4 to 5 seconds.</li> </ul>
<ul style="list-style-type: none"> <li>• <b>Irregular curve</b></li> </ul>	<ul style="list-style-type: none"> <li>• C.O. menu</li> </ul>	Thermodilution waveform is irregular.	<ul style="list-style-type: none"> <li>• Perform a new measurement.</li> </ul>
<ul style="list-style-type: none"> <li>• <b>Irregular HR</b></li> </ul>	<ul style="list-style-type: none"> <li>• C.O. menu</li> </ul>	HR measurement values are irregular.	<ul style="list-style-type: none"> <li>• Check the patient status.</li> </ul>
<ul style="list-style-type: none"> <li>• <b>Measuring</b></li> </ul>	<ul style="list-style-type: none"> <li>• C.O. menu</li> </ul>	Determining the C.O. value.	<ul style="list-style-type: none"> <li>• Wait until the message disappears.</li> </ul>
<ul style="list-style-type: none"> <li>• <b>No catheter</b></li> </ul>	<ul style="list-style-type: none"> <li>• C.O. menu</li> </ul>	No catheter connected.	<ul style="list-style-type: none"> <li>• Connect a catheter.</li> </ul>
<ul style="list-style-type: none"> <li>• <b>No Comp Constant. Check C.O. setup</b></li> </ul>	<ul style="list-style-type: none"> <li>• C.O. menu</li> </ul>	The computation constant is not available for the selected catheter, injectate volume, and injectate probe combination.	<ul style="list-style-type: none"> <li>• Check the C.O. setup selections.</li> </ul>
<ul style="list-style-type: none"> <li>• <b>No ext device</b></li> </ul>	<ul style="list-style-type: none"> <li>• param.</li> </ul>	Interfaced device should be checked.	<ul style="list-style-type: none"> <li>• Check the interfaced device.</li> <li>• If the problem persists, contact authorized service personnel.</li> </ul>
<ul style="list-style-type: none"> <li>• <b>No injectate temp probe</b></li> </ul>	<ul style="list-style-type: none"> <li>• C.O. menu</li> </ul>	No injectate temperature probe connected.	<ul style="list-style-type: none"> <li>• Connect an injectate temperature probe.</li> </ul>
<ul style="list-style-type: none"> <li>• <b>No HR for REF</b></li> </ul>	<ul style="list-style-type: none"> <li>• C.O. menu</li> </ul>	REF measurement cannot be done.	<ul style="list-style-type: none"> <li>• Check that the patient's heart rate is being monitored.</li> <li>• Add HR measurement if needed.</li> </ul>
<ul style="list-style-type: none"> <li>• <b>No module</b></li> </ul>	<ul style="list-style-type: none"> <li>• C.O. menu</li> </ul>	No C.O. module connected.	<ul style="list-style-type: none"> <li>• Connect a C.O. module to measure cardiac output.</li> </ul>
<ul style="list-style-type: none"> <li>• <b>Noisy baseline</b></li> </ul>	<ul style="list-style-type: none"> <li>• C.O. menu</li> </ul>	Changes in patient's blood temperature affect C.O. measuring.	<ul style="list-style-type: none"> <li>• Check the patient status.</li> <li>• Check the blood temperature connector.</li> </ul>
<ul style="list-style-type: none"> <li>• <b>Please wait</b></li> </ul>	<ul style="list-style-type: none"> <li>• C.O. menu</li> </ul>	A failed, canceled, or stopped C.O. determination and the module not yet ready for the next measurement.	<ul style="list-style-type: none"> <li>• Wait until the message disappears.</li> </ul>
<ul style="list-style-type: none"> <li>• <b>Press Start C.O.</b></li> </ul>	<ul style="list-style-type: none"> <li>• C.O. menu</li> </ul>	Prompt text during the <b>Manual</b> measurement mode.	<ul style="list-style-type: none"> <li>• Proceed with the measurement by selecting <b>Start C.O.</b> With E-modules, you can also use the <b>Start C.O.</b> module key.</li> </ul>
<ul style="list-style-type: none"> <li>• <b>Press Start C.O. Serial</b></li> </ul>	<ul style="list-style-type: none"> <li>• C.O. menu</li> </ul>	Prompt text during the <b>Automatic</b> measurement mode.	<ul style="list-style-type: none"> <li>• Proceed with the measurement by selecting <b>Start C.O. Serial</b>.</li> </ul>

Message	Location	Explanation	What to do
<ul style="list-style-type: none"> <li>• <b>REF out of range</b></li> </ul>	<ul style="list-style-type: none"> <li>• C.O. menu</li> </ul>	The result of the REF measurement is invalid.	<ul style="list-style-type: none"> <li>• Check cables and connections.</li> <li>• Perform a new measurement.</li> <li>• If the problem persists, contact authorized service personnel.</li> </ul>
<ul style="list-style-type: none"> <li>• <b>Signal Adapting</b></li> </ul>	<ul style="list-style-type: none"> <li>• param.</li> </ul>	Interfaced device signal is being processed.	<ul style="list-style-type: none"> <li>• Wait until the message disappears.</li> </ul>
<ul style="list-style-type: none"> <li>• <b>Tblood over range</b></li> </ul>	<ul style="list-style-type: none"> <li>• C.O. menu</li> </ul>	Blood temperature is over the limit: 43°C with E-modules, 44°C with PDM, 42.2°C with TRAM.	<ul style="list-style-type: none"> <li>• Check the catheter position.</li> <li>• Check that there is no heat or cold source near the catheter.</li> <li>• The temperature sensor may be damaged; replace the catheter.</li> </ul>
<ul style="list-style-type: none"> <li>• <b>Tblood sensor failed</b></li> </ul>	<ul style="list-style-type: none"> <li>• al. area</li> </ul>	Blood temperature sensor failure.	<ul style="list-style-type: none"> <li>• Replace the catheter.</li> </ul>
<ul style="list-style-type: none"> <li>• <b>Tblood under range</b></li> </ul>	<ul style="list-style-type: none"> <li>• C.O. menu</li> </ul>	Blood temperature is under the limit: 17.5°C with E-modules, 28°C with PDM, 29.8°C with TRAM.	<ul style="list-style-type: none"> <li>• Check the catheter position.</li> <li>• Check that there is no heat or cold source near the catheter.</li> <li>• The temperature sensor may be damaged; replace the catheter.</li> </ul>
<ul style="list-style-type: none"> <li>• <b>Tinj high</b></li> </ul>	<ul style="list-style-type: none"> <li>• C.O. menu</li> </ul>	Injectate temperature is too close to blood temperature or too warm.	<ul style="list-style-type: none"> <li>• Use colder injectate.</li> </ul>
<ul style="list-style-type: none"> <li>• <b>Tinj low</b></li> </ul>	<ul style="list-style-type: none"> <li>• C.O. menu</li> </ul>	Injectate temperature is too close to blood temperature or too cold.	<ul style="list-style-type: none"> <li>• Use warmer injectate.</li> </ul>
<ul style="list-style-type: none"> <li>• <b>Tinj sensor failed</b></li> </ul>	<ul style="list-style-type: none"> <li>• C.O. menu</li> </ul>	Injectate temperature sensor failure.	<ul style="list-style-type: none"> <li>• Replace the sensor.</li> </ul>
<ul style="list-style-type: none"> <li>• <b>Unstable Tblood</b></li> </ul>	<ul style="list-style-type: none"> <li>• param., C.O. menu</li> </ul>	<ul style="list-style-type: none"> <li>• Measurement in auto mode detects the unstable baseline patient temperature.</li> </ul>	<ul style="list-style-type: none"> <li>• Check the patient status.</li> <li>• Change C.O. measurement to manual mode and repeat the measurement.</li> </ul>

## Messages related to SvO₂ measurement

For information regarding alarm priorities and escalation times, see the supplemental information manual.

Make sure you are familiar with the generic layout of the screen. This will help you identify where on screen the following messages appear. The message location is indicated with the following abbreviations:

- al. area = alarm area
- param. = parameter window
- report = report view
- wavef. = waveform area

Message	Location	Explanation	What to do
<ul style="list-style-type: none"> <li>• <b>Calibrating</b></li> </ul>	<ul style="list-style-type: none"> <li>• param.</li> </ul>	Calibration factors are being calculated and stored to the module.	<ul style="list-style-type: none"> <li>• No action required.</li> </ul>
<ul style="list-style-type: none"> <li>• <b>Check cath. position</b></li> </ul>	<ul style="list-style-type: none"> <li>• param.</li> </ul>	Low signal quality.	<ul style="list-style-type: none"> <li>• Check the connections and catheter.</li> </ul>
<ul style="list-style-type: none"> <li>• <b>Check Ext Device</b></li> </ul>	<ul style="list-style-type: none"> <li>• param.</li> </ul>	Interfaced device should be checked.	<ul style="list-style-type: none"> <li>• Check the interfaced device.</li> <li>• If the problem persists, contact authorized service personnel.</li> </ul>
<ul style="list-style-type: none"> <li>• <b>Connecting</b></li> </ul>	<ul style="list-style-type: none"> <li>• param.</li> </ul>	Connection to the interfaced device is being established.	<ul style="list-style-type: none"> <li>• No action required.</li> </ul>
<ul style="list-style-type: none"> <li>• <b>Damped Intensity</b></li> </ul>	<ul style="list-style-type: none"> <li>• param.</li> </ul>	There may be problems with connections.	<ul style="list-style-type: none"> <li>• Check the catheter.</li> <li>• Check the cable and connections.</li> <li>• Recalibrate in vivo.</li> <li>• If the problem persists, contact authorized service personnel.</li> </ul>
<ul style="list-style-type: none"> <li>• <b>Draw blood</b></li> </ul>	<ul style="list-style-type: none"> <li>• param.</li> </ul>	An advisory prompt.	<ul style="list-style-type: none"> <li>• Draw blood as indicated on screen.</li> </ul>
<ul style="list-style-type: none"> <li>• <b>Enter lab results</b></li> </ul>	<ul style="list-style-type: none"> <li>• param.</li> </ul>	Calibration sequence requires lab results.	<ul style="list-style-type: none"> <li>• Enter laboratory results as indicated on screen.</li> </ul>
<ul style="list-style-type: none"> <li>• <b>High Intensity</b></li> </ul>	<ul style="list-style-type: none"> <li>• param.</li> </ul>	Catheter floated or up against vessel wall.	<ul style="list-style-type: none"> <li>• Check the optical module and connections.</li> <li>• Check the catheter placement.</li> <li>• Only authorized medical personnel should adjust catheter placement.</li> </ul>
<ul style="list-style-type: none"> <li>• <b>In vitro calibrating</b></li> </ul>	<ul style="list-style-type: none"> <li>• param.</li> </ul>	In vitro calibration is in process.	<ul style="list-style-type: none"> <li>• Wait until the message disappears.</li> </ul>
<ul style="list-style-type: none"> <li>• <b>In vitro failed</b></li> </ul>	<ul style="list-style-type: none"> <li>• param.</li> </ul>	Unsuccessful calibration.	<ul style="list-style-type: none"> <li>• Check connections and catheter.</li> <li>• Change optical module and recalibrate.</li> <li>• If the problem persists, contact authorized service personnel.</li> </ul>
<ul style="list-style-type: none"> <li>• <b>In vivo calibrating</b></li> </ul>	<ul style="list-style-type: none"> <li>• param.</li> </ul>	In vivo calibration is in process.	<ul style="list-style-type: none"> <li>• Wait until the message disappears.</li> </ul>

Message	Location	Explanation	What to do
<ul style="list-style-type: none"> <li><b>In vivo poor signal</b></li> </ul>	<ul style="list-style-type: none"> <li>param.</li> </ul>	The measurement cannot be performed because the signal is too weak.	<ul style="list-style-type: none"> <li>Check connections and catheter.</li> <li>Change optical module and recalibrate.</li> <li>If the problem persists, the catheter could be faulty; replace the catheter.</li> </ul>
<ul style="list-style-type: none"> <li><b>Insufficient signal</b></li> </ul>	<ul style="list-style-type: none"> <li>param.</li> </ul>	The measurement cannot be performed because the signal is too weak.	<ul style="list-style-type: none"> <li>Check the patient status.</li> <li>Check connections and catheter.</li> <li>If the problem persists, contact authorized service personnel.</li> </ul>
<ul style="list-style-type: none"> <li><b>Intensity shift</b></li> </ul>	<ul style="list-style-type: none"> <li>param.</li> </ul>	The measurement cannot be performed because the signal intensity changed.	<ul style="list-style-type: none"> <li>Check the patient status.</li> <li>Check connections and catheter.</li> <li>If the problem persists, contact authorized service personnel.</li> </ul>
<ul style="list-style-type: none"> <li><b>Low Intensity</b></li> </ul>	<ul style="list-style-type: none"> <li>param.</li> </ul>	Catheter floated or up against vessel wall.	<ul style="list-style-type: none"> <li>Check the optical module and connections.</li> <li>Check the catheter placement.</li> <li>Only authorized medical personnel should adjust catheter placement.</li> </ul>
<ul style="list-style-type: none"> <li><b>Low Light</b></li> </ul>	<ul style="list-style-type: none"> <li>param.</li> </ul>	Catheter floated or up against vessel wall.	<ul style="list-style-type: none"> <li>Check the optical module and connections.</li> <li>Check the catheter placement.</li> <li>Repeat in vivo calibration.</li> </ul>
<ul style="list-style-type: none"> <li><b>No Light</b></li> </ul>	<ul style="list-style-type: none"> <li>param.</li> </ul>	Interfaced device should be checked.	<ul style="list-style-type: none"> <li>Check the interfaced device.</li> <li>If the problem persists, contact authorized service personnel.</li> </ul>
<ul style="list-style-type: none"> <li><b>Re-calibrate SvO2</b></li> </ul>	<ul style="list-style-type: none"> <li>al. area, param.</li> </ul>	The calibration is over 24 hours old.	<ul style="list-style-type: none"> <li>Perform in vivo calibration.</li> </ul>
<ul style="list-style-type: none"> <li><b>Start SvO2</b></li> </ul>	<ul style="list-style-type: none"> <li>param.</li> </ul>	Displays when the catheter has been inserted into the patient after in-vitro calibration.	<ul style="list-style-type: none"> <li>Select the <b>Start SvO2</b> option from the SvO₂ menu.</li> </ul>
<ul style="list-style-type: none"> <li><b>SvO2 cable off</b></li> </ul>	<ul style="list-style-type: none"> <li>al. area</li> </ul>	The cable is disconnected from the module.	<ul style="list-style-type: none"> <li>Re-connect the cable to the module.</li> </ul>
<ul style="list-style-type: none"> <li><b>SvO2 faulty cable</b></li> </ul>	<ul style="list-style-type: none"> <li>al. area, param.</li> </ul>	The optical module has failed.	<ul style="list-style-type: none"> <li>Check the optical module and connections.</li> <li>Replace the optical module.</li> </ul>

Message	Location	Explanation	What to do
<ul style="list-style-type: none"> <li>• <b><i>SvO2 high / SvO2 low</i></b></li> </ul>	<ul style="list-style-type: none"> <li>• al. area</li> </ul>	Measurement values are equal to or outside the alarm limits.	<ul style="list-style-type: none"> <li>• Check the patient status.</li> <li>• Adjust alarm limits if necessary.</li> </ul>
<ul style="list-style-type: none"> <li>• <b><i>SvO2 measurement removed</i></b></li> </ul>	<ul style="list-style-type: none"> <li>• al. area</li> </ul>	Acquisition module has been removed.	<ul style="list-style-type: none"> <li>• Connect the module if you want to restart the measurement.</li> </ul>
<ul style="list-style-type: none"> <li>• <b><i>SvO2 not calibrated</i></b></li> </ul>	<ul style="list-style-type: none"> <li>• al. area, param.</li> </ul>	The optical module is connected to the monitor and the catheter has not been calibrated.	<ul style="list-style-type: none"> <li>• Perform in vivo calibration.</li> </ul>
<ul style="list-style-type: none"> <li>• <b><i>SvO2 out of range</i></b></li> </ul>	<ul style="list-style-type: none"> <li>• param.</li> </ul>	Values are above or below the range the monitor can process.	<ul style="list-style-type: none"> <li>• Check cables and connections.</li> <li>• Repeat in vivo calibration.</li> <li>• Change the optical module.</li> <li>• If the catheter is faulty, replace it.</li> <li>• If the cable or module is broken, contact authorized service personnel.</li> </ul>
<ul style="list-style-type: none"> <li>• <b><i>SvO2 signal poor</i></b></li> </ul>	<ul style="list-style-type: none"> <li>• al. area, param.</li> </ul>	There is signal pulsation, the catheter is touching the wall, or there is an intensity shift in signal quality level.	<ul style="list-style-type: none"> <li>• Flush the catheter.</li> <li>• Check the optical module and connections.</li> <li>• Check the catheter placement.</li> </ul>
<ul style="list-style-type: none"> <li>• <b><i>SvO2 temp error</i></b></li> </ul>	<ul style="list-style-type: none"> <li>• al. area</li> </ul>	The temperature of the optical module is out of range for more than 10 minutes.	<ul style="list-style-type: none"> <li>• Check the optical module and connections.</li> <li>• Replace the optical module.</li> <li>• Contact authorized service personnel.</li> </ul>
<ul style="list-style-type: none"> <li>• <b><i>Wait, initializing</i></b></li> </ul>	<ul style="list-style-type: none"> <li>• param.</li> </ul>	Optical module signal is being processed.	<ul style="list-style-type: none"> <li>• Wait until the message disappears.</li> </ul>
<ul style="list-style-type: none"> <li>• <b><i>Warming up</i></b></li> </ul>	<ul style="list-style-type: none"> <li>• param.</li> </ul>	The optical module is warming up.	<ul style="list-style-type: none"> <li>• Wait until the module has warmed up and the message disappears.</li> </ul>

## Messages related to gases measurement

For information regarding alarm priorities and escalation times, see the supplemental information manual.

Make sure you are familiar with the generic layout of the screen. This will help you identify where on screen the following messages appear. The message location is indicated with the following abbreviations:

- al. area = alarm area
- param. = parameter window
- report = report view
- wavef. = waveform area



Message	Location	Explanation	What to do
<ul style="list-style-type: none"> <li>• <b>Agent mixture</b></li> </ul>	<ul style="list-style-type: none"> <li>• al. area, param.</li> </ul>	Mixture of halogenated agents is detected.	<ul style="list-style-type: none"> <li>• Check the ventilator and agent vaporizer settings.</li> </ul>
<ul style="list-style-type: none"> <li>• <b>Apnea (CO2)</b></li> </ul>	<ul style="list-style-type: none"> <li>• al. area, wavef.</li> </ul>	No breathing detected.	<ul style="list-style-type: none"> <li>• Check the patient status.</li> <li>• Check the ventilator and breathing status.</li> </ul>
<ul style="list-style-type: none"> <li>• <b>Apnea deactivated</b></li> </ul>	<ul style="list-style-type: none"> <li>• param.</li> </ul>	A new case has just been started/a new patient admitted, or the measurement has just been started and the apnea alarm is not active yet.	<ul style="list-style-type: none"> <li>• Wait. The message disappears after the monitor detects 3 breaths during the last minute (E-modules), or the respiration rate is $\geq 3$ per minute (CAPNOSTAT, Dual CO2, CapnoFlex).</li> </ul>
<ul style="list-style-type: none"> <li>• <b>Calibrate sensor</b></li> </ul>	<ul style="list-style-type: none"> <li>• param.</li> </ul>	A new sensor is introduced or there is a signal drift in the electronics.	<ul style="list-style-type: none"> <li>• Perform sensor calibration.</li> </ul>
<ul style="list-style-type: none"> <li>• <b>Calibrate system</b></li> </ul>	<ul style="list-style-type: none"> <li>• param.</li> </ul>	Interfaced device should be calibrated.	<ul style="list-style-type: none"> <li>• Check the interfaced device.</li> <li>• If the problem persists, contact authorized service personnel.</li> </ul>
<ul style="list-style-type: none"> <li>• <b>Calibrating</b></li> </ul>	<ul style="list-style-type: none"> <li>• param.</li> </ul>	Calibration is in progress.	<ul style="list-style-type: none"> <li>• No action required.</li> </ul>
<ul style="list-style-type: none"> <li>• <b>Calibrating gas sensor</b></li> </ul>	<ul style="list-style-type: none"> <li>• wavef.</li> </ul>	The measurement has been started and calibration is in progress.	<ul style="list-style-type: none"> <li>• Wait until the calibration is completed and the message disappears.</li> </ul>
<ul style="list-style-type: none"> <li>• <b>Calibration error</b></li> </ul>	<ul style="list-style-type: none"> <li>• param.</li> </ul>	Unsuccessful calibration.	<ul style="list-style-type: none"> <li>• Authorized service personnel should repeat the calibration procedure.</li> </ul>
<ul style="list-style-type: none"> <li>• <b>Check/calibr. adapter</b></li> </ul>	<ul style="list-style-type: none"> <li>• al. area, param.</li> </ul>	The adapter is missing, obstructed, or of a different type than in the last calibration.	<ul style="list-style-type: none"> <li>• Check that there is an adapter in the system.</li> <li>• Check the adapter for blockages.</li> <li>• Calibrate the adapter.</li> </ul>
<ul style="list-style-type: none"> <li>• <b>Check ext device</b></li> </ul>	<ul style="list-style-type: none"> <li>• param.</li> </ul>	Interfaced device should be checked.	<ul style="list-style-type: none"> <li>• Check the interfaced device.</li> <li>• If the problem persists, contact authorized service personnel.</li> </ul>
<ul style="list-style-type: none"> <li>• <b>Check sample gas out</b></li> </ul>	<ul style="list-style-type: none"> <li>• al. area</li> </ul>	The water trap is not connected, the sample gas outflow is blocked, or there is a leak inside the module.	<ul style="list-style-type: none"> <li>• Check water trap connection.</li> <li>• Remove the blockage from the sample gas outlet.</li> <li>• Change module if needed.</li> </ul>
<ul style="list-style-type: none"> <li>• <b>Check sample line</b></li> </ul>	<ul style="list-style-type: none"> <li>• al. area, param.</li> </ul>	The sample line is disconnected, or of a different type than the last one used.	<ul style="list-style-type: none"> <li>• Reconnect the disconnected sample line.</li> <li>• Calibrate the sample line.</li> </ul>

Message	Location	Explanation	What to do
<ul style="list-style-type: none"> <li>• <b>Check water trap and sample gas out. Press Normal Screen to continue.</b></li> </ul>	<ul style="list-style-type: none"> <li>• wavef.</li> </ul>	The water trap is not connected, the sample gas outflow is blocked, or there is a leak inside the module.	<ul style="list-style-type: none"> <li>• Check water trap connection.</li> <li>• Remove the blockage from the sample gas outlet.</li> <li>• Change module if needed.</li> </ul>
<ul style="list-style-type: none"> <li>• <b>Check Water Trap</b></li> </ul>	<ul style="list-style-type: none"> <li>• al. area, param.</li> </ul>	Water trap connection is not correct, or there is a leak in the sampling line inside the module.	<ul style="list-style-type: none"> <li>• Check the patient status.</li> <li>• Check the water trap and its connection.</li> </ul>
<ul style="list-style-type: none"> <li>• <b>Continuous blockage, check sample line. Restart pump.</b></li> </ul>	<ul style="list-style-type: none"> <li>• wavef.</li> </ul>	Nasal cannula, moisture filter, sidestream adapter tube, or exhaust line is blocked.	<ul style="list-style-type: none"> <li>• Check all parts of the equipment to patient connection and remove any blockages.</li> <li>• If necessary, change the line.</li> </ul>
<ul style="list-style-type: none"> <li>• <b>Continuous blockage. Check sample line and water trap.</b></li> </ul>	<ul style="list-style-type: none"> <li>• wavef.</li> </ul>	The gas sampling line is blocked or the water trap is occluded.	<ul style="list-style-type: none"> <li>• Change sampling line and water trap.</li> </ul>
<ul style="list-style-type: none"> <li>• <b>EtAA high</b></li> <li>• <b>EtAA low</b></li> </ul> <p>where AA = Hal, Enf, Iso, Sev or Des</p>	<ul style="list-style-type: none"> <li>• al. area</li> </ul>	Measurement values are equal to or outside the alarm limits.	<ul style="list-style-type: none"> <li>• Check the patient status.</li> <li>• Adjust alarm limits if necessary.</li> </ul>
<ul style="list-style-type: none"> <li>• <b>EtCO2 high</b></li> <li>• <b>EtCO2 low</b></li> <li>• <b>EtN2O high</b></li> <li>• <b>EtN2O low</b></li> <li>• <b>EtO2 high</b></li> <li>• <b>EtO2 low</b></li> </ul>	<ul style="list-style-type: none"> <li>• al. area</li> </ul>	Measurement values are equal to or outside the alarm limits.	<ul style="list-style-type: none"> <li>• Check the patient status.</li> <li>• Adjust alarm limits if necessary.</li> </ul>
<ul style="list-style-type: none"> <li>• <b>Ext:Apnea</b></li> </ul>	<ul style="list-style-type: none"> <li>• al. area</li> </ul>	No breathing detected.	<ul style="list-style-type: none"> <li>• Check the patient status.</li> <li>• Check the ventilator and the breathing status.</li> <li>• Check the interfaced device.</li> </ul>
<ul style="list-style-type: none"> <li>• <b>Ext not supported</b></li> </ul>	<ul style="list-style-type: none"> <li>• param.</li> </ul>	Interfaced device is not supported.	<ul style="list-style-type: none"> <li>• See the Unity Network Interface Device (ID) Operator's Manual for supported devices.</li> <li>• If the problem persists, contact authorized service personnel.</li> </ul>
<ul style="list-style-type: none"> <li>• <b>Failure in Agent ID</b></li> </ul>	<ul style="list-style-type: none"> <li>• param.</li> </ul>	An unknown agent or three or more agents detected. Vaporizer may contain a mixture of agents.	<ul style="list-style-type: none"> <li>• Flush the breathing circuit with O₂ flush (O₂ +, 100% O₂).</li> <li>• Empty the vaporizer and refill from an unopened container.</li> </ul>

Message	Location	Explanation	What to do
<ul style="list-style-type: none"> <li>• <b>FiAA high</b></li> <li>• <b>FiAA low</b></li> </ul> where AA = Hal, Enf, Iso, Sev or Des	<ul style="list-style-type: none"> <li>• al. area</li> </ul>	Measurement values are equal to or outside the alarm limits.	<ul style="list-style-type: none"> <li>• Check the patient status.</li> <li>• Adjust alarm limits if necessary.</li> </ul>
<ul style="list-style-type: none"> <li>• <b>FiCO2 high</b></li> <li>• <b>FiCO2 low</b></li> <li>• <b>FiN2O high</b></li> <li>• <b>FiN2O low</b></li> <li>• <b>FiO2 high</b></li> <li>• <b>FiO2 low</b></li> </ul>	<ul style="list-style-type: none"> <li>• al. area</li> </ul>	Measurement values are equal to or outside the alarm limits.	<ul style="list-style-type: none"> <li>• Check the patient status.</li> <li>• Adjust alarm limits if necessary.</li> </ul>
<ul style="list-style-type: none"> <li>• <b>Gas measurements removed</b></li> </ul>	<ul style="list-style-type: none"> <li>• al. area</li> </ul>	Acquisition module has been removed.	<ul style="list-style-type: none"> <li>• Connect the module if you want to restart the measurement.</li> </ul>
<ul style="list-style-type: none"> <li>• <b>Gas module standby</b></li> </ul>	<ul style="list-style-type: none"> <li>• al. area</li> </ul>	Acquisition module has shut down the pump.	<ul style="list-style-type: none"> <li>• No action required.</li> </ul>
<ul style="list-style-type: none"> <li>• <b>Gas module standby. Touch any button/key to activate.</b></li> </ul>	<ul style="list-style-type: none"> <li>• wavef.</li> </ul>	Acquisition module has shut down the pump.	<ul style="list-style-type: none"> <li>• To exit the standby mode, touch any button or key.</li> <li>• No action required.</li> </ul>
<ul style="list-style-type: none"> <li>• <b>Identical gas modules</b></li> </ul>	<ul style="list-style-type: none"> <li>• al. area</li> </ul>	There are two or more E-modules with gas measurement in the system.	<ul style="list-style-type: none"> <li>• Remove all but one E-module with gas measurement.</li> </ul>
<ul style="list-style-type: none"> <li>• <b>Incompatible gas module</b></li> </ul>	<ul style="list-style-type: none"> <li>• al. area</li> </ul>	The module is not compatible.	<ul style="list-style-type: none"> <li>• Replace with compatible gas module. See the supplemental information manual.</li> <li>• If the problem persists, contact authorized service personnel.</li> </ul>
<ul style="list-style-type: none"> <li>• <b>Incompatible sensor</b></li> </ul>	<ul style="list-style-type: none"> <li>• param.</li> </ul>	The sensor is of wrong type.	<ul style="list-style-type: none"> <li>• Check and change the sensor to a correct type. See the supplemental information manual.</li> </ul>
<ul style="list-style-type: none"> <li>• <b>Interface Failed</b></li> </ul>	<ul style="list-style-type: none"> <li>• param.</li> </ul>	Interfaced device and Unity Network Interface Device (ID) should be checked.	<ul style="list-style-type: none"> <li>• Check the interfaced device.</li> <li>• If the problem persists, contact authorized service personnel.</li> </ul>
<ul style="list-style-type: none"> <li>• <b>Low gas sample flow</b></li> </ul>	<ul style="list-style-type: none"> <li>• al. area</li> </ul>	Sample flow is less than 80% of the module's nominal flow value. This can happen if nebulized medications are given without disconnecting the sample line.	<ul style="list-style-type: none"> <li>• Check the sample line.</li> <li>• If the problem persists, contact authorized service personnel.</li> </ul>
<ul style="list-style-type: none"> <li>• <b>No ext device</b></li> </ul>	<ul style="list-style-type: none"> <li>• param.</li> </ul>	Interfaced device should be checked.	<ul style="list-style-type: none"> <li>• Check the interfaced device.</li> <li>• If the problem persists, contact authorized service personnel.</li> </ul>

Message	Location	Explanation	What to do
<ul style="list-style-type: none"> <li>• <b>Over range</b></li> </ul>	<ul style="list-style-type: none"> <li>• param.</li> </ul>	Measured FiO ₂ is more than 103%.	<ul style="list-style-type: none"> <li>• Calibrate airway gases.</li> </ul>
<ul style="list-style-type: none"> <li>• <b>Over scale</b></li> </ul>	<ul style="list-style-type: none"> <li>• wavef.</li> </ul>	Gas signal exceeds the maximum waveform area.	<ul style="list-style-type: none"> <li>• Check the patient status.</li> <li>• Select a larger scale for waveform.</li> </ul>
<ul style="list-style-type: none"> <li>• <b>Purging</b></li> </ul>	<ul style="list-style-type: none"> <li>• param.</li> </ul>	Interfaced device should be checked.	<ul style="list-style-type: none"> <li>• Check the interfaced device.</li> <li>• If the problem persists, contact authorized service personnel.</li> </ul>
<ul style="list-style-type: none"> <li>• <b>Replace Water Trap</b></li> </ul>	<ul style="list-style-type: none"> <li>• al. area, param.</li> </ul>	Water trap is partially blocked.	<ul style="list-style-type: none"> <li>• Replace the water trap.</li> </ul>
<ul style="list-style-type: none"> <li>• <b>RR (CO2) High / RR (CO2) Low</b></li> </ul>	<ul style="list-style-type: none"> <li>• al. area</li> </ul>	Measurement values are equal to or outside the alarm limits.	<ul style="list-style-type: none"> <li>• Check the patient status.</li> <li>• Adjust alarm limits if necessary.</li> </ul>
<ul style="list-style-type: none"> <li>• <b>Sample line blocked</b></li> </ul>	<ul style="list-style-type: none"> <li>• al. area</li> </ul>	The gas sampling line is blocked or the water trap is occluded.	<ul style="list-style-type: none"> <li>• Change sampling line and water trap.</li> </ul>
<ul style="list-style-type: none"> <li>• <b>Sample gas out</b></li> </ul>	<ul style="list-style-type: none"> <li>• param.</li> </ul>	The water trap is not connected, the sample gas outflow is blocked, or there is a leak inside the module.	<ul style="list-style-type: none"> <li>• Check water trap connection.</li> <li>• Remove the blockage from the sample gas outlet.</li> <li>• Change module if needed.</li> </ul>
<ul style="list-style-type: none"> <li>• <b>Service CO2 module</b></li> </ul>	<ul style="list-style-type: none"> <li>• param.</li> </ul>	Technical failure in the module.	<ul style="list-style-type: none"> <li>• Contact authorized service personnel.</li> </ul>
<ul style="list-style-type: none"> <li>• <b>Service gas module</b></li> <li>• <b>Service gas module</b> - and specific error indication</li> </ul>	<ul style="list-style-type: none"> <li>• al.area, param., wavef.</li> </ul>	The measuring sensor is inoperative or the temperature in the module has increased.	<ul style="list-style-type: none"> <li>• Contact authorized service personnel.</li> </ul>
<ul style="list-style-type: none"> <li>• <b>Service ext device</b></li> </ul>	<ul style="list-style-type: none"> <li>• param.</li> </ul>	Interfaced device should be checked.	<ul style="list-style-type: none"> <li>• Contact authorized service personnel.</li> </ul>
<ul style="list-style-type: none"> <li>• <b>Service Mode</b></li> </ul>	<ul style="list-style-type: none"> <li>• param.</li> </ul>	Interfaced device should be checked.	<ul style="list-style-type: none"> <li>• Contact authorized service personnel.</li> </ul>
<ul style="list-style-type: none"> <li>• <b>Standby</b></li> </ul>	<ul style="list-style-type: none"> <li>• param.</li> </ul>	Acquisition module has shut down the pump.	<ul style="list-style-type: none"> <li>• No action required.</li> </ul>
<ul style="list-style-type: none"> <li>• <b>Warming up</b></li> </ul>	<ul style="list-style-type: none"> <li>• param.</li> </ul>	The sensor is warming up.	<ul style="list-style-type: none"> <li>• Wait until the message disappears.</li> </ul>
<ul style="list-style-type: none"> <li>• <b>Zero error</b></li> </ul>	<ul style="list-style-type: none"> <li>• param.</li> </ul>	Zeroing has failed.	<ul style="list-style-type: none"> <li>• Repeat the zeroing.</li> </ul>
<ul style="list-style-type: none"> <li>• <b>Zeroing</b></li> </ul>	<ul style="list-style-type: none"> <li>• param.</li> </ul>	Zeroing is in progress.	<ul style="list-style-type: none"> <li>• Wait until the zeroing is completed.</li> </ul>

## Messages related to spirometry measurement

For information regarding alarm priorities and escalation times, see the supplemental information manual.

Make sure you are familiar with the generic layout of the screen. This will help you identify where on screen the following messages appear. The message location is indicated with the following abbreviations:

- al. area = alarm area
- param. = parameter window
- report = report view
- wavef. = waveform area

Message	Location	Explanation	What to do
<ul style="list-style-type: none"> <li>• <b>Connecting</b></li> </ul>	<ul style="list-style-type: none"> <li>• param.</li> </ul>	Connection to the interfaced device is being established.	<ul style="list-style-type: none"> <li>• No action required.</li> </ul>
<ul style="list-style-type: none"> <li>• <b>Ext not supported</b></li> </ul>	<ul style="list-style-type: none"> <li>• param.</li> </ul>	Interfaced device is not supported.	<ul style="list-style-type: none"> <li>• See the Unity Network Interface Device (ID) Operator's Manual for supported devices.</li> <li>• If the problem persists, contact authorized service personnel.</li> </ul>
<ul style="list-style-type: none"> <li>• <b>Low volumes</b></li> </ul>	<ul style="list-style-type: none"> <li>• param.</li> </ul>	The water trap may not be properly connected, or there may be a leak in the breathing circuit. Tidal volumes detected are so small that inspiration and expiration cannot be distinguished from each other.	<ul style="list-style-type: none"> <li>• Check the patient status.</li> <li>• Check the water trap and its connection.</li> <li>• Check the breathing circuit for leaks.</li> <li>• Check the loops on screen to locate the problem.</li> </ul>
<ul style="list-style-type: none"> <li>• <b>MVexp &lt;&lt; MVinsp</b></li> </ul>	<ul style="list-style-type: none"> <li>• param.</li> </ul>	Exhaled volume is markedly smaller than inhaled.	<ul style="list-style-type: none"> <li>• Check the patient status.</li> <li>• Check the ventilatory system for leaks.</li> <li>• If the problem persists, contact authorized service personnel.</li> </ul>
<ul style="list-style-type: none"> <li>• <b>MVexp high / MVexp low</b></li> </ul>	<ul style="list-style-type: none"> <li>• al. area</li> </ul>	Measurement values are equal to or outside the alarm limits.	<ul style="list-style-type: none"> <li>• Check the patient status.</li> <li>• Adjust alarm limits if necessary.</li> </ul>
<ul style="list-style-type: none"> <li>• <b>No ext device</b></li> </ul>	<ul style="list-style-type: none"> <li>• param.</li> </ul>	Interfaced device should be checked.	<ul style="list-style-type: none"> <li>• Check the interfaced device.</li> <li>• If the problem persists, contact authorized service personnel.</li> </ul>
<ul style="list-style-type: none"> <li>• <b>Over scale</b></li> </ul>	<ul style="list-style-type: none"> <li>• wavef.</li> </ul>	Gas signal exceeds the maximum waveform area.	<ul style="list-style-type: none"> <li>• Check the patient status.</li> <li>• Select a larger scale for waveform.</li> </ul>

Messages

Message	Location	Explanation	What to do
<ul style="list-style-type: none"> <li>• <b>PEEP low</b></li> <li>• <b>PEEPe high / PEEPe low</b></li> <li>• <b>PEEPi high / PEEPi low</b></li> <li>• <b>PEEPtot high / PEEPtot low</b></li> </ul>	<ul style="list-style-type: none"> <li>• al. area</li> </ul>	Measurement values are equal to or outside the alarm limits.	<ul style="list-style-type: none"> <li>• Check the patient status.</li> <li>• Adjust alarm limits if necessary.</li> </ul>
<ul style="list-style-type: none"> <li>• <b>Ppeak high / Ppeak low</b></li> </ul>	<ul style="list-style-type: none"> <li>• al. area</li> </ul>	Measurement values are equal to or outside the alarm limits.	<ul style="list-style-type: none"> <li>• Check the patient status.</li> <li>• Adjust alarm limits if necessary.</li> </ul>
<ul style="list-style-type: none"> <li>• <b>Saving Loop</b></li> </ul>	<ul style="list-style-type: none"> <li>• al. area</li> </ul>	A loop is being saved.	<ul style="list-style-type: none"> <li>• Wait until the message disappears.</li> </ul>
<ul style="list-style-type: none"> <li>• <b>Scale changed</b></li> </ul>	<ul style="list-style-type: none"> <li>• wavef.</li> </ul>	The <b>Auto</b> scaling mode has changed the <b>Flow, Paw</b> or <b>Vol</b> scale.	<ul style="list-style-type: none"> <li>• Wait until the message disappears.</li> </ul>
<ul style="list-style-type: none"> <li>• <b>Service gas module</b></li> <li>• <b>Service gas module</b> - and specific error indication</li> </ul>	<ul style="list-style-type: none"> <li>• al.area, param., wavef.</li> </ul>	The measuring sensor is inoperative or the temperature in the module has increased.	<ul style="list-style-type: none"> <li>• Contact authorized service personnel.</li> </ul>
<ul style="list-style-type: none"> <li>• <b>TVexp low</b></li> </ul>	<ul style="list-style-type: none"> <li>• al. area</li> </ul>	Measured value is outside or equal to the alarm limit.	<ul style="list-style-type: none"> <li>• Check the patient status.</li> <li>• Adjust alarm limits if necessary.</li> </ul>
<ul style="list-style-type: none"> <li>• <b>Vent: Apnea</b></li> </ul>	<ul style="list-style-type: none"> <li>• al. area</li> </ul>	No breathing detected.	<ul style="list-style-type: none"> <li>• Check the patient status.</li> <li>• Check the interfaced device.</li> </ul>
<ul style="list-style-type: none"> <li>• <b>Vent: Check ventilator</b></li> </ul>	<ul style="list-style-type: none"> <li>• al. area</li> </ul>	The interfaced device needs to be checked.	<ul style="list-style-type: none"> <li>• Check the interfaced device.</li> <li>• If the problem persists, contact authorized service personnel.</li> </ul>
<ul style="list-style-type: none"> <li>• <b>Vent: Connecting</b></li> </ul>	<ul style="list-style-type: none"> <li>• al. area</li> </ul>	Interfaced device is being connected to the monitor through Unity Network Interface Device (ID).	<ul style="list-style-type: none"> <li>• No action required.</li> </ul>
<ul style="list-style-type: none"> <li>• <b>Vent: Disconnect</b></li> </ul>	<ul style="list-style-type: none"> <li>• al. area</li> </ul>	Interfaced device needs to be checked.	<ul style="list-style-type: none"> <li>• Check the patient status.</li> <li>• Check the ventilator tubing and patient connection.</li> <li>• Check the interfaced device.</li> <li>• If the problem persists, contact authorized service personnel.</li> </ul>

Message	Location	Explanation	What to do
<ul style="list-style-type: none"> <li>• <b>Vent: Ext not supported</b></li> </ul>	<ul style="list-style-type: none"> <li>• al. area</li> </ul>	Interfaced device is not supported.	<ul style="list-style-type: none"> <li>• See the Unity Network Interface Device (ID) Operator's Manual for supported devices.</li> <li>• If the problem persists, contact authorized service personnel.</li> </ul>
<ul style="list-style-type: none"> <li>• <b>Vent: In Alarm</b></li> </ul>	<ul style="list-style-type: none"> <li>• al. area</li> </ul>	Interfaced device needs to be checked.	<ul style="list-style-type: none"> <li>• Check the patient status.</li> <li>• Check the ventilator tubing and patient connection.</li> <li>• Check the interfaced device.</li> </ul>
<ul style="list-style-type: none"> <li>• <b>Vent: Low battery</b></li> </ul>	<ul style="list-style-type: none"> <li>• al. area</li> </ul>	Interfaced device needs to be checked.	<ul style="list-style-type: none"> <li>• Check the interfaced device.</li> <li>• If the problem persists, contact authorized service personnel.</li> </ul>
<ul style="list-style-type: none"> <li>• <b>Vent: No ext device</b></li> </ul>	<ul style="list-style-type: none"> <li>• al. area</li> </ul>	Interfaced device is not detected by Unity Network Interface Device (ID).	<ul style="list-style-type: none"> <li>• Check the interfaced device.</li> <li>• If the problem persists, contact authorized service personnel.</li> </ul>
<ul style="list-style-type: none"> <li>• <b>Ventilator interface removed</b></li> </ul>	al. area	The cable between the Unity Network Interface Device (ID) and the interfaced device has been removed.	<ul style="list-style-type: none"> <li>• Reconnect the cable if you want to restart the interface.</li> </ul>
<ul style="list-style-type: none"> <li>• <b>Zeroing error</b></li> </ul>	<ul style="list-style-type: none"> <li>• param.</li> </ul>	Zeroing has failed.	<ul style="list-style-type: none"> <li>• Repeat the zeroing.</li> </ul>
<ul style="list-style-type: none"> <li>• <b>Zeroing</b></li> </ul>	<ul style="list-style-type: none"> <li>• param.</li> </ul>	Zeroing is in progress.	<ul style="list-style-type: none"> <li>• Wait until the zeroing is completed.</li> </ul>

## Messages related to gas exchange measurement

For information regarding alarm priorities and escalation times, see the supplemental information manual.

Make sure you are familiar with the generic layout of the screen. This will help you identify where on screen the following messages appear. The message location is indicated with the following abbreviations:

- al. area = alarm area
- param. = parameter window
- report = report view
- wavef. = waveform area

Message	Location	Explanation	What to do
<ul style="list-style-type: none"> <li>• <b>Artifact</b></li> </ul>	<ul style="list-style-type: none"> <li>• param.</li> </ul>	The sample line length is not correct.	<ul style="list-style-type: none"> <li>• Check that the sample line length is 2 meters.</li> <li>• Change sample line if necessary.</li> </ul>
<ul style="list-style-type: none"> <li>• <b>Bypass flow high</b></li> </ul>	<ul style="list-style-type: none"> <li>• param.</li> </ul>	The module is unable to synchronize flow and CO ₂ due to bypass flow.	<ul style="list-style-type: none"> <li>• Add a 5 ml spacer to the patient circuit between the Y-piece and D-lite.</li> <li>• Shorten the expiration time to avoid expiratory flow pause.</li> </ul>
<ul style="list-style-type: none"> <li>• <b>No VO₂, FiN₂O high</b></li> </ul>	<ul style="list-style-type: none"> <li>• param.</li> </ul>	Module has detected N ₂ O.	<ul style="list-style-type: none"> <li>• Gas exchange cannot be measured if N₂O is used. If you wish to measure gas exchange, use another anesthetic. If the measurement is not used, you may consider removing gas exchange numbers from the screen.</li> </ul>
<ul style="list-style-type: none"> <li>• <b>No VO₂, FiO₂ &gt;85%</b></li> </ul>	<ul style="list-style-type: none"> <li>• param.</li> </ul>	Measured FiO ₂ is more than 85%.	<ul style="list-style-type: none"> <li>• Gas exchange cannot be measured if FiO₂ is more than 85%. If the patient's oxygen values are consistently high, you may consider removing gas exchange numbers from the screen.</li> </ul>
<ul style="list-style-type: none"> <li>• <b>Out of range</b></li> </ul>	<ul style="list-style-type: none"> <li>• param.</li> </ul>	VO ₂ or VCO ₂ is below 0 ml/min or above 999 ml/min.	<ul style="list-style-type: none"> <li>• Check that the gas sampling line and spirometry lines are correctly connected to the patient airway and to the gas module.</li> <li>• Check that the correct sensor type (D-lite/Pedi Lite) has been selected from the monitor menu.</li> </ul>
<ul style="list-style-type: none"> <li>• <b>Service gas module</b></li> <li>• <b>Service gas module</b> - and specific error indication</li> </ul>	<ul style="list-style-type: none"> <li>• al.area, param., wavef.</li> </ul>	The measuring sensor is inoperative or the temperature in the module has increased.	<ul style="list-style-type: none"> <li>• Contact authorized service personnel.</li> </ul>

## Messages related to Entropy measurement

For information regarding alarm priorities and escalation times, see the supplemental information manual.

Make sure you are familiar with the generic layout of the screen. This will help you identify where on screen the following messages appear. The message location is indicated with the following abbreviations:

- al. area = alarm area
- param. = parameter window



- report = report view
- wavef. = waveform area

Message	Location	Explanation	What to do
<ul style="list-style-type: none"> <li>• <b>Artifacts</b></li> </ul>	<ul style="list-style-type: none"> <li>• param., wavef.</li> </ul>	Signals contain noise or artifact.	<ul style="list-style-type: none"> <li>• Check sensor contact.</li> <li>• Remove sources of excessive noise.</li> </ul>
<ul style="list-style-type: none"> <li>• <b>Automatic check off</b></li> </ul>	<ul style="list-style-type: none"> <li>• param.</li> </ul>	Automatic sensor check has been turned off.	<ul style="list-style-type: none"> <li>• If required, activate the automatic check.</li> </ul>
<ul style="list-style-type: none"> <li>• <b>Cable off</b></li> </ul>	<ul style="list-style-type: none"> <li>• param.</li> </ul>	Entropy cable is off.	<ul style="list-style-type: none"> <li>• Connect the cable.</li> </ul>
<ul style="list-style-type: none"> <li>• <b>Checking sensor</b></li> </ul>	<ul style="list-style-type: none"> <li>• param., wavef.</li> </ul>	Sensor check is in progress.	<ul style="list-style-type: none"> <li>• Wait until the check is over. Check results are displayed.</li> </ul>
<ul style="list-style-type: none"> <li>• <b>Confirm electrode 1</b></li> <li>• <b>Confirm electrode 2</b></li> <li>• <b>Confirm electrode 3</b></li> </ul>	<ul style="list-style-type: none"> <li>• param.</li> </ul>	One of the sensor electrodes has poor contact.	<ul style="list-style-type: none"> <li>• Confirm proper sensor electrode 1, 2 or 3 contact as indicated in the message.</li> </ul>
<ul style="list-style-type: none"> <li>• <b>Confirm electrodes</b></li> </ul>	<ul style="list-style-type: none"> <li>• param.</li> </ul>	More than one of the sensor electrodes have poor contact.	<ul style="list-style-type: none"> <li>• Confirm proper electrode contact.</li> </ul>
<ul style="list-style-type: none"> <li>• <b>Entropy cable off</b></li> </ul>	<ul style="list-style-type: none"> <li>• al. area</li> </ul>	The Entropy sensor cable is not connected to the Entropy module.	<ul style="list-style-type: none"> <li>• Connect the Entropy cable to the Entropy module.</li> </ul>
<ul style="list-style-type: none"> <li>• <b>Entropy measurement removed</b></li> </ul>	<ul style="list-style-type: none"> <li>• al. area</li> </ul>	Acquisition module has been removed.	<ul style="list-style-type: none"> <li>• Connect the module if you want to restart the measurement.</li> </ul>
<ul style="list-style-type: none"> <li>• <b>Entropy RE high /Entropy RE low</b></li> </ul>	<ul style="list-style-type: none"> <li>• al. area</li> </ul>	Measurement values are equal to or outside the alarm limits.	<ul style="list-style-type: none"> <li>• Check the patient status.</li> <li>• Adjust alarm limits if necessary.</li> <li>• Adjust drug titration.</li> </ul>
<ul style="list-style-type: none"> <li>• <b>Entropy SE high /Entropy SE low</b></li> </ul>	<ul style="list-style-type: none"> <li>• al. area</li> </ul>	Measurement values are equal to or outside the alarm limits.	<ul style="list-style-type: none"> <li>• Check the patient status.</li> <li>• Adjust alarm limits if necessary.</li> <li>• Adjust drug titration.</li> </ul>
<ul style="list-style-type: none"> <li>• <b>Entropy sensor check failed</b></li> </ul>	<ul style="list-style-type: none"> <li>• al. area</li> </ul>	The sensor has not passed the impedance check.	<ul style="list-style-type: none"> <li>• Check sensor placement and attachment.</li> <li>• Confirm proper contact of each electrode in the sensor.</li> <li>• Replace the sensor.</li> </ul>
<ul style="list-style-type: none"> <li>• <b>Entropy sensor off</b></li> </ul>	<ul style="list-style-type: none"> <li>• al. area</li> </ul>	The sensor is connected to the cable but not attached to the patient, or the sensor type is not correct.	<ul style="list-style-type: none"> <li>• Check that the sensor is properly attached to the patient.</li> <li>• Check that the sensor is an Entropy sensor.</li> </ul>
<ul style="list-style-type: none"> <li>• <b>Identical Entropy modules</b></li> </ul>	<ul style="list-style-type: none"> <li>• al. area</li> </ul>	There are two or more Entropy modules in the system.	<ul style="list-style-type: none"> <li>• Remove all but one Entropy module.</li> </ul>

Message	Location	Explanation	What to do
<ul style="list-style-type: none"> <li>• <b>Isoelectric EEG</b></li> </ul>	<ul style="list-style-type: none"> <li>• param., wavef.</li> </ul>	Isoelectric (flatline) EEG detected in Entropy measurement.	<ul style="list-style-type: none"> <li>• Check the patient status. The patient's anesthetic status may be unnecessarily deep.</li> </ul>
<ul style="list-style-type: none"> <li>• <b>Low signal</b></li> </ul>	<ul style="list-style-type: none"> <li>• param.</li> </ul>	Measured EEG signal is too low for reliable Entropy calculation.	<ul style="list-style-type: none"> <li>• Check sensor placement.</li> <li>• The patient may be in total suppression; check the patient status.</li> </ul>
<ul style="list-style-type: none"> <li>• <b>No Entropy sensor</b></li> </ul>	<ul style="list-style-type: none"> <li>• al. area</li> </ul>	The sensor is not connected to the cable, or the sensor and cable are not compatible.	<ul style="list-style-type: none"> <li>• Check connection between Entropy sensor and cable.</li> <li>• Check that the cable and sensor are compatible.</li> </ul>
<ul style="list-style-type: none"> <li>• <b>No sensor</b></li> </ul>	<ul style="list-style-type: none"> <li>• al. area</li> </ul>	The sensor is not connected to the cable, or the sensor and cable are not compatible.	<ul style="list-style-type: none"> <li>• Check connection between Entropy sensor and cable.</li> <li>• Check that the cable and sensor are compatible.</li> </ul>
<ul style="list-style-type: none"> <li>• <b>Noise</b></li> </ul>	<ul style="list-style-type: none"> <li>• wavef.</li> </ul>	Unreliable Entropy calculation or distorted EEG waveform may appear during electrosurgery or other high frequency noise.	<ul style="list-style-type: none"> <li>• Interpret Entropy values with caution.</li> </ul>
<ul style="list-style-type: none"> <li>• <b>Sensor check failed</b></li> </ul>	<ul style="list-style-type: none"> <li>• param.</li> </ul>	The sensor has not passed the impedance check.	<ul style="list-style-type: none"> <li>• Check sensor placement and attachment.</li> <li>• Confirm proper contact of each electrode in the sensor.</li> <li>• Replace the sensor.</li> </ul>
<ul style="list-style-type: none"> <li>• <b>Sensor off</b></li> </ul>	<ul style="list-style-type: none"> <li>• param.</li> </ul>	The sensor is connected to the cable but not attached to the patient, or the sensor type is not correct.	<ul style="list-style-type: none"> <li>• Check that the sensor is properly attached to the patient.</li> <li>• Check that the sensor is an Entropy sensor.</li> </ul>
<ul style="list-style-type: none"> <li>• <b>Starting up</b></li> </ul>	<ul style="list-style-type: none"> <li>• param.</li> </ul>	The monitor is collecting data to start the measurement.	<ul style="list-style-type: none"> <li>• Wait for about one minute. Entropy values appear automatically.</li> </ul>

## Messages related to NMT measurement

For information regarding alarm priorities and escalation times, see the supplemental information manual.

Make sure you are familiar with the generic layout of the screen. This will help you identify where on screen the following messages appear. The message location is indicated with the following abbreviations:

- al. area = alarm area
- param. = parameter window
- report = report view
- wavef. = waveform area

Message	Location	Explanation	What to do
<ul style="list-style-type: none"> <li>• <b>Block recovery</b></li> </ul>	<ul style="list-style-type: none"> <li>• al. area</li> </ul>	Count number has reached the value you have selected for the recovery note function.	<ul style="list-style-type: none"> <li>• Check the patient status.</li> </ul>
<ul style="list-style-type: none"> <li>• <b>Check electrodes</b></li> </ul>	<ul style="list-style-type: none"> <li>• param.</li> </ul>	Adjusted stimulus current could not be delivered properly due to a broken connection of the stimulating electrode or cable.	<ul style="list-style-type: none"> <li>• Check the white and brown stimulating electrodes and their connections.</li> <li>• Check the cable.</li> <li>• Change the cable if necessary.</li> </ul>
<ul style="list-style-type: none"> <li>• <b>EMG electrodes off</b></li> </ul>	<ul style="list-style-type: none"> <li>• param.</li> </ul>	The EMG recording electrodes are off.	<ul style="list-style-type: none"> <li>• Attach the electrodes to continue or start the measurement.</li> </ul>
<ul style="list-style-type: none"> <li>• <b>Identical NMT modules</b></li> </ul>	<ul style="list-style-type: none"> <li>• al. area</li> </ul>	There are two or more NMT modules in the system.	<ul style="list-style-type: none"> <li>• Remove all but one NMT module.</li> </ul>
<ul style="list-style-type: none"> <li>• <b>Measurement off</b></li> </ul>	<ul style="list-style-type: none"> <li>• param.</li> </ul>	The measurement has been stopped.	<ul style="list-style-type: none"> <li>• Restart the measurement if required.</li> </ul>
<ul style="list-style-type: none"> <li>• <b>NMT cable removed</b></li> <li>• <b>Cable off</b></li> </ul>	<ul style="list-style-type: none"> <li>• al. area</li> <li>• param.</li> </ul>	The cable has been disconnected from the module.	<ul style="list-style-type: none"> <li>• Reconnect the cable if you want to restart the measurement.</li> </ul>
<ul style="list-style-type: none"> <li>• <b>NMT measurement removed</b></li> </ul>	<ul style="list-style-type: none"> <li>• al. area</li> </ul>	Acquisition module has been removed.	<ul style="list-style-type: none"> <li>• Connect the module if you want to restart the measurement.</li> </ul>
<ul style="list-style-type: none"> <li>• <b>Reference not stable</b></li> </ul>	<ul style="list-style-type: none"> <li>• param.</li> </ul>	The deviation between the four reference search twitches is too big.	<ul style="list-style-type: none"> <li>• Stop measurement, reposition electrodes and restart the measurement.</li> </ul>
<ul style="list-style-type: none"> <li>• <b>Regional Block</b></li> </ul>	<ul style="list-style-type: none"> <li>• param.</li> </ul>	Regional block stimulation is in progress.	<ul style="list-style-type: none"> <li>• Wait until the stimulation is completed.</li> </ul>
<ul style="list-style-type: none"> <li>• <b>Response too weak</b></li> </ul>	<ul style="list-style-type: none"> <li>• param.</li> </ul>	The measurement cannot be performed because the response is too weak.	<ul style="list-style-type: none"> <li>• Check electrode placement and connections.</li> <li>• Replace dry electrodes.</li> <li>• Check that the stimulus current is not too weak.</li> </ul>
<ul style="list-style-type: none"> <li>• <b>Setting reference</b></li> </ul>	<ul style="list-style-type: none"> <li>• param.</li> </ul>	Automatic reference search is in progress.	<ul style="list-style-type: none"> <li>• Wait until the reference search is completed.</li> </ul>
<ul style="list-style-type: none"> <li>• <b>Supramax not found</b></li> </ul>	<ul style="list-style-type: none"> <li>• param.</li> </ul>	Supramaximal stimulus current was not found. 70 mA is used as stimulus current.	<ul style="list-style-type: none"> <li>• Stop measurement, reposition the stimulating or recording electrodes and restart the measurement.</li> </ul>
<ul style="list-style-type: none"> <li>• <b>Supramax search</b></li> </ul>	<ul style="list-style-type: none"> <li>• param.</li> </ul>	Supramaximal stimulus current search is in progress.	<ul style="list-style-type: none"> <li>• Wait until the search is completed.</li> </ul>
<ul style="list-style-type: none"> <li>• <b>TETANIC</b></li> </ul>	<ul style="list-style-type: none"> <li>• param.</li> </ul>	Tetanic stimulation is in progress.	<ul style="list-style-type: none"> <li>• Wait until the stimulation is completed.</li> </ul>

## Messages related to EEG and AEP measurements

For information regarding alarm priorities and escalation times, see the supplemental information manual.

Make sure you are familiar with the generic layout of the screen. This will help you identify where on screen the following messages appear. The message location is indicated with the following abbreviations:

- al. area = alarm area
- param. = parameter window
- report = report view
- wavef. = waveform area

Message	Location	Explanation	What to do
• <b>AEP stimulation on</b>	• param.	The measurement is being performed and clicks are being delivered to the headphones.	<ul style="list-style-type: none"> <li>• Wait until the stimulation is completed.</li> </ul>
• <b>Artifacts</b>	• param.	Electrodes are poorly connected, or electrical interference is coupling to electrode cables.	<ul style="list-style-type: none"> <li>• Check the electrodes and their impedances.</li> <li>• Remove the sources of noise, if necessary.</li> </ul>
• <b>Big contact difference</b>	• param.	The electrode impedance check fails.	<ul style="list-style-type: none"> <li>• Check the contact quality from the active and baseline (+ and -) electrodes establishment to ensure measurement from the same noise signal.</li> <li>• Perform a new electrode impedance check.</li> </ul>
• <b>Check GND electrode</b>	• param.	The ground electrode impedance is over 5 kOhm.	<ul style="list-style-type: none"> <li>• Check the contact quality from the ground electrode establishment.</li> <li>• If necessary, change the electrode.</li> <li>• Perform a new electrode impedance check.</li> </ul>
• <b>Checking electrodes</b>	• param.	Electrode impedance is being measured and EEG analysis is stopped for a few seconds.	<ul style="list-style-type: none"> <li>• Wait until the electrode impedance check is completed.</li> </ul>
<ul style="list-style-type: none"> <li>• <b>EEG leads off</b></li> <li>• <b>Leads off</b></li> </ul>	<ul style="list-style-type: none"> <li>• al. area</li> <li>• param.</li> </ul>	Leads are not connected.	<ul style="list-style-type: none"> <li>• Reconnect the disconnected headbox leads.</li> </ul>
• <b>EEG measurement off</b>	• param.	The measurement has been stopped.	<ul style="list-style-type: none"> <li>• Restart the measurement if required.</li> </ul>
• <b>EEG measurement removed</b>	• al. area	Acquisition module has been removed.	<ul style="list-style-type: none"> <li>• Connect the module if you want to restart the measurement.</li> </ul>
• <b>Electrodes OK</b>	• param.	Electrode impedance is below 5 kOhm.	<ul style="list-style-type: none"> <li>• You can continue the measurement.</li> </ul>

Message	Location	Explanation	What to do
• <b>Headbox off</b>	• param.	Headbox is not connected.	• Connect the headbox.
• <b>High EMG</b>	• param.	High frontal muscle activity may disturb the EEG measurement.	• Calm the patient.
• <b>Identical EEG modules</b>	• al. area	There are two or more EEG modules in the system.	• Remove all but one EEG module.
• <b>Poor electr. contact</b>	• param.	Electrode impedance is over 5 kOhm.	<ul style="list-style-type: none"> <li>• Press the electrode to improve connection.</li> <li>• Change the electrode.</li> <li>• Check the impedance.</li> </ul>

## Messages related to BIS measurement

For information regarding alarm priorities and escalation times, see the supplemental information manual.

Make sure you are familiar with the generic layout of the screen. This will help you identify where on screen the following messages appear. The message location is indicated with the following abbreviations:

- al. area = alarm area
- param. = parameter window
- report = report view
- wavef. = waveform area

Message	Location	Explanation	What to do
• <b>Apply sensor</b>	• param.	The sensor connection to the patient may be loose.	• Press the BIS sensor electrodes to improve connection.
• <b>Artifact</b>	• param., wavef.	Signals contain noise or artifact.	<ul style="list-style-type: none"> <li>• Check sensor contact.</li> <li>• Remove sources of excessive noise.</li> </ul>
• <b>Automatic check off</b>	• param.	Automatic sensor check has been turned off.	• If required, activate the automatic check.
• <b>BIS cable off</b>	• al. area	Cable is disconnected from the module.	• Connect the cable.
• <b>BIS DSC error</b>	• al. area	The BISx is not communicating or operating properly.	<ul style="list-style-type: none"> <li>• Test the BISx.</li> <li>• If the problem persists, contact authorized service personnel.</li> </ul>
• <b>BIS high / BIS low</b>	• al. area	Measurement values are equal to or outside the alarm limits.	<ul style="list-style-type: none"> <li>• Check the patient status.</li> <li>• Check the dosage of anesthetics.</li> <li>• Adjust alarm limits if necessary.</li> </ul>

Message	Location	Explanation	What to do
<ul style="list-style-type: none"> <li>• <b>BIS measurement removed</b></li> </ul>	<ul style="list-style-type: none"> <li>• al. area</li> </ul>	The module or BISx is disconnected.	<ul style="list-style-type: none"> <li>• Connect the module or BISx to start the measurement.</li> </ul>
<ul style="list-style-type: none"> <li>• <b>BIS module error</b></li> </ul>	<ul style="list-style-type: none"> <li>• al. area</li> </ul>	The module is not working properly.	<ul style="list-style-type: none"> <li>• Check cable and connections.</li> <li>• Replace the BISx.</li> <li>• Replace the module.</li> <li>• If the problem persists, contact authorized service personnel.</li> </ul>
<ul style="list-style-type: none"> <li>• <b>BIS sensor check failed</b></li> </ul>	<ul style="list-style-type: none"> <li>• al. area</li> </ul>	The sensor has not passed the impedance check.	<ul style="list-style-type: none"> <li>• Check sensor placement and attachment.</li> </ul>
<ul style="list-style-type: none"> <li>• <b>BIS sensor expired</b></li> </ul>	<ul style="list-style-type: none"> <li>• al. area</li> </ul>	The sensor date has expired, the sensor has been used too many times, or the validity time for the sensor cannot be determined.	<ul style="list-style-type: none"> <li>• Replace the sensor.</li> </ul>
<ul style="list-style-type: none"> <li>• <b>Cable off</b></li> </ul>	<ul style="list-style-type: none"> <li>• param., wavef.</li> </ul>	Cable is disconnected from the module.	<ul style="list-style-type: none"> <li>• Connect the cable.</li> </ul>
<ul style="list-style-type: none"> <li>• <b>Checking sensor</b></li> </ul>	<ul style="list-style-type: none"> <li>• param., wavef.</li> </ul>	Sensor check is in progress.	<ul style="list-style-type: none"> <li>• Wait until the check is over. Check results are displayed.</li> </ul>
<ul style="list-style-type: none"> <li>• <b>DSC error</b></li> </ul>	<ul style="list-style-type: none"> <li>• param., wavef.</li> </ul>	The BISx is not communicating or operating properly.	<ul style="list-style-type: none"> <li>• Test the BISx.</li> <li>• If the problem persists, contact authorized service personnel.</li> </ul>
<ul style="list-style-type: none"> <li>• <b>High BIS impedance</b></li> </ul>	<ul style="list-style-type: none"> <li>• al. area</li> </ul>	Electrode impedance is too high.	<ul style="list-style-type: none"> <li>• Check electrode connections.</li> </ul>
<ul style="list-style-type: none"> <li>• <b>Identical BIS modules</b></li> </ul>	<ul style="list-style-type: none"> <li>• al. area</li> </ul>	There are two or more BIS modules in the system.	<ul style="list-style-type: none"> <li>• Remove all but one BIS module.</li> </ul>
<ul style="list-style-type: none"> <li>• <b>Incompatible DSC</b></li> </ul>	<ul style="list-style-type: none"> <li>• param.</li> </ul>	The hardware/ software is not compatible with the BISx.	<ul style="list-style-type: none"> <li>• Check and change the BISx.</li> </ul>
<ul style="list-style-type: none"> <li>• <b>Incompatible sensor</b></li> </ul>	<ul style="list-style-type: none"> <li>• param., wavef.</li> </ul>	The sensor used is not a BIS sensor.	<ul style="list-style-type: none"> <li>• Make sure that you are using a Covidien BIS sensor.</li> </ul>
<ul style="list-style-type: none"> <li>• <b>Module error</b></li> </ul>	<ul style="list-style-type: none"> <li>• param., wavef.</li> </ul>	The module is not working properly.	<ul style="list-style-type: none"> <li>• Check cable and connections.</li> <li>• Replace the BISx.</li> <li>• Replace the module.</li> <li>• If the problem persists, contact authorized service personnel.</li> </ul>
<ul style="list-style-type: none"> <li>• <b>No BIS sensor</b></li> <li>• <b>No sensor</b></li> </ul>	<ul style="list-style-type: none"> <li>• al. area</li> <li>• param., wavef.</li> </ul>	BIS: The sensor is not connected to the digital signal processing unit BISx.	<ul style="list-style-type: none"> <li>• Check the connection between sensor and BISx, and sensor and PIC (patient interface cable).</li> </ul>
<ul style="list-style-type: none"> <li>• <b>Poor signal</b></li> </ul>	<ul style="list-style-type: none"> <li>• param., wavef.</li> </ul>	The BIS cannot be calculated because the SQI is below 50.	<ul style="list-style-type: none"> <li>• Check electrode connections.</li> </ul>

Message	Location	Explanation	What to do
<ul style="list-style-type: none"> <li>• <b>Replace sensor</b></li> </ul>	<ul style="list-style-type: none"> <li>• param.</li> </ul>	The sensor date has expired, the sensor has been used too many times, or the validity time for the sensor cannot be determined.	<ul style="list-style-type: none"> <li>• Replace the sensor.</li> </ul>
<ul style="list-style-type: none"> <li>• <b>Sensor check failed</b></li> </ul>	<ul style="list-style-type: none"> <li>• param., wavf.</li> </ul>	The sensor has not passed the impedance check.	<ul style="list-style-type: none"> <li>• Check sensor placement and attachment.</li> <li>• Press each electrode in the sensor.</li> <li>• Replace the sensor.</li> </ul>
<ul style="list-style-type: none"> <li>• <b>Testing DSC</b></li> </ul>	<ul style="list-style-type: none"> <li>• param., wavf.</li> </ul>	The BISx test has been activated.	<ul style="list-style-type: none"> <li>• Wait until the check is completed.</li> </ul>

## Messages related to TC measurement

For information regarding alarm priorities and escalation times, see the supplemental information manual.

Make sure you are familiar with the generic layout of the screen. This will help you identify where on screen the following messages appear. The message location is indicated with the following abbreviations:

- al. area = alarm area
- param. = parameter window
- report = report view
- wavf. = waveform area

Message	Location	Explanation	What to do
<ul style="list-style-type: none"> <li>• <b>Calibrating</b></li> </ul>	<ul style="list-style-type: none"> <li>• param.</li> </ul>	Calibration is in progress.	<ul style="list-style-type: none"> <li>• No action required.</li> </ul>
<ul style="list-style-type: none"> <li>• <b>Calibration error</b></li> </ul>	<ul style="list-style-type: none"> <li>• param.</li> </ul>	Unsuccessful calibration.	<ul style="list-style-type: none"> <li>• Authorized service personnel should repeat the calibration procedure.</li> </ul>
<ul style="list-style-type: none"> <li>• <b>Connecting</b></li> </ul>	<ul style="list-style-type: none"> <li>• param.</li> </ul>	Connection to the interfaced device is being established.	<ul style="list-style-type: none"> <li>• No action required.</li> </ul>
<ul style="list-style-type: none"> <li>• <b>Ext device error</b></li> </ul>	<ul style="list-style-type: none"> <li>• param.</li> </ul>	Interfaced device should be checked.	<ul style="list-style-type: none"> <li>• Check the interfaced device.</li> <li>• If the problem persists, contact authorized service personnel.</li> </ul>
<ul style="list-style-type: none"> <li>• <b>No ext device</b></li> </ul>	<ul style="list-style-type: none"> <li>• param.</li> </ul>	Interfaced device should be checked.	<ul style="list-style-type: none"> <li>• Check the interfaced device.</li> <li>• If the problem persists, contact authorized service personnel.</li> </ul>
<ul style="list-style-type: none"> <li>• <b>Not calibrated</b></li> </ul>	<ul style="list-style-type: none"> <li>• param.</li> </ul>	Measurement needs to be calibrated.	<ul style="list-style-type: none"> <li>• Perform calibration.</li> </ul>
<ul style="list-style-type: none"> <li>• <b>Ready</b></li> </ul>	<ul style="list-style-type: none"> <li>• param.</li> </ul>	Measurement is ready.	<ul style="list-style-type: none"> <li>• No action required.</li> </ul>

Message	Location	Explanation	What to do
<ul style="list-style-type: none"> <li>• <b>TC measurement removed</b></li> </ul>	<ul style="list-style-type: none"> <li>• al. area</li> </ul>	Interfaced module has been removed.	<ul style="list-style-type: none"> <li>• Connect the module if you want to restart the measurement.</li> </ul>
<ul style="list-style-type: none"> <li>• <b>TC pCO2 high / TC pCO2 low</b></li> </ul>	<ul style="list-style-type: none"> <li>• al. area</li> </ul>	Measurement values are equal to or outside the alarm limits.	<ul style="list-style-type: none"> <li>• Check the patient status.</li> <li>• Adjust alarm limits if necessary.</li> </ul>
<ul style="list-style-type: none"> <li>• <b>TC pO2 high / TC pO2 low</b></li> </ul>	<ul style="list-style-type: none"> <li>• al. area</li> </ul>	Measurement values are equal to or outside the alarm limits.	<ul style="list-style-type: none"> <li>• Check the patient status.</li> <li>• Adjust alarm limits if necessary.</li> </ul>
<ul style="list-style-type: none"> <li>• <b>TC timer expired</b></li> </ul>	<ul style="list-style-type: none"> <li>• al. area</li> </ul>	The time set on the interfaced device after a successful calibration has now expired.	<ul style="list-style-type: none"> <li>• Change the sensor site and reset the timer.</li> </ul>
<ul style="list-style-type: none"> <li>• <b>TC Tsensor high</b></li> <li>• <b>Tsensor high</b></li> </ul>	<ul style="list-style-type: none"> <li>• al. area</li> <li>• param.</li> </ul>	Limit for sensor temperature is set on the interfaced device.	<ul style="list-style-type: none"> <li>• Check the interfaced device.</li> <li>• If the problem persists, contact authorized service personnel.</li> </ul>

## Messages related to trends, snapshots, and laboratory data

For information regarding alarm priorities and escalation times, see the supplemental information manual.

Make sure you are familiar with the generic layout of the screen. This will help you identify where on screen the following messages appear. The message location is indicated with the following abbreviations:

- al. area = alarm area
- param. = parameter window
- report = report view
- wavef. = waveform area

Message	Location	Explanation	What to do
<ul style="list-style-type: none"> <li>• <b>End of 20 min trend data</b></li> <li>• <b>End of High Resolution trend</b></li> </ul>	<ul style="list-style-type: none"> <li>• al. area</li> </ul>	There is more trend data available but not with this resolution.	<ul style="list-style-type: none"> <li>• Change the time resolution in graphic trends to be more than 20 minutes (e.g., 1 hour, 2 hours).</li> <li>• Scroll the trends to see past data.</li> </ul>
<ul style="list-style-type: none"> <li>• <b>Lab data available</b></li> </ul>	<ul style="list-style-type: none"> <li>• al. area</li> </ul>	Unity Network Interface Device (ID): Interfaced device has sent a new set of laboratory data to the monitor.	<ul style="list-style-type: none"> <li>• Save the new data.</li> </ul>



Message	Location	Explanation	What to do
<ul style="list-style-type: none"> <li>• <b>Lab data interface failed</b></li> </ul>	<ul style="list-style-type: none"> <li>• al. area</li> </ul>	Unity Network Interface Device (ID): There is a communication failure or error between the Unity Network Interface Device (ID) and the interfaced device.	<ul style="list-style-type: none"> <li>• Check the interfaced device.</li> <li>• If the problem persists, contact authorized service personnel.</li> </ul>
<ul style="list-style-type: none"> <li>• <b>Mark xxx</b></li> <li>• where xxx = snapshot sequence number</li> </ul>	<ul style="list-style-type: none"> <li>• alarm area</li> </ul>	A snapshot has been taken manually.	<ul style="list-style-type: none"> <li>• No action required.</li> </ul>
<ul style="list-style-type: none"> <li>• <b>Snapshot created</b></li> </ul>	<ul style="list-style-type: none"> <li>• al. area</li> </ul>	A snapshot has been created.	<ul style="list-style-type: none"> <li>• No action required.</li> </ul>
<ul style="list-style-type: none"> <li>• <b>Snapshot memory full. Oldest snapshot erased.</b></li> </ul>	<ul style="list-style-type: none"> <li>• al. area</li> </ul>	You are trying to save a snapshot but the memory capacity is full.	<ul style="list-style-type: none"> <li>• No action required.</li> </ul>
<ul style="list-style-type: none"> <li>• <b>ST snapshot created</b></li> </ul>	<ul style="list-style-type: none"> <li>• al. area</li> </ul>	ST snapshot created.	<ul style="list-style-type: none"> <li>• No action required.</li> </ul>
<ul style="list-style-type: none"> <li>• <b>ST snapshot memory full. Oldest ST snapshot erased.</b></li> </ul>	<ul style="list-style-type: none"> <li>• al. area</li> </ul>	You are trying to save an ST snapshot but the memory capacity is full.	<ul style="list-style-type: none"> <li>• No action required.</li> </ul>
<ul style="list-style-type: none"> <li>• <b>Sweep Speed Changed</b></li> </ul>	<ul style="list-style-type: none"> <li>• wavef.</li> </ul>	Sweep speed of the realtime waveform has changed.	<ul style="list-style-type: none"> <li>• No action required.</li> </ul>
<ul style="list-style-type: none"> <li>• <b>Waveform available only for 2min and 4min time scales</b></li> </ul>	<ul style="list-style-type: none"> <li>• wavef.</li> </ul>	High Resolution trends license is configured for HR, Resp, SpO ₂ , CO ₂ and MAP.	<ul style="list-style-type: none"> <li>• Change trend resolution to 2 minute or 4 minute time scale for the affected parameter.</li> </ul>

## Messages related to various situations

For information regarding alarm priorities and escalation times, see the supplemental information manual.

Make sure you are familiar with the generic layout of the screen. This will help you identify where on screen the following messages appear. The message location is indicated with the following abbreviations:

- al. area = alarm area
- param. = parameter window
- report = report view
- wavef. = waveform area

Message	Location	Explanation	What to do
<ul style="list-style-type: none"> <li>• <b>ADT server communication failure</b></li> </ul>	<ul style="list-style-type: none"> <li>• al. area</li> </ul>	An error occurred when trying to search for patient on the ADT server.	<ul style="list-style-type: none"> <li>• Check the network connectivity.</li> <li>• Retry loading from the network.</li> <li>• If the problem persists, contact authorized service personnel.</li> </ul>
<ul style="list-style-type: none"> <li>• <b>Alarm setup changed remotely</b></li> </ul>	<ul style="list-style-type: none"> <li>• al. area</li> </ul>	The alarm setup is retrieved from the telemetry server or central station.	<ul style="list-style-type: none"> <li>• Check the alarm settings and adjust if necessary.</li> </ul>

Message	Location	Explanation	What to do
<ul style="list-style-type: none"> <li>• <b>Alarm volume changed</b></li> </ul>	<ul style="list-style-type: none"> <li>• al. area</li> </ul>	The network connection is lost, and the local alarm volume is increased.	<ul style="list-style-type: none"> <li>• Readjust volume if desired.</li> </ul>
<ul style="list-style-type: none"> <li>• <b>Alarms acknowledged remotely</b></li> </ul>	<ul style="list-style-type: none"> <li>• al. area</li> </ul>	The alarms have been acknowledged from the central station.	<ul style="list-style-type: none"> <li>• No action required but you may wish to confirm in alarm history which alarm has been acknowledged.</li> </ul>
<ul style="list-style-type: none"> <li>• <b>Alarms audio paused remotely</b></li> </ul>	<ul style="list-style-type: none"> <li>• al. area</li> </ul>	The alarms were remotely paused from the central station.	<ul style="list-style-type: none"> <li>• You can activate the alarms by pressing the audio pause key.</li> </ul>
<ul style="list-style-type: none"> <li>• <b>Alarms audio paused from telemetry</b></li> </ul>	<ul style="list-style-type: none"> <li>• al. area</li> </ul>	The alarms were remotely paused from the telemetry transmitter.	<ul style="list-style-type: none"> <li>• You can activate the alarms by pressing the audio pause key.</li> </ul>
<ul style="list-style-type: none"> <li>• <b>All monitors disconnected</b></li> </ul>	<ul style="list-style-type: none"> <li>• al. area</li> </ul>	The monitor is disconnected from the network.	<ul style="list-style-type: none"> <li>• Re-establish connection.</li> <li>• If the problem persists, contact authorized service personnel.</li> </ul>
<ul style="list-style-type: none"> <li>• <b>Application error: iPanel</b></li> </ul>	<ul style="list-style-type: none"> <li>• al. area</li> </ul>	Connection to iPanel was lost.	<ul style="list-style-type: none"> <li>• Re-establish the connection.</li> <li>• If the problem persists, contact authorized service personnel.</li> </ul>
<ul style="list-style-type: none"> <li>• <b>Application error: pdf</b></li> </ul>	<ul style="list-style-type: none"> <li>• al. area</li> </ul>	PDF viewer closes unexpectedly.	<ul style="list-style-type: none"> <li>• Try to open the MUSE 12SL report again.</li> <li>• If the problem persists, contact authorized service personnel.</li> </ul>
<ul style="list-style-type: none"> <li>• <b>Application error: Webmin</b></li> </ul>	<ul style="list-style-type: none"> <li>• al. area</li> </ul>	Webmin application closes unexpectedly.	<ul style="list-style-type: none"> <li>• Try to open Webmin again.</li> <li>• If the problem persists, contact authorized service personnel.</li> </ul>
<ul style="list-style-type: none"> <li>• <b>Audio set OFF remotely</b></li> </ul>	<ul style="list-style-type: none"> <li>• al. area</li> </ul>	The alarms have been turned off from the central station.	<ul style="list-style-type: none"> <li>• You can change the selection through <b>Alarm Setup &gt; Audible &amp; Visual</b>.</li> </ul>
<ul style="list-style-type: none"> <li>• <b>Barcode scanned</b></li> </ul>	<ul style="list-style-type: none"> <li>• al. area</li> </ul>	All data has been successfully stored to the monitor.	<ul style="list-style-type: none"> <li>• No action required.</li> </ul>
<ul style="list-style-type: none"> <li>• <b>Barcode too long</b></li> </ul>	<ul style="list-style-type: none"> <li>• al. area</li> </ul>	The maximum length of the barcode has been exceeded.	<ul style="list-style-type: none"> <li>• Verify the information read by the barcode reader and edit if necessary.</li> </ul>
<ul style="list-style-type: none"> <li>• <b>Battery A failure</b></li> <li>• <b>Battery B failure</b></li> </ul>	<ul style="list-style-type: none"> <li>• al. area</li> </ul>	Battery A or B is faulty.	<ul style="list-style-type: none"> <li>• Replace the battery if necessary.</li> </ul>
<ul style="list-style-type: none"> <li>• <b>Battery failure</b></li> </ul>	<ul style="list-style-type: none"> <li>• al. area</li> </ul>	The monitor battery is faulty.	<ul style="list-style-type: none"> <li>• Replace the battery if necessary.</li> </ul>

Message	Location	Explanation	What to do
<ul style="list-style-type: none"> <li>• <b>Battery A temperature high</b></li> <li>• <b>Battery B temperature high</b></li> </ul>	<ul style="list-style-type: none"> <li>• al. area</li> </ul>	Battery A or B temperature is too high.	<ul style="list-style-type: none"> <li>• Replace the battery.</li> <li>• If the problem persists, contact authorized service personnel.</li> </ul>
<ul style="list-style-type: none"> <li>• <b>Battery temperature high</b></li> </ul>	<ul style="list-style-type: none"> <li>• al. area</li> </ul>	The battery's temperature is too high.	<ul style="list-style-type: none"> <li>• Replace the battery.</li> <li>• If the problem persists, contact authorized service personnel.</li> </ul>
<ul style="list-style-type: none"> <li>• <b>&lt;Bed&gt; Monitor disconnected</b></li> </ul>	<ul style="list-style-type: none"> <li>• al. area</li> </ul>	The monitor with alarm notification enabled is disconnected from the network.	<ul style="list-style-type: none"> <li>• Re-establish the connection.</li> </ul>
<ul style="list-style-type: none"> <li>• <b>Call Service: Text(s) missing</b></li> </ul>	<ul style="list-style-type: none"> <li>• al. area</li> </ul>	The software text is missing in this language; the text file may be corrupted.	<ul style="list-style-type: none"> <li>• Contact authorized service personnel.</li> </ul>
<ul style="list-style-type: none"> <li>• <b>Case ended</b></li> </ul>	<ul style="list-style-type: none"> <li>• al. area</li> </ul>	OR and PACU software packages: The current case has just been ended.	<ul style="list-style-type: none"> <li>• No action required.</li> </ul>
<ul style="list-style-type: none"> <li>• <b>Case started</b></li> </ul>	<ul style="list-style-type: none"> <li>• al. area</li> </ul>	OR and PACU software packages: A new case has just been started.	<ul style="list-style-type: none"> <li>• No action required.</li> </ul>
<ul style="list-style-type: none"> <li>• <b>Check PDM battery</b></li> </ul>	<ul style="list-style-type: none"> <li>• al. area</li> </ul>	PDM battery is not working properly.	<ul style="list-style-type: none"> <li>• Check and replace or remove the battery.</li> </ul>
<ul style="list-style-type: none"> <li>• <b>Condition battery A</b></li> <li>• <b>Condition battery B</b></li> </ul>	<ul style="list-style-type: none"> <li>• al. area</li> </ul>	Battery A or B is not working properly.	<ul style="list-style-type: none"> <li>• Replace or remove the battery.</li> </ul>
<ul style="list-style-type: none"> <li>• <b>Condition monitor battery</b></li> </ul>	<ul style="list-style-type: none"> <li>• al. area</li> </ul>	Battery is not working properly.	<ul style="list-style-type: none"> <li>• Replace or remove the battery.</li> </ul>
<ul style="list-style-type: none"> <li>• <b>Configuration change(s)</b></li> </ul>	<ul style="list-style-type: none"> <li>• al. area</li> </ul>	The loaded configuration has changed from the previous one.	<ul style="list-style-type: none"> <li>• No action required, but you may wish to check the settings.</li> </ul>
<ul style="list-style-type: none"> <li>• <b>Configuration changes. Restart required.</b></li> </ul>	<ul style="list-style-type: none"> <li>• al. area</li> </ul>	The configuration has changed.	<ul style="list-style-type: none"> <li>• Restart the monitor.</li> </ul>
<ul style="list-style-type: none"> <li>• <b>Configuration error(s)</b></li> </ul>	<ul style="list-style-type: none"> <li>• al. area</li> </ul>	One or more errors have been detected in the configuration.	<ul style="list-style-type: none"> <li>• Contact authorized service personnel.</li> </ul>
<ul style="list-style-type: none"> <li>• <b>Connecting Measurement</b></li> </ul>	<ul style="list-style-type: none"> <li>• al. area</li> </ul>	An acquisition module has been connected.	<ul style="list-style-type: none"> <li>• No action required.</li> </ul>
<ul style="list-style-type: none"> <li>• <b>Connecting telemetry transmitter</b></li> </ul>	<ul style="list-style-type: none"> <li>• al. area</li> </ul>	The monitor is connecting to a telemetry transmitter.	<ul style="list-style-type: none"> <li>• No action required.</li> </ul>
<ul style="list-style-type: none"> <li>• <b>Countdown timer expired</b></li> </ul>	<ul style="list-style-type: none"> <li>• al. area</li> </ul>	User set countdown timer has expired.	<ul style="list-style-type: none"> <li>• Reset the timer if required.</li> </ul>
<ul style="list-style-type: none"> <li>• <b>Entering standby</b></li> </ul>	<ul style="list-style-type: none"> <li>• al. area</li> </ul>	Activate standby has been selected.	<ul style="list-style-type: none"> <li>• No action required.</li> </ul>

Message	Location	Explanation	What to do
<ul style="list-style-type: none"> <li><b>Error 1: PMC update failed. Turn the monitor off and then on again.</b></li> </ul>	<ul style="list-style-type: none"> <li>start-up screen</li> </ul>	Unsuccessful PMC update.	<ul style="list-style-type: none"> <li>Turn the monitor off and then on again.</li> <li>If the problem persists, contact authorized service personnel.</li> </ul>
<ul style="list-style-type: none"> <li><b>Error 2: PMC update requires a mains supply. Plug in the power cord and turn the monitor off and then on again.</b></li> </ul>	<ul style="list-style-type: none"> <li>start-up screen</li> </ul>	Unsuccessful PMC update.	<ul style="list-style-type: none"> <li>Plug in the power cord and turn the monitor off and then on again.</li> <li>If the problem persists, contact authorized service personnel.</li> </ul>
<ul style="list-style-type: none"> <li><b>External alarm light disconnect. Check USB connection.</b></li> </ul>	<ul style="list-style-type: none"> <li>al.area</li> </ul>	There is a communication error.	<ul style="list-style-type: none"> <li>Wait and see if the message disappears.</li> <li>Try selecting audio pause and see if the message disappears.</li> <li>If the problem persists, contact authorized service personnel.</li> </ul>
<ul style="list-style-type: none"> <li><b>Identical IP address noticed</b></li> </ul>	<ul style="list-style-type: none"> <li>al. area</li> </ul>	Two or more monitors have the same IP address.	<ul style="list-style-type: none"> <li>Contact authorized service personnel.</li> </ul>
<ul style="list-style-type: none"> <li><b>Identical unit &amp; bed name noticed</b></li> </ul>	<ul style="list-style-type: none"> <li>al. area</li> </ul>	Two or more monitors have the same unit and bed name.	<ul style="list-style-type: none"> <li>Contact authorized service personnel.</li> </ul>
<ul style="list-style-type: none"> <li><b>Incompatible Module</b></li> </ul>	<ul style="list-style-type: none"> <li>al. area</li> </ul>	The module is not compatible.	<ul style="list-style-type: none"> <li>Replace with compatible module. See the supplemental information manual.</li> <li>If the problem persists, contact authorized service personnel.</li> </ul>
<ul style="list-style-type: none"> <li><b>Incompatible TramRAC</b></li> </ul>	<ul style="list-style-type: none"> <li>al. area</li> </ul>	Incompatible Tram-Rac connected.	<ul style="list-style-type: none"> <li>Replace with compatible Tram-Rac module. See the supplemental information manual.</li> <li>If the problem persists, contact authorized service personnel.</li> </ul>
<ul style="list-style-type: none"> <li><b>Incorrect barcode value</b></li> </ul>	<ul style="list-style-type: none"> <li>al. area</li> </ul>	The barcode string differs from the defined values.	<ul style="list-style-type: none"> <li>Contact authorized service personnel.</li> </ul>
<ul style="list-style-type: none"> <li><b>Information Center busy</b></li> </ul>	<ul style="list-style-type: none"> <li>al. area</li> </ul>	S/5 Network has too many bed-to-bed connections.	<ul style="list-style-type: none"> <li>Try again later.</li> </ul>
<ul style="list-style-type: none"> <li><b>Information Center not responding</b></li> </ul>	<ul style="list-style-type: none"> <li>al. area</li> </ul>	S/5 Network is busy and the central station is not responding.	<ul style="list-style-type: none"> <li>Try again later.</li> </ul>
<ul style="list-style-type: none"> <li><b>Invalid barcode configuration</b></li> </ul>	<ul style="list-style-type: none"> <li>al. area</li> </ul>	The barcode configuration is not correct.	<ul style="list-style-type: none"> <li>Contact authorized service personnel.</li> </ul>
<ul style="list-style-type: none"> <li><b>License(s) expired</b></li> </ul>	<ul style="list-style-type: none"> <li>al. area</li> </ul>	One or more trial licenses have expired.	<ul style="list-style-type: none"> <li>Contact authorized service personnel.</li> </ul>

Message	Location	Explanation	What to do
<ul style="list-style-type: none"> <li>• <b>Loading completed</b></li> </ul>	<ul style="list-style-type: none"> <li>• al. area</li> </ul>	Loading or merging a case/patient from the S/5 Network was completed.	<ul style="list-style-type: none"> <li>• No action required.</li> </ul>
<ul style="list-style-type: none"> <li>• <b>Loading failed</b></li> </ul>	<ul style="list-style-type: none"> <li>• al. area</li> </ul>	Loading a case/patient from an acquisition module or network has been interrupted.	<ul style="list-style-type: none"> <li>• Check device or network cable connections.</li> </ul>
<ul style="list-style-type: none"> <li>• <b>Loading failed. Wrong patient</b></li> </ul>	<ul style="list-style-type: none"> <li>• al. area</li> </ul>	Merging a case from the S/5 Network was refused by the central station.	<ul style="list-style-type: none"> <li>• Check that the <b>Last Name</b>, <b>First Name</b> and <b>Medical Record Number</b> are identical on the monitor and central station, or that the monitor has no information in these fields.</li> </ul>
<ul style="list-style-type: none"> <li>• <b>Loading from network</b></li> </ul>	<ul style="list-style-type: none"> <li>• al. area</li> </ul>	Patient data is being loaded from the network.	<ul style="list-style-type: none"> <li>• No action required.</li> </ul>
<ul style="list-style-type: none"> <li>• <b>Loading from PDM / Loading from Tram</b></li> </ul>	<ul style="list-style-type: none"> <li>• al. area</li> </ul>	Patient data is being loaded from an acquisition module.	<ul style="list-style-type: none"> <li>• Wait.</li> </ul>
<ul style="list-style-type: none"> <li>• <b>Module voltage low</b></li> </ul>	<ul style="list-style-type: none"> <li>• al. area</li> </ul>	Parameters may not be working properly due to a technical fault in the monitor.	<ul style="list-style-type: none"> <li>• Check the patient status.</li> <li>• Contact authorized service personnel.</li> </ul>
<ul style="list-style-type: none"> <li>• <b>Monitor battery empty!</b></li> </ul>	<ul style="list-style-type: none"> <li>• al. area</li> </ul>	The monitor is used on battery power, and there is less than 5 minutes of charge left.	<ul style="list-style-type: none"> <li>• Charge the battery by using the monitor on mains power.</li> </ul>
<ul style="list-style-type: none"> <li>• <b>Monitor battery low</b></li> </ul>	<ul style="list-style-type: none"> <li>• al. area</li> </ul>	The monitor is used on battery power, and there is less than 20 minutes of charge left.	<ul style="list-style-type: none"> <li>• Charge the battery by using the monitor on mains power.</li> </ul>
<ul style="list-style-type: none"> <li>• <b>Monitor disconnected</b></li> </ul>	<ul style="list-style-type: none"> <li>• al. area</li> </ul>	The alarming monitor is disconnected from the network.	<ul style="list-style-type: none"> <li>• Re-establish the connection.</li> </ul>
<ul style="list-style-type: none"> <li>• <b>Monitor powering down!</b></li> </ul>	<ul style="list-style-type: none"> <li>• al. area</li> </ul>	The monitor is used on battery power and there is less than 10 seconds of charge left.	<ul style="list-style-type: none"> <li>• Charge the battery by using the monitor on mains power.</li> </ul>
<ul style="list-style-type: none"> <li>• <b>Network : &lt;central name&gt;</b></li> </ul>	<ul style="list-style-type: none"> <li>• al. area</li> </ul>	Connection to an iCentral is established.	<ul style="list-style-type: none"> <li>• No action required.</li> </ul>
<ul style="list-style-type: none"> <li>• <b>Network down</b></li> </ul>	<ul style="list-style-type: none"> <li>• al. area</li> </ul>	CARESCAPE Network connection has failed. B650: If the monitor is used with WLAN option, it is in shadow region and not connected to the network.	<ul style="list-style-type: none"> <li>• Try to re-establish the connection.</li> <li>• Contact authorized service personnel.</li> </ul>
<ul style="list-style-type: none"> <li>• <b>Network down: &lt;central name&gt;</b></li> </ul>	<ul style="list-style-type: none"> <li>• al. area</li> </ul>	The monitor has lost connection to an iCentral in the S/5 Network.	<ul style="list-style-type: none"> <li>• Check the network connections.</li> </ul>
<ul style="list-style-type: none"> <li>• <b>No battery backup in monitor</b></li> </ul>	<ul style="list-style-type: none"> <li>• al. area</li> </ul>	The monitor has the battery option but there is no battery inserted.	<ul style="list-style-type: none"> <li>• Insert a battery.</li> </ul>

Messages

Message	Location	Explanation	What to do
<ul style="list-style-type: none"> <li>• <b>No patients found</b></li> </ul>	<ul style="list-style-type: none"> <li>• al. area</li> </ul>	No patients were found when searching the ADT server.	<ul style="list-style-type: none"> <li>• Verify or change search criteria.</li> <li>• Manually enter demographic information.</li> </ul>
<ul style="list-style-type: none"> <li>• <b>No printer selected</b></li> </ul>	<ul style="list-style-type: none"> <li>• al. area</li> </ul>	There is no printer selected on the monitor.	<ul style="list-style-type: none"> <li>• Select a printer.</li> </ul>
<ul style="list-style-type: none"> <li>• <b>Patient admitted</b></li> </ul>	<ul style="list-style-type: none"> <li>• al. area</li> </ul>	ICU, NICU and ED software packages: The current patient has just been admitted.	<ul style="list-style-type: none"> <li>• No action required.</li> </ul>
<ul style="list-style-type: none"> <li>• <b>Patient discharged</b></li> </ul>	<ul style="list-style-type: none"> <li>• al. area</li> </ul>	ICU, NICU and ED software packages: The patient has just been discharged.	<ul style="list-style-type: none"> <li>• No action required.</li> </ul>
<ul style="list-style-type: none"> <li>• <b>PDM battery low</b></li> </ul>	<ul style="list-style-type: none"> <li>• al. area</li> </ul>	PDM: The PDM battery cannot be charged due to a power fault.	<ul style="list-style-type: none"> <li>• Allow PDM battery to charge.</li> <li>• If message persists, change battery.</li> <li>• If the problem persists, contact authorized service personnel.</li> </ul>
<ul style="list-style-type: none"> <li>• <b>PDM battery temp high</b></li> </ul>	<ul style="list-style-type: none"> <li>• al. area</li> </ul>	PDM: PDM battery temperature is over the limit.	<ul style="list-style-type: none"> <li>• Contact authorized service personnel.</li> </ul>
<ul style="list-style-type: none"> <li>• <b>PDM charging is denied</b></li> </ul>	<ul style="list-style-type: none"> <li>• al. area</li> </ul>	The PDM battery cannot be charged because the internal temperature of the monitor is too high.	<ul style="list-style-type: none"> <li>• Contact authorized service personnel.</li> </ul>
<ul style="list-style-type: none"> <li>• <b>PDM module removed</b></li> </ul>	<ul style="list-style-type: none"> <li>• al. area</li> </ul>	Acquisition module has been removed.	<ul style="list-style-type: none"> <li>• Connect the module if you want to restart the measurements.</li> </ul>
<ul style="list-style-type: none"> <li>• <b>PSM/PRESTN module removed</b></li> </ul>	<ul style="list-style-type: none"> <li>• al. area</li> </ul>	Acquisition module has been removed.	<ul style="list-style-type: none"> <li>• Connect the module if you want to restart the measurements.</li> </ul>
<ul style="list-style-type: none"> <li>• <b>Power management failure</b></li> </ul>	<ul style="list-style-type: none"> <li>• al. area</li> </ul>	There is a problem with communication to the power management controller.	<ul style="list-style-type: none"> <li>• Wait and see if the message disappears.</li> <li>• If the problem persists, contact authorized service personnel.</li> </ul>
<ul style="list-style-type: none"> <li>• <b>Printer error</b></li> </ul>	<ul style="list-style-type: none"> <li>• al. area</li> </ul>	Printer: A printer is not present or the printer needs paper.	<ul style="list-style-type: none"> <li>• Select <b>Monitor Setup &gt; Printing</b> to choose a different printer.</li> <li>• Add paper to the printer.</li> </ul>
<ul style="list-style-type: none"> <li>• <b>Printing Alarm</b></li> </ul>	<ul style="list-style-type: none"> <li>• al. area</li> </ul>	Recorder: An alarm has triggered printing.	<ul style="list-style-type: none"> <li>• Wait for the printing to finish.</li> </ul>
<ul style="list-style-type: none"> <li>• <b>Printing ready</b></li> </ul>	<ul style="list-style-type: none"> <li>• al. area</li> </ul>	Your printing request has been forwarded to the printer.	<ul style="list-style-type: none"> <li>• No action required.</li> </ul>

Message	Location	Explanation	What to do
<ul style="list-style-type: none"> <li>• <b>Printing...</b></li> </ul>	<ul style="list-style-type: none"> <li>• al. area</li> </ul>	Printer: Printing is occurring. Recorder: Manual printing is initiated for <b>Print Waveforms</b> , <b>ALL ECG</b> , <b>PA Waveform</b> , or <b>Catheter Insertion</b> .	<ul style="list-style-type: none"> <li>• Wait for the printing to finish.</li> </ul>
<ul style="list-style-type: none"> <li>• <b>Recorder cover open</b></li> </ul>	<ul style="list-style-type: none"> <li>• al. area</li> </ul>	The recorder cover is open.	<ul style="list-style-type: none"> <li>• Close the recorder cover.</li> </ul>
<ul style="list-style-type: none"> <li>• <b>Recorder input voltage high / Recorder input voltage low</b></li> </ul>	<ul style="list-style-type: none"> <li>• al. area</li> </ul>	There are problems with the recorder input voltage.	<ul style="list-style-type: none"> <li>• Contact authorized service personnel.</li> </ul>
<ul style="list-style-type: none"> <li>• <b>Recorder out of paper</b></li> </ul>	<ul style="list-style-type: none"> <li>• al. area</li> </ul>	The recorder is out of paper or the recorder cover is open.	<ul style="list-style-type: none"> <li>• Replace recorder paper.</li> <li>• Close the recorder cover.</li> </ul>
<ul style="list-style-type: none"> <li>• <b>Recorder system error</b></li> </ul>	<ul style="list-style-type: none"> <li>• al. area</li> </ul>	The local recorder is not working.	<ul style="list-style-type: none"> <li>• Reset the local recorder by turning the monitor's power off and on again. If this does not help, contact authorized service personnel.</li> </ul>
<ul style="list-style-type: none"> <li>• <b>Recorder thermal array overheat</b></li> </ul>	<ul style="list-style-type: none"> <li>• al. area</li> </ul>	There are problems with the recorder temperature.	<ul style="list-style-type: none"> <li>• Try stopping the recording as it may help.</li> <li>• If the problem persists, contact authorized service personnel.</li> </ul>
<ul style="list-style-type: none"> <li>• <b>Replace battery A</b></li> <li>• <b>Replace battery B</b></li> </ul>	<ul style="list-style-type: none"> <li>• al. area</li> </ul>	Battery A or B is not working properly.	<ul style="list-style-type: none"> <li>• Replace the battery.</li> </ul>
<ul style="list-style-type: none"> <li>• <b>Replace monitor battery</b></li> </ul>	<ul style="list-style-type: none"> <li>• al. area</li> </ul>	Monitor battery is not working properly.	<ul style="list-style-type: none"> <li>• Replace the battery.</li> </ul>
<ul style="list-style-type: none"> <li>• <b>Saving</b></li> </ul>	<ul style="list-style-type: none"> <li>• al. area</li> </ul>	The recorder is unavailable while printing manual or alarm waveform recording, and the recording is saved for later printing.  No recording location has been selected.	<ul style="list-style-type: none"> <li>• Check the recorder.</li> <li>• Select a recording location.</li> </ul>
<ul style="list-style-type: none"> <li>• <b>Saving to network</b></li> </ul>	<ul style="list-style-type: none"> <li>• al. area</li> </ul>	Connection to the S/5 Network was established and the monitor is saving patient data collected while disconnected from the network.	<ul style="list-style-type: none"> <li>• No action required.</li> </ul>
<ul style="list-style-type: none"> <li>• <b>Service Monitor - and specific error indication</b></li> </ul>	<ul style="list-style-type: none"> <li>• al. area</li> </ul>	Technical fault in the monitor.	<ul style="list-style-type: none"> <li>• Contact authorized service personnel.</li> </ul>
<ul style="list-style-type: none"> <li>• <b>Service the PDM — and specific error indication</b></li> </ul>	<ul style="list-style-type: none"> <li>• al. area</li> </ul>	Technical fault in the PDM.	<ul style="list-style-type: none"> <li>• Contact authorized service personnel.</li> </ul>
<ul style="list-style-type: none"> <li>• <b>Setting activation after next case end</b></li> </ul>	<ul style="list-style-type: none"> <li>• al. area</li> </ul>	There is a pending setting activation that will take place after you end the case.	<ul style="list-style-type: none"> <li>• If necessary, cancel the activation.</li> </ul>

Messages

Message	Location	Explanation	What to do
<ul style="list-style-type: none"> <li>• <b><i>Setting activation after next discharge</i></b></li> </ul>	<ul style="list-style-type: none"> <li>• al. area</li> </ul>	There is a pending setting activation that will take place after you discharge the patient.	<ul style="list-style-type: none"> <li>• If necessary, cancel the activation.</li> </ul>
<ul style="list-style-type: none"> <li>• <b><i>Software activation after next case end</i></b></li> </ul>	<ul style="list-style-type: none"> <li>• al. area</li> </ul>	There is a pending software activation that will take place after you end the case.	<ul style="list-style-type: none"> <li>• If necessary, cancel the activation.</li> </ul>
<ul style="list-style-type: none"> <li>• <b><i>Software activation after next discharge</i></b></li> </ul>	<ul style="list-style-type: none"> <li>• al. area</li> </ul>	There is a pending software activation that will take place after you discharge the patient.	<ul style="list-style-type: none"> <li>• If necessary, cancel the activation.</li> </ul>
<ul style="list-style-type: none"> <li>• <b><i>Speaker failure</i></b></li> </ul>	<ul style="list-style-type: none"> <li>• al. area</li> </ul>	The speaker is not working as it should.	<ul style="list-style-type: none"> <li>• Contact authorized service personnel.</li> </ul>
<ul style="list-style-type: none"> <li>• <b><i>Tram module removed</i></b></li> </ul>	<ul style="list-style-type: none"> <li>• al. area</li> </ul>	Acquisition module has been removed.	<ul style="list-style-type: none"> <li>• Connect the module if you want to restart the measurements.</li> </ul>
<ul style="list-style-type: none"> <li>• <b><i>Unable to read licenses</i></b></li> </ul>	<ul style="list-style-type: none"> <li>• al. area</li> </ul>	The system cannot use the correct license file.	<ul style="list-style-type: none"> <li>• Contact authorized service personnel.</li> </ul>



# Abbreviations

## List of abbreviations

The abbreviations that appear in the monitor software are indicated with bold and italic typeface. Other abbreviations listed in this table appear in the monitor manuals. Some abbreviations listed have multiple meanings but are differentiated by the context in which they appear.

<i>/min</i>	beats per minute, breaths per minute
°C	Celsius degree
°F	Fahrenheit degree
μ	micro
<b>% PCV</b>	percent of packed cell volume
12RL	twelve reduced leads
12SL	twelve simultaneous leads
a	arterial
A	auricular
<b>A Fib</b>	atrial fibrillation
A	alveolar
<b>a/AO₂</b>	arterio-alveolar PO ₂ ratio
<b>AA</b>	anesthetic agent
<b>AaDO₂</b>	alveoli-arterial oxygen difference
AAMI	Association for the Advancement of Medical Instrumentation
AC	alternating current
<b>A/C</b>	assist control
<b>Accel. Ventric.</b>	accelerated ventricular rhythm
<b>ACI - TIPI</b>	acute cardiac ischemia - time insensitive predictive instrument
ACL	access control list
<b>ACS</b>	acute coronary syndrome
<b>ACT</b>	activated clotting time
<b>A/C TCPL</b>	assist control time-cycle pressure-limited
<b>AEP</b>	auditory evoked potential

## Abbreviations

AGSS	anesthetic gas scavenging system
AHA	American Heart Association
<b>AirW</b>	airway temperature
Alpha	alpha frequency band
<b>Alpha%</b>	alpha frequency band percentage
<b>Amp</b>	amplitude
ANATEL	Agência Nacional de Telecomunicações
ANSI	American National Standards Institute
Ant.	anterior
<b>APN</b>	apnea
Arrh	arrhythmia
<b>Art; ABP</b>	arterial pressure
ASA	American Society of Anesthesiologists
<b>ASB</b>	assisted spontaneous breathing
ASY	asystole
<b>ATMP</b>	atmospheric pressure
<b>ATPD</b>	atmospheric/ambient temperature and pressure, dry gas
ATPS	ambient temperature and pressure, saturated gas
<b>Auto</b>	continuous NIBP measurement mode
<b>aVF</b>	left foot augmented lead
avg	average
<b>aVL</b>	left arm augmented lead
AVOA	automatic view on alarm
<b>aVR</b>	right arm augmented lead
<b>Axil</b>	axillary temperature
BAEP	brainstem auditory evoked potential
<b>BE</b>	base excess
Beta	beta frequency band
<b>Be%</b>	beta frequency band percentage
<b>BIPAP</b>	biphasic positive airway pressure
<b>BIS</b>	bispectral index
BISx	digital signal processing unit
<b>Blad</b>	bladder temperature
<b>BNP</b>	B-type natriuretic peptide
bpm	beats per minute
<b>Brady</b>	bradycardia
<b>BSA</b>	body surface area

<b>BSR</b>	burst suppression ratio
<b>B-to-B</b>	beat-to-beat
<b>BTSP</b>	body temperature and pressure, saturated gas
<b>BUN</b>	blood urea nitrogen
C	central
C (C1 - C6)	chest
C(a-v)O ₂	arteriovenous oxygen content difference
<b>C.I.</b>	cardiac index
<b>C.O.</b>	cardiac output
C1 to C6	ECG lead C1 to ECG lead C6
cal.	calibration
Calcs	calculations
<b>CaO₂</b>	arterial oxygen content
cc	cubic centimeter
<b>CCI</b>	continuous cardiac index
<b>CCO</b>	continuous cardiac output
<b>CcO₂</b>	capillary oxygen content
<b>CCU</b>	cardiac (coronary) care unit
CIC	Clinical Information Center
<b>Cl_{calc}</b>	cardiac index calculated by Fick equation
CICU	cardiac intensive care unit
CISPR	International Special Committee on Radio Interference
<b>CK-MB</b>	cardiac muscle type creatine kinase
<b>Cl</b>	chlorine
<b>cmH₂O</b>	centimeter of water
CMRR	common mode rejection ratio
CNS	central nervous system
<b>CO₂</b>	carbon dioxide
<b>CO_{calc}</b>	cardiac output calculated by Fick equation
COHb	carboxyhemoglobin
<b>Compl; C</b>	compliance
Complstat	static compliance
<b>Contin Flow</b>	continuous flow
<b>Contrl; Controlled</b>	controlled ventilation
<b>Core</b>	core temperature
<b>Count</b>	count of responses
<b>CPAP</b>	continuous positive airway pressure

## Abbreviations

<b>CPAP Contin</b>	continuous positive airway pressure continuous
<b>CPAP Demand</b>	continuous positive airway pressure on demand
<b>CPAP/ASB</b>	continuous positive airway pressure & assisted spontaneous breathing
<b>CPAP/IMV TCPL</b>	continuous positive airway pressure & control time-cycle pressure-limited
<b>CPAP/PPS</b>	continuous positive airway pressure & proportional pressure support
CPB	cardiopulmonary bypass
<b>CPP</b>	cerebral perfusion pressure
<b>CPPV</b>	continuous positive pressure ventilation
<b>CPPV/Assist</b>	continuous positive pressure ventilation & assisted
CPU	central processing unit
Cr	creatinine
CSA	Canadian Standards Association
<b>CSA</b>	compressed spectral array
CT	computed tomography
<b>CvO2</b>	venous oxygen content
<b>CVP</b>	central venous pressure
d	day
<b>dB</b>	decibel
<b>DBS</b>	double burst stimulation
DC	direct current
Delta	delta frequency band
<b>Delta%</b>	delta frequency band percentage
<b>Des</b>	desflurane
Diagn.	diagnostic
<b>Dia; DIA</b>	diastolic pressure
DIDCA	Device IDentification Cable Adapter
DIFF	difference
<b>DO2</b>	oxygen delivery
<b>DO2I</b>	oxygen delivery index
<b>DS</b>	dead space ventilation
DSC	digital signal converter
e	estimated
<b>ECG</b>	electrocardiogram
<b>ED</b>	emergency department
<b>EDV</b>	end-diastolic volume
<b>EDVI</b>	end-diastolic volume index
<b>EE</b>	energy expenditure (kcal/24h)

<b>EEG</b>	electroencephalogram
EEMG	evoked electromyogram
EEPROM	electrically erasable programmable read only memory
EEtot	total energy expenditure
EMBC	Ethernet module bus converter
EMC	electromagnetic compatibility
<b>EMG</b>	electromyogram
EMI	electromagnetic interference
<b>EMMV</b>	extended mandatory minute ventilation
<b>Enf</b>	enflurane
Entr.	Entropy
EP	evoked potential
ESD	electrostatic discharge
ESD	electrostatic sensitive devices
<b>Eso</b>	esophageal temperature
ESU	electrosurgical unit
<b>ESV</b>	end-systolic volume
<b>EDVI</b>	end-systolic volume index
<b>ET</b>	endotracheal
<b>ET; Et</b>	end-tidal concentration
EtAA	end-tidal anesthetic agent
EtBal	end-tidal balance gas
<b>EtCO2</b>	end-tidal carbon dioxide
EtN2O	end-tidal nitrous oxide
EtO2	end-tidal oxygen
<b>Exp; exp</b>	expiratory
f	frequency
F	foot (describing location)
F	frontal
F(I-E)O ₂	inspiratory mixed expiratory oxygen fraction difference
FECO ₂	mixed expired carbon dioxide concentration
<b>Fem</b>	femoral
<b>FEMG</b>	frontal electromyogram
<b>FemV</b>	femoral venous
FEO ₂	mixed expired oxygen concentration
FFT	fast Fourier transform
<b>Fi; Fi</b>	fraction of inspired gas

## Abbreviations

FiAA	fraction of inspired anesthetic agent
Fib	fibrillation
<b>FiCO2</b>	fraction of inspired carbon dioxide
FiN ₂	fraction of inspired nitrogen
<b>FiN2O</b>	fraction of inspired nitrous oxide
<b>FiO2</b>	fraction of inspired oxygen
<b>Flow</b> ; F	flow
<b>Flow-Vol Loop</b>	flow volume loop
Fp	fronto-polar
Fr	French (unit of measure for a Catheter diameter scale)
ft	feet
ft	foot
g	gram
<b>g/dl</b>	grams per deciliter
<b>g/l</b>	grams per liter
<b>GEDI</b>	global end-diastolic volume index
GND	ground
Graph.	graphical
<b>h</b>	hour
<b>Hal</b>	halothane
<b>Hb</b>	hemoglobin
HbO ₂	oxyhemoglobin
<b>HCO3-</b>	bicarbonate
<b>Hct</b>	hematocrit
HDU	high dependency unit
<b>Hemo</b>	hemodynamic
Hemo Calcs	hemodynamic calculations
<b>HFV</b>	high frequency ventilation
HIS	hospital information system
HME	heat and moisture exchanger
HMEF	heat and moisture exchanger with filter
<b>hPa</b>	hectopascal
<b>HR</b>	heart rate
<b>HRdif</b>	heart rate difference
HW	hardware
<b>Hz</b>	hertz
<b>I</b>	lead I

<b>I.U.</b>	international unit
<b>I:E</b>	inspiratory-expiratory ratio
<b>IABP</b>	intra-aortic balloon pump
<b>iCa</b>	ionized Calcium
ICASA	Independent Communications Authority of South Africa
<b>ICP</b>	intracranial pressure
<b>ICU</b>	intensive care unit
ID	identification
<b>IEC</b>	International Electrotechnical Commission
<b>II</b>	lead II
<b>III</b>	lead III
IM	intramuscular
<b>Imped</b>	impedance
ImpResp	impedance respiration
<b>IMV</b>	intermittent mandatory ventilation
<b>IMV Contin</b>	continuous intermittent mandatory ventilation
<b>IMV Demand</b>	intermittent mandatory ventilation on demand
<b>in</b>	inch
<b>IND</b>	induction
Inf.	inferior
Infl.	inflation (limit)
<b>INR</b>	international normalized ratio
<b>Insp; insp</b>	inspiratory
Insp Pause	inspiratory pause time
<b>IntelliRate</b>	automatic heart rate source selection of PDM
IP	internet protocol
<b>IP</b>	invasive blood pressure
<b>IPPV</b>	intermittent positive pressure ventilation
<b>IPPV/ASSIST</b>	intermittent positive pressure ventilation & assisted
IrMod%	infrared modulation percentage
<b>Iso</b>	isoflurane
ISO	International Standards Organization
<b>IV</b>	intravenous
IVR	idioventricular rhythm
J	joule
<b>K</b>	potassium
kbps	kilobits per second

## Abbreviations

<b>kcal</b>	kilocalorie
KCC	Korea Communications Commission
<b>kg</b>	kilogram
<b>kJ</b>	kilojoule
<b>kPa</b>	kilopascal
l	liter
<b>l/min</b>	liters/minute
LA	left arm (describing location)
<b>Lab</b>	laboratory
LAN	local area network
<b>LAP</b>	left atrial pressure
Lat.	lateral
<b>lb</b>	pound
LCD	liquid crystal display
<b>LCW</b>	left cardiac work
<b>LCWI</b>	left cardiac work index
LED	light emitting diode
LL	left leg (describing location)
LVEDP	left ventricular end diastolic pressure
LVEDV	left ventricular end diastolic volume
<b>LVSW</b>	left ventricular stroke work
<b>LCWI</b>	left ventricular stroke work index
<b>MAC</b>	minimum alveolar concentration
<b>MACage</b>	MAC compensated with patient age, patient temperature, and atmospheric pressure
<b>Man</b>	manual
<b>Man/Spont</b>	manual/spontaneous
MAP	mean arterial pressure
Max.	maximum
MB	megabyte
<b>mbar</b>	millibar
MBC	module bus controller
<b>mcg/l</b>	microgram per liter
<b>mcmol/l</b>	micromole per liter
<b>Mean; M</b>	mean blood pressure
<b>mEq</b>	milliequivalent
<b>mEq/l</b>	milliequivalent per liter



MetHb	methemoglobin
<b>MF</b>	median frequency
<b>mg</b>	milligram
<b>mg/dl</b>	milligram per deciliter
<b>ml.U.</b>	milli International Unit
MICU	medical intensive care unit
<b>min</b>	minute
Min	minimum
<b>ml</b>	milliliter
MLAEP	middle-latency auditory evoked potential
<b>mm</b>	millimeter
<b>mmHg</b>	millimeters of mercury
<b>mmol</b>	millimol
<b>mmol/l</b>	millimole per liter
<b>MMV</b>	mandatory minute ventilation
<b>MMV/ASB</b>	mandatory minute ventilation & assisted spontaneous breathing
Moder.	moderate
mol	mole
Monit.	monitoring
<b>MRI</b>	magnetic resonance imaging
MRN	medical record number
<b>ms</b>	millisecond
Multif. PVCs	multifocal premature ventricular contractions
<b>MV</b>	minute volume
<b>MVexp</b>	expired minute volume (l/min)
<b>MVexp (BTPS)</b>	expired minute volume in BTPS conditions
<b>MVexp (STPD)</b>	expired minute volume in STPD conditions
<b>MVinsp</b>	inspired minute volume (l/min)
<b>MVspont</b>	spontaneous minute volume
<b>Myo</b>	myocardial temperature
N	neutral
<b>N/A</b>	not applicable
N ₂	nitrogen
<b>N2O</b>	nitrous oxide
<b>Na</b>	sodium
<b>Naso</b>	nasopharyngeal temperature
<b>Neo</b>	neonate

## Abbreviations

Net	network
<b>Neuro</b>	neurological
Neuro ICU	neurological intensive care unit
<b>ng/l</b>	nanogram per liter
<b>ng/ml</b>	nanogram per milliliter
<b>NIBP</b>	non-invasive blood pressure
NIC	network interface card
<b>NICU</b>	neonatal intensive care unit
NMBA	neuromuscular blocking agent
<b>NMT</b>	neuromuscular transmission
<b>NTPD</b>	normal temperature and pressure, dry gas
O	occipital
<b>O₂</b>	oxygen
<b>O₂ER</b>	oxygen extraction ratio
<b>OR</b>	operation room
Oxy Calcs	oxygenation calculations
<b>Oxy</b>	oxygenation
OxyCRG	oxycardiogram
P	parietal
P	partial pressure
P	pressure
<b>Pa</b>	Pascal
<b>PA</b>	pulmonary arterial pressure
PAC	premature atrial contraction
Paced	paced beats
<b>PaCO₂</b>	partial pressure of carbon dioxide in the arteries
<b>PACU</b>	post anesthesia care unit
PaO ₂	partial pressure of oxygen in the arteries
<b>PAO₂</b>	partial pressure of oxygen in the alveoli
<b>Paw</b>	airway pressure
<b>Paw-Vol Loop</b>	pressure volume loop
Pbaro	barometric pressure
PC	personal computer
<b>pCO₂; PCO₂</b>	carbon dioxide partial pressure
pcs	pieces
<b>PCV</b>	pressure controlled ventilation
<b>PCV-A/C</b>	pressure controlled ventilation & assisted control

<b>PCV-CMV</b>	pressure controlled ventilation – controlled mandatory ventilation
<b>PCV-CPAP</b>	pressure controlled ventilation & continuous positive airway pressure
<b>PCWP</b>	pulmonary capillary wedge pressure
<b>PCV-SIMV</b>	pressure controlled ventilation & synchronized intermittent mandatory ventilation
PDF	portable document format
<b>PDM</b>	patient data module
PE	polyethylene
<b>Pedi</b>	pediatric
<b>PEEP</b>	positive end-expiratory pressure
<b>PEEPe</b>	extrinsic positive end expiratory pressure (ICU, NICU, ED software packages)
PEEPstat	static extrinsic positive end expiratory pressure (ICU, ED software packages)
<b>PEEPe+PEEPi</b>	total positive end expiratory pressure (ICU, NICU, ED software packages)
<b>PEEPi</b>	intrinsic positive end expiratory pressure (ICU, NICU, ED software packages)
PEEPstat	static intrinsic positive end expiratory pressure (ICU, ED software packages)
<b>PEEPtot</b>	total positive end expiratory pressure (OR, PACU software packages)
<b>pg/ml</b>	picogram per milliliter
<b>pH</b>	potential of hydrogen
<b>pHa</b>	arterial pH
<b>pHv</b>	mixed venous pH
<b>pHv</b>	venous pH
PIC	patient interface cable
PICU	pediatric intensive care unit
<b>Pinsp</b>	inspiratory (target) pressure
Pir	perfusion index (relative)
<b>Pleth</b>	plethysmographic pulse waveform
<b>Pmean</b>	mean pressure
Pmin	minimum pressure
PN	part number
<b>pO₂; PO₂</b>	oxygen partial pressure
<b>Ppeak</b>	peak pressure
<b>Pplat</b>	plateau (pause) pressure
Pplatstat	static plateau pressure
<b>PPV</b>	pulse pressure variation
<b>PR</b>	pulse rate

## Abbreviations

PSM	patient side module
<b>PT</b>	prothrombin time
<b>PTC</b>	post tetanic count
PVC	polyvinyl chloride
<b>PVC</b>	premature ventricular contraction
<b>PvCO₂</b>	carbon dioxide partial pressure in mixed venous blood
<b>PvO₂</b>	partial pressure of oxygen in (mixed) venous blood
<b>PVR</b>	pulmonary vascular resistance
<b>PVRI</b>	pulmonary vascular resistance index
QRS	QRS complex
<b>Qs/Qt</b>	venous admixture
<b>QT</b>	Q-T interval
<b>QTc</b>	corrected value of the QT interval
R	right (describing location)
<b>R on T</b>	early PVC, close to the T wave of the preceding normal beat
RA	right arm (describing location)
RAM	random access memory
<b>RAP</b>	right atrial pressure
<b>Raw</b>	airway resistance
<b>RCW</b>	right cardiac work
<b>RCWI</b>	right cardiac work index
<b>RE</b>	response Entropy
<b>Rect</b>	rectal temperature
ref	reference
<b>REF</b>	right ventricular ejection fraction
<b>Resp Rate</b>	respiration rate (total) (measured)
RF	radio frequency
RHb	reduced hemoglobin
RL	reduced leadset
RMS	average (root mean square) power
ROM	read only memory
<b>Room</b>	room temperature
<b>RQ</b>	respiratory quotient
<b>RR</b>	respiration rate
RV	residual volume
<b>RVEDV</b>	right ventricular end-diastolic volume
<b>RVEDVI</b>	right ventricular end-diastolic volume index

<b><i>RVESV</i></b>	right ventricular end-systolic volume
<b><i>RVESVI</i></b>	right ventricular end-systolic volume index
<b><i>RVP</i></b>	right ventricular pressure
<b><i>RVSW</i></b>	right ventricular stroke work
<b><i>RVSWI</i></b>	right ventricular stroke work index
<b><i>s</i></b>	second
<b><i>SaO2</i></b>	arterial oxygen saturation
<b><i>SB</i></b>	spontaneous breathing
<b><i>SDU</i></b>	step-down unit
<b><i>SE</i></b>	state Entropy
<b><i>SEF</i></b>	spectral edge frequency
<b><i>SEMG</i></b>	spontaneous electromyogram
<b><i>Sev</i></b>	sevoflurane
<b><i>SI</i></b>	stroke index
<b><i>SICU</i></b>	surgical intensive care unit
<b><i>SIMV</i></b>	synchronized intermittent mandatory ventilation
<b><i>SIMV/ASB</i></b>	synchronized intermittent mandatory ventilation & assisted spontaneous breathing
<b><i>SIMV/CPAP</i></b>	synchronized intermittent mandatory ventilation & continuous positive airway pressure
<b><i>SIMVPS</i></b>	synchronized intermittent mandatory ventilation & pressure support
<b><i>SjO₂</i></b>	jugular bulb oxygen saturation
<b><i>Skin</i></b>	skin temperature
<b><i>SL</i></b>	simultaneous leads
<b><i>SN</i></b>	serial number
<b><i>SO₂</i></b>	saturated oxygen
<b><i>Spiro</i></b>	Patient Spirometry
<b><i>SpO₂</i></b>	oxygen saturation
<b><i>Spont</i></b>	spontaneous
<b><i>SPS</i></b>	samples per second
<b><i>SPV</i></b>	systolic pressure variation
<b><i>SQ</i></b>	subcutaneous
<b><i>SQI</i></b>	signal quality index
<b><i>SR</i></b>	suppression ratio
<b><i>SRAM</i></b>	static random access memory
<b><i>SSEP</i></b>	somatosensory evoked potentials
<b><i>ST</i></b>	single twitch
<b><i>ST</i></b>	ST segment

## Abbreviations

<b>Stat</b>	five minute continuous NIBP measurement mode
<b>STPD</b>	standard temperature and pressure, dry gas
<b>Supra</b>	supramaximal
<b>Surf</b>	surface temperature
<b>SV</b>	stroke volume
SV	supraventricular
SW	software
<b>SVC</b>	supra ventricular contraction
<b>SVI</b>	stroke volume index
<b>SvO2</b>	mixed venous oxygen saturation
<b>SVR</b>	systemic vascular resistance
<b>SVRI</b>	systemic vascular resistance index
<b>SV Tachy</b>	supra ventricular tachycardia
<b>SVV</b>	stroke volume variation
<b>Sync MAS</b>	Synchrom Master
<b>Sync SLV</b>	Synchrom Slave
<b>Sys; SYS</b>	systolic pressure
<b>T</b>	temperature
T	temporal
<b>T(BTPS)</b>	temperature in BTPS conditions
<b>T1</b>	first twitch
<b>T1%</b>	first stimulus as percent of the reference value NMT
Tab	tabular
<b>Tachy</b>	tachycardia
<b>Tblood</b>	blood temperature
<b>TC</b>	transcutaneous
<b>TcCO2</b>	transcutaneous carbon dioxide
<b>TcO2</b>	transcutaneous oxygen
<b>TCO2</b>	total carbon dioxide
Tcorr	patient temperature used to correct pH, PCO ₂ , PO ₂
TCP/IP	transmission control protocol / internet protocol
<b>Temp</b>	temperature
Texp	expiratory time
Theta	theta frequency band
<b>Theta%</b>	theta frequency band percentage
Tinj	injectate temperature
<b>Tinsp</b>	inspiratory time

<b>TOF</b>	train of four
<b>TOF%</b>	train of four percentage
Torr	Torr (unit of pressure)
<b>Tpause</b>	pause time
TTX	telemetry transmitter
<b>TV</b>	tidal volume
<b>TVexp</b>	expired tidal volume (ml)
<b>TVinsp</b>	inspired tidal volume (ml)
Tx-Ty	temperature difference
<b>Tymp</b>	tympanic temperature
<b>UAC</b>	umbilical arterial catheter
UCD	user centered design
UI	user interface
<b>UVC</b>	umbilical venous catheter
V	ventricular
V; <b>Vent</b>	ventilation
<b>V (V1-V6)</b>	chest
<b>V Brady</b>	ventricular bradycardia
V Fib	ventricular fibrillation
<b>V Tach</b>	ventricular tachycardia
v	venous
<b>(V1 to (V1-V6)</b>	ECG lead <b>V1</b> to ECG lead <b>(V1-V6)</b>
<b>VA</b>	alveolar ventilation
VC	vital capacity
<b>VCO2</b>	carbon dioxide production
<b>Vd</b>	dead space
<b>Vd/Vt</b>	dead space ventilation
<b>Vent</b>	ventilator
Vent Calcs	ventilation calculations
WLAN	wireless local area network
<b>VO2</b>	oxygen consumption
<b>VO2calc</b>	calculated oxygen consumption
<b>VO2Icalc</b>	calculated oxygen consumption index
<b>VO2</b>	oxygen consumption index
<b>Vol; V</b>	volume
<b>Vol Assist</b>	volume assisted
<b>VT &gt; 2</b>	ventricular tachycardia with more than two beats

## Abbreviations

yr	year
<i>yrs</i>	years





# Skills checklist

## System introduction

To familiarize yourself with these functions and features, study the topics listed as the recommended reading of this User's Manual. The numbers in brackets refer to the page numbers in the manual. As you proceed, mark your completed tasks in the table.

Recommended reading	Completed	Not applicable
SYSTEM SAFETY PRECAUTIONS <ul style="list-style-type: none"><li>• <a href="#">System warnings (53)</a></li></ul>		
<ul style="list-style-type: none"><li>• <a href="#">System caution (54)</a></li></ul>		
B850 SYSTEM COMPONENTS <ul style="list-style-type: none"><li>• <a href="#">B850 system components (55)</a></li></ul>		
B650 SYSTEM COMPONENTS <ul style="list-style-type: none"><li>• <a href="#">B650 system components (58)</a></li></ul>		
MONITOR BATTERY <ul style="list-style-type: none"><li>• <a href="#">Monitor battery (62)</a></li></ul>		
ALARM LIGHT <ul style="list-style-type: none"><li>• <a href="#">Alarm light (65)</a></li></ul>		
DISPLAYS <ul style="list-style-type: none"><li>• <a href="#">Displays (65)</a></li></ul>		
ACQUISITION MODULES <ul style="list-style-type: none"><li>• <a href="#">Acquisition modules (66)</a></li></ul>		
EQUIPMENT SYMBOLS <ul style="list-style-type: none"><li>• <a href="#">Equipment symbols (77)</a></li></ul>		
USER INTERFACE SYMBOLS <ul style="list-style-type: none"><li>• <a href="#">User interface symbols (84)</a></li></ul>		

## Starting and ending

To familiarize yourself with these functions and features, study the topics listed as the recommended reading of this User's Manual. The numbers in brackets refer to the page numbers in the manual. As you proceed, mark your completed tasks in the table.

## Skills checklist

Recommended reading	Completed	Not applicable
<b>CASE START / PATIENT ADMISSION</b> <ul style="list-style-type: none"> <li>Starting monitoring (112)</li> </ul>		
<b>ROVING BEDS AND UNITS</b> <ul style="list-style-type: none"> <li>About the roving functionality (115)</li> </ul>		
<ul style="list-style-type: none"> <li>Roving between units (116)</li> </ul>		
<ul style="list-style-type: none"> <li>Roving between beds (116)</li> </ul>		
<ul style="list-style-type: none"> <li>Adding new units and beds (manual roving) (116)</li> </ul>		
<b>LOADING PATIENT INFORMATION</b> <ul style="list-style-type: none"> <li>Loading patient information from the CARESCAPE Network (ADT server) (117)</li> </ul>		
<ul style="list-style-type: none"> <li>Loading patient data and trend data from the S/5 Network (117)</li> </ul>		
<b>USING STANDBY</b> <ul style="list-style-type: none"> <li>Starting standby (118)</li> </ul>		
<ul style="list-style-type: none"> <li>End of standby (119)</li> </ul>		
<b>CONTINUING MONITORING</b> <ul style="list-style-type: none"> <li>How to continue monitoring when a case is not active/patient is discharged (119)</li> </ul>		
<ul style="list-style-type: none"> <li>How to continue monitoring when a case is active/patient is admitted (120)</li> </ul>		
<b>CASE RESET / PATIENT DISCHARGE</b> <ul style="list-style-type: none"> <li>Resetting a case/discharging a patient (121)</li> </ul>		
<ul style="list-style-type: none"> <li>Resetting a case/discharging a patient in combination monitoring mode (122)</li> </ul>		

## Monitoring basics

To familiarize yourself with these functions and features, study the topics listed as the recommended reading of this User's Manual. The numbers in brackets refer to the page numbers in the manual. As you proceed, mark your completed tasks in the table.

Recommended reading	Completed	Not applicable
<b>MAIN KEYS</b> <ul style="list-style-type: none"> <li>Main keys (93)</li> </ul>		
<b>MAIN SCREEN LAYOUT</b> <ul style="list-style-type: none"> <li>Main screen layout (95)</li> </ul>		
<b>OPERATION SAFETY PRECAUTIONS</b> <ul style="list-style-type: none"> <li>Operation warnings (98)</li> </ul>		
<ul style="list-style-type: none"> <li>Operation caution (99)</li> </ul>		
<b>MONITOR INSTALLATION POINTS TO NOTE</b> <ul style="list-style-type: none"> <li>Monitor installation points to note (99)</li> </ul>		

Recommended reading	Completed	Not applicable
TURNING ON THE MONITOR <ul style="list-style-type: none"> <li>Turning on the monitor (99)</li> </ul>		
PRE-MONITORING CHECKLIST <ul style="list-style-type: none"> <li>Pre-monitoring checklist (100)</li> </ul>		

## Alarms

To familiarize yourself with these functions and features, study the topics listed as the recommended reading of this User's Manual. The numbers in brackets refer to the page numbers in the manual. As you proceed, mark your completed tasks in the table.

Recommended reading	Completed	Not applicable
SAFETY PRECAUTIONS <ul style="list-style-type: none"> <li>Alarm warnings (123)</li> <li>Alarm cautions (125)</li> </ul>		
OVERVIEW <ul style="list-style-type: none"> <li>Alarm types (125)</li> <li>Alarm conditions (125)</li> <li>Alarm priority levels (126)</li> <li>Selecting parameter alarm priority levels (137)</li> <li>Alarm priority escalation (126)</li> <li>Physiological alarms' activation criteria (126)</li> </ul>		
CHECKING THE FUNCTION <ul style="list-style-type: none"> <li>Checking alarm function (129)</li> </ul>		
ALARM INDICATIONS <ul style="list-style-type: none"> <li>Alarm icons on the screen (129)</li> <li>Setting the alarm light brightness (130)</li> <li>Adjusting the alarm volume (131)</li> <li>Audible and visual alarm signals (131)</li> <li>Turning off all local alarm indicators (sleep mode) (139)</li> <li>Physiological alarms' activation criteria (126)</li> </ul>		
ALARM DEACTIVATION <ul style="list-style-type: none"> <li>Technical alarms' deactivation with the pause audio key (134)</li> </ul>		
PAUSE AUDIO IN COMBINATION MONITORING (TELEMETRY) <ul style="list-style-type: none"> <li>Pause audio with combination monitoring (135)</li> </ul>		
BREAKTHROUGH AND LATCHED ALARMS <ul style="list-style-type: none"> <li>Breakthrough alarms (135)</li> <li>Latched alarms (135)</li> </ul>		

## Trends

To familiarize yourself with these functions and features, study the topics listed as the recommended reading of this User's Manual. The numbers in brackets refer to the page numbers in the manual. As you proceed, mark your completed tasks in the table.

Recommended reading	Completed	Not applicable
TREND VIEWS <ul style="list-style-type: none"> <li>Trend views (407)</li> </ul>		
GRAPHIC TRENDS <ul style="list-style-type: none"> <li>Viewing graphic trends (407)</li> <li>Changing the time scale of graphic trends (408)</li> <li>Changing the graphic trend scales (409)</li> <li>Graphic trend resolution and the high-resolution license (409)</li> </ul>		
NUMERIC TRENDS <ul style="list-style-type: none"> <li>Viewing numeric trends (410)</li> <li>Changing the time interval of numeric trends (410)</li> </ul>		
IP TRENDS <ul style="list-style-type: none"> <li>Invasive pressure trends (410)</li> </ul>		
HR TRENDS <ul style="list-style-type: none"> <li>Heart rate (HR) trends (411)</li> </ul>		
GAS CONSUMPTION <ul style="list-style-type: none"> <li>Viewing gas consumption data (411)</li> <li>Printing gas consumption data (411)</li> </ul>		
MINITRENDS <ul style="list-style-type: none"> <li>Minitrend view (411)</li> <li>Selecting high-resolution contents to minitrend (413)</li> </ul>		

## Snapshots and events

To familiarize yourself with these functions and features, study the topics listed as the recommended reading of this User's Manual. The numbers in brackets refer to the page numbers in the manual. As you proceed, mark your completed tasks in the table.

Recommended reading	Completed	Not applicable
SNAPSHOTS <ul style="list-style-type: none"> <li>Description of snapshots (415)</li> <li>Manually created snapshots (415)</li> <li>Creating automatic snapshots (415)</li> <li>Viewing snapshots (416)</li> <li>Erasing snapshots and trends (417)</li> </ul>		

Recommended reading	Completed	Not applicable
EVENTS		
• Viewing events (420)		
• Creating events manually (420)		
• Deleting events (421)		

## ECG

To familiarize yourself with this parameter and its use with the CARESCAPE modular monitors, study the topics listed as the recommended reading of this User's Manual. The numbers in brackets refer to the page numbers in the manual. As you proceed, mark your completed tasks in the table.

Recommended reading	Completed	Not applicable
GENERAL MEASUREMENT OVERVIEW		
• ECG warnings (141)		
• ECG cautions (143)		
• ECG measurement limitations (143)		
• ECG points to note (143)		
• ECG equipment to patient connection (144)		
• Checking the ECG measurement (148)		
PREPARING THE PATIENT		
• Preparing the patient's electrode sites (144)		
• Applying the electrodes to the patient (144)		
• 3-lead or 5-lead ECG electrode placement (145)		
• 6-lead ECG electrode placement (145)		
• 10-lead ECG electrode placement for cardiac monitoring (146)		
• Standard resting 10-lead ECG electrode placement (147)		
SELECTING SOURCE		
• Selecting the ECG source (150)		
SELECTING LEADS		
• The first three displayed ECG leads (150)		
• Selecting the first displayed ECG lead (151)		
• Selecting the second displayed ECG lead (151)		
• Selecting the third displayed ECG lead (151)		
USING THE MEASUREMENT		
• Selecting the beat source (152)		
• Setting the beep tone during bradycardia and HR low alarms (153)		
• Aspect ratio and different display sizes (153)		

## Skills checklist

Recommended reading	Completed	Not applicable
<ul style="list-style-type: none"> <li>Selecting the ECG waveform size (154)</li> </ul>		
<ul style="list-style-type: none"> <li>Selecting the ECG waveform filter (154)</li> </ul>		
<ul style="list-style-type: none"> <li>Selecting the leads for ECG analysis (155)</li> </ul>		
<ul style="list-style-type: none"> <li>Relearning the patient's QRS pattern (156)</li> </ul>		
ECG ALARM LIMITS		
<ul style="list-style-type: none"> <li>ECG alarm limits (157)</li> </ul>		
12 LEAD ANALYSIS		
<ul style="list-style-type: none"> <li>Intended use of 12RL Interpolated 12 lead ECG analysis (160)</li> </ul>		
<ul style="list-style-type: none"> <li>Intended use of 12SL ECG analysis (161)</li> </ul>		
<ul style="list-style-type: none"> <li>Intended use of ACI-TIPI (161)</li> </ul>		
<ul style="list-style-type: none"> <li>12 lead ECG analysis points to note (161)</li> </ul>		
<ul style="list-style-type: none"> <li>Enabling and disabling the 12SL ACS (162)</li> </ul>		
PACEMAKER DETECTION		
<ul style="list-style-type: none"> <li>Pacemaker detection warnings (166)</li> </ul>		
<ul style="list-style-type: none"> <li>Selecting the pacemaker detection (167)</li> </ul>		
ARRHYTHMIA DETECTION		
<ul style="list-style-type: none"> <li>Arrhythmia monitoring warnings (169)</li> </ul>		
<ul style="list-style-type: none"> <li>Arrhythmia measurement limitations (170)</li> </ul>		
<ul style="list-style-type: none"> <li>Setting the arrhythmia category to alarm (171)</li> </ul>		
<ul style="list-style-type: none"> <li>Setting arrhythmia alarms (171)</li> </ul>		
<ul style="list-style-type: none"> <li>Arrhythmia alarm messages (172)</li> </ul>		
ST DETECTION		
<ul style="list-style-type: none"> <li>ST detection measurement limitations (177)</li> </ul>		
<ul style="list-style-type: none"> <li>Starting the ST detection (177)</li> </ul>		
QT DETECTION		
<ul style="list-style-type: none"> <li>QT/QTc measurement limitations (184)</li> </ul>		
<ul style="list-style-type: none"> <li>Starting the QT/QTc measurement (184)</li> </ul>		

## Impedance respiration

To familiarize yourself with this parameter and its use with the CARESCAPE modular monitors, study the topics listed as the recommended reading of this User's Manual. The numbers in brackets refer to the page numbers in the manual. As you proceed, mark your completed tasks in the table.

Recommended reading	Completed	Not applicable
GENERAL MEASUREMENT OVERVIEW		
<ul style="list-style-type: none"> <li>Respiration warnings (185)</li> </ul>		
<ul style="list-style-type: none"> <li>Respiration cautions (186)</li> </ul>		

Recommended reading	Completed	Not applicable
<ul style="list-style-type: none"> <li>Respiration measurement limitations (186)</li> </ul>		
<ul style="list-style-type: none"> <li>Respiration points to note (186)</li> </ul>		
<ul style="list-style-type: none"> <li>Respiration measurement checks (190)</li> </ul>		
<ul style="list-style-type: none"> <li>Respiration equipment to patient connection (187)</li> </ul>		
RESPIRATION LEADS		
<ul style="list-style-type: none"> <li>Respiration lead and breath detection (187)</li> </ul>		
<ul style="list-style-type: none"> <li>Respiration lead I electrode placement (188)</li> </ul>		
<ul style="list-style-type: none"> <li>Respiration lead II electrode placement (189)</li> </ul>		
<ul style="list-style-type: none"> <li>Respiration lead RL-LL electrode placement (189)</li> </ul>		
USING THE MEASUREMENT		
<ul style="list-style-type: none"> <li>Selecting the waveform sensitivity (191)</li> </ul>		
<ul style="list-style-type: none"> <li>Setting the respiration alarm limits (191)</li> </ul>		
<ul style="list-style-type: none"> <li>Turning on or off the respiration rate alarm (191)</li> </ul>		
<ul style="list-style-type: none"> <li>Setting the apnea alarm delay (192)</li> </ul>		
<ul style="list-style-type: none"> <li>Enabling the respiration cardiac artifact alarm (192)</li> </ul>		
<ul style="list-style-type: none"> <li>Respiration alarm priorities (192)</li> </ul>		

## Pulse oximetry (SpO₂)

To familiarize yourself with this parameter and its use with the CARESCAPE modular monitors, study the topics listed as the recommended reading of this User's Manual. The numbers in brackets refer to the page numbers in the manual. As you proceed, mark your completed tasks in the table.

Recommended reading	Completed	Not applicable
GENERAL MEASUREMENT OVERVIEW		
<ul style="list-style-type: none"> <li>SpO₂ warnings (195)</li> </ul>		
<ul style="list-style-type: none"> <li>SpO₂ cautions (198)</li> </ul>		
<ul style="list-style-type: none"> <li>SpO₂ measurement limitations (198)</li> </ul>		
<ul style="list-style-type: none"> <li>SpO₂ points to note (198)</li> </ul>		
<ul style="list-style-type: none"> <li>Checking the SpO₂ measurement (201)</li> </ul>		
<ul style="list-style-type: none"> <li>SpO₂ equipment to patient connection (201)</li> </ul>		
<ul style="list-style-type: none"> <li>Preparing the SpO₂ connection (201)</li> </ul>		
MEASUREMENT GUIDELINES		
<ul style="list-style-type: none"> <li>GE Ohmeda technology and sensor measurement guidelines (199)</li> </ul>		
<ul style="list-style-type: none"> <li>Masimo SET technology and sensor measurement guidelines (199)</li> </ul>		

## Skills checklist

Recommended reading	Completed	Not applicable
<ul style="list-style-type: none"> <li>Nellcor OxiMax technology and sensor measurement guidelines (200)</li> </ul>		
USING THE MEASUREMENT		
<ul style="list-style-type: none"> <li>Primary and secondary SpO₂ measurement sources (202)</li> </ul>		
<ul style="list-style-type: none"> <li>Selecting the SpO₂ as the primary heart rate source (203)</li> </ul>		
<ul style="list-style-type: none"> <li>Adjusting the SpO₂ pulse beep tone volume (203)</li> </ul>		
<ul style="list-style-type: none"> <li>Masimo SET data averaging and updating (204)</li> </ul>		
<ul style="list-style-type: none"> <li>Nellcor OxiMax data averaging and updating (205)</li> </ul>		
<ul style="list-style-type: none"> <li>Setting the SpO₂ alarms and alarm limits (207)</li> </ul>		
<ul style="list-style-type: none"> <li>Deactivating the <i>SpO₂ probe off</i> alarm (207)</li> </ul>		

## Non-invasive blood pressure

To familiarize yourself with this parameter and its use with the CARESCAPE modular monitors, study the topics listed as the recommended reading of this User's Manual. The numbers in brackets refer to the page numbers in the manual. As you proceed, mark your completed tasks in the table.

Recommended reading	Completed	Not applicable
GENERAL MEASUREMENT OVERVIEW		
<ul style="list-style-type: none"> <li>NIBP warnings (213)</li> </ul>		
<ul style="list-style-type: none"> <li>NIBP cautions (214)</li> </ul>		
<ul style="list-style-type: none"> <li>NIBP measurement limitations (215)</li> </ul>		
<ul style="list-style-type: none"> <li>NIBP points to note (215)</li> </ul>		
<ul style="list-style-type: none"> <li>Checking the NIBP measurement (216)</li> </ul>		
<ul style="list-style-type: none"> <li>NIBP equipment to patient connection (216)</li> </ul>		
CUFF APPLICATION		
<ul style="list-style-type: none"> <li>Preparing the NIBP patient connection (216)</li> </ul>		
<ul style="list-style-type: none"> <li>NIBP cuff selection and placement (220)</li> </ul>		
SINGLE NIBP MEASUREMENT		
<ul style="list-style-type: none"> <li>Starting or stopping a single NIBP measurement from the main menu (217)</li> </ul>		
<ul style="list-style-type: none"> <li>Starting or stopping a single NIBP measurement from the <i>NIBP Setup</i> menu (217)</li> </ul>		
<ul style="list-style-type: none"> <li>Starting or stopping a single NIBP measurement with the PSM module key (217)</li> </ul>		
AUTOMATIC NIBP MEASUREMENTS		
<ul style="list-style-type: none"> <li>Starting or stopping the <i>NIBP Auto</i> from the <i>NIBP Setup</i> menu (218)</li> </ul>		
<ul style="list-style-type: none"> <li>Starting or stopping the NIBP Auto from the monitor's main menu (219)</li> </ul>		



Recommended reading	Completed	Not applicable
<ul style="list-style-type: none"> <li>Starting or stopping the NIBP Auto with the PSM module key (219)</li> </ul>		
STAT MODE <ul style="list-style-type: none"> <li>Starting or stopping a Stat NIBP measurement (219)</li> </ul>		
VENOUS STASIS <ul style="list-style-type: none"> <li>Venous stasis (219)</li> </ul>		
<ul style="list-style-type: none"> <li>Starting or stopping the venous stasis (220)</li> </ul>		

## Invasive pressures

To familiarize yourself with this parameter and its use with the CARESCAPE modular monitors, study the topics listed as the recommended reading of this User's Manual. The numbers in brackets refer to the page numbers in the manual. As you proceed, mark your completed tasks in the table.

Recommended reading	Completed	Not applicable
GENERAL MEASUREMENT OVERVIEW <ul style="list-style-type: none"> <li>Invasive pressure warnings (229)</li> </ul>		
<ul style="list-style-type: none"> <li>Invasive pressure measurement limitations (229)</li> </ul>		
<ul style="list-style-type: none"> <li>Invasive pressure points to note (230)</li> </ul>		
<ul style="list-style-type: none"> <li>Checking the invasive pressure measurement (231)</li> </ul>		
<ul style="list-style-type: none"> <li>Invasive pressure equipment to patient connection (230)</li> </ul>		
ZEROING <ul style="list-style-type: none"> <li>Zeroing the invasive pressure transducers (234)</li> </ul>		
USING THE MEASUREMENT <ul style="list-style-type: none"> <li>Selecting an invasive pressure channel label (234)</li> </ul>		
<ul style="list-style-type: none"> <li>Selecting the size of the invasive pressure waveform (234)</li> </ul>		
<ul style="list-style-type: none"> <li>Optimizing the invasive pressure waveform scale (234)</li> </ul>		
SYSTOLIC PRESSURE VARIATION AND PULSE PRESSURE VARIATION <ul style="list-style-type: none"> <li>Systolic pressure variation and pulse pressure variation (239)</li> </ul>		
PULMONARY CAPILLARY WEDGE PRESSURE (PCWP) MEASUREMENT <ul style="list-style-type: none"> <li>Pulmonary capillary wedge pressure (PCWP) measurement (240)</li> </ul>		

## Temperature

To familiarize yourself with this parameter and its use with the CARESCAPE modular monitors, study the topics listed as the recommended reading of this User's Manual. The numbers in brackets refer to the page numbers in the manual. As you proceed, mark your completed tasks in the table.

## Skills checklist

Recommended reading	Completed	Not applicable
GENERAL MEASUREMENT OVERVIEW		
<ul style="list-style-type: none"> <li>Temperature warnings (249)</li> </ul>		
<ul style="list-style-type: none"> <li>Temperature measurement limitations (249)</li> </ul>		
<ul style="list-style-type: none"> <li>Temperature points to note (249)</li> </ul>		
<ul style="list-style-type: none"> <li>Checking the temperature measurement (251)</li> </ul>		
<ul style="list-style-type: none"> <li>Temperature equipment to patient connection (250)</li> </ul>		
TEMPERATURE MEASUREMENT START		
<ul style="list-style-type: none"> <li>Starting the temperature measurement (252)</li> </ul>		
TEMPERATURE SITE NAME CHANGES		
<ul style="list-style-type: none"> <li>Changing the temperature site label (252)</li> </ul>		

## Cardiac output

To familiarize yourself with this parameter and its use with the CARESCAPE modular monitors, study the topics listed as the recommended reading of this User's Manual. The numbers in brackets refer to the page numbers in the manual. As you proceed, mark your completed tasks in the table.

Recommended reading	Completed	Not applicable
GENERAL MEASUREMENT OVERVIEW		
<ul style="list-style-type: none"> <li>C.O. warnings (255)</li> </ul>		
<ul style="list-style-type: none"> <li>C.O./CCO cautions (255)</li> </ul>		
<ul style="list-style-type: none"> <li>C.O. measurement limitations (255)</li> </ul>		
<ul style="list-style-type: none"> <li>C.O. points to note (255)</li> </ul>		
<ul style="list-style-type: none"> <li>Checking the C.O. measurement (258)</li> </ul>		
<ul style="list-style-type: none"> <li>C.O. equipment to patient connection with a bath probe (257)</li> </ul>		
<ul style="list-style-type: none"> <li>C.O. equipment to patient connection with an in-line probe (256)</li> </ul>		
C.O. SETUP		
<ul style="list-style-type: none"> <li>Selecting a C.O. catheter from the list (261)</li> </ul>		
<ul style="list-style-type: none"> <li>Entering a user-defined C.O. catheter (261)</li> </ul>		
<ul style="list-style-type: none"> <li>Selecting the C.O. injectate probe type (261)</li> </ul>		
OBTAINING A C.O.		
<ul style="list-style-type: none"> <li>Taking an automatic C.O. measurement (258)</li> </ul>		
<ul style="list-style-type: none"> <li>Taking a manual C.O. measurement (259)</li> </ul>		
EDITING C.O. TRIALS		
<ul style="list-style-type: none"> <li>C.O. trial measurements (260)</li> </ul>		
<ul style="list-style-type: none"> <li>Editing the C.O. average (260)</li> </ul>		
HEMODYNAMIC CALCULATIONS		
<ul style="list-style-type: none"> <li>Editing calculations (262)</li> </ul>		

## Mixed venous oxygen saturation (SvO₂)

To familiarize yourself with this parameter and its use with the CARESCAPE modular monitors, study the topics listed as the recommended reading of this User's Manual. The numbers in brackets refer to the page numbers in the manual. As you proceed, mark your completed tasks in the table.

Recommended reading	Completed	Not applicable
GENERAL MEASUREMENT OVERVIEW		
<ul style="list-style-type: none"> <li>SvO₂ warnings (267)</li> </ul>		
<ul style="list-style-type: none"> <li>SvO₂ measurement limitations (267)</li> </ul>		
<ul style="list-style-type: none"> <li>SvO₂ points to note (268)</li> </ul>		
<ul style="list-style-type: none"> <li>Checking the SvO₂ measurement (268)</li> </ul>		
<ul style="list-style-type: none"> <li>SvO₂ equipment to patient connection (268)</li> </ul>		
SvO ₂ CALIBRATION		
<ul style="list-style-type: none"> <li>SvO₂ calibration in vitro (269)</li> </ul>		
<ul style="list-style-type: none"> <li>Calibrating a new SvO₂ catheter in vitro (269)</li> </ul>		
<ul style="list-style-type: none"> <li>Calibrating SvO₂ in vivo (270)</li> </ul>		
SvO ₂ SIGNAL QUALITY INDICATORS		
<ul style="list-style-type: none"> <li>SvO₂ measurement on screen (268)</li> </ul>		

## Airway gases

To familiarize yourself with this parameter and its use with the CARESCAPE modular monitors, study the topics listed as the recommended reading of this User's Manual. The numbers in brackets refer to the page numbers in the manual. As you proceed, mark your completed tasks in the table.

Recommended reading	Completed	Not applicable
GENERAL MEASUREMENT OVERVIEW		
<ul style="list-style-type: none"> <li>Airway gases warnings (273)</li> </ul>		
<ul style="list-style-type: none"> <li>Airway gases cautions (275)</li> </ul>		
<ul style="list-style-type: none"> <li>Airway gases measurement limitations (275)</li> </ul>		
<ul style="list-style-type: none"> <li>Airway gases points to note (275)</li> </ul>		
<ul style="list-style-type: none"> <li>E-miniC indications for use (280)</li> </ul>		
<ul style="list-style-type: none"> <li>Checking the airway gases measurement (281)</li> </ul>		
<ul style="list-style-type: none"> <li>Airway gases equipment to patient connections with CARESCAPE respiratory modules (276)</li> </ul>		
<ul style="list-style-type: none"> <li>Airway gases equipment to patient connections with compact airway modules, anesthesia setup (277)</li> </ul>		
<ul style="list-style-type: none"> <li>Airway gases equipment to patient connections with compact airway modules, critical care setup (277)</li> </ul>		
<ul style="list-style-type: none"> <li>Airway gases equipment to patient connections with E-miniC, critical care setup (278)</li> </ul>		

## Skills checklist

Recommended reading	Completed	Not applicable
<b>MEASUREMENT SETUP</b> <ul style="list-style-type: none"> <li>Airway gases measurement setup (278)</li> </ul>		
<b>USING THE MEASUREMENT</b> <ul style="list-style-type: none"> <li>Selecting what to show with EtCO₂ (285)</li> <li>Selecting the FiO₂ level (285)</li> <li>Selecting the agent scale (286)</li> </ul>		
<b>SCAVENGING</b> <ul style="list-style-type: none"> <li>Scavenging through the ventilator reservoir (287)</li> <li>Scavenging through the anesthesia gas scavenging system (287)</li> <li>Connecting directly to the scavenging system (287)</li> </ul>		
<b>CALIBRATION</b> <ul style="list-style-type: none"> <li>Calibrating airway gases (288)</li> </ul>		

## CO₂ with CAPNOSTAT Mainstream, CapnoFlex LF, and Dual CO₂ modules

To familiarize yourself with this parameter and its use with the CARESCAPE modular monitors, study the topics listed as the recommended reading of this User's Manual. The numbers in brackets refer to the page numbers in the manual. As you proceed, mark your completed tasks in the table.

Recommended reading	Completed	Not applicable
<b>GENERAL MEASUREMENT OVERVIEW</b> <ul style="list-style-type: none"> <li>CO₂ warnings (299)</li> <li>CO₂ cautions (301)</li> <li>CO₂ points to note (301)</li> </ul>		
<b>CAPNOSTAT MAINSTREAM</b> <ul style="list-style-type: none"> <li>Equipment connection with CAPNOSTAT Mainstream module (301)</li> <li>Preparing the setup for CAPNOSTAT Mainstream module (302)</li> <li>Calibrating the CAPNOSTAT Mainstream sensor (302)</li> <li>Calibrating the CAPNOSTAT Mainstream adapter (303)</li> </ul>		
<b>CAPNOFLEX LF</b> <ul style="list-style-type: none"> <li>Equipment connection with CapnoFlex LF module (303)</li> <li>Preparing the setup for CapnoFlex LF module (304)</li> <li>Calibrating the CapnoFlex LF adapter (304)</li> </ul>		
<b>DUAL CO₂</b> <ul style="list-style-type: none"> <li>Equipment connection with Dual CO₂ module (304)</li> </ul>		

Recommended reading	Completed	Not applicable
<ul style="list-style-type: none"> <li>Preparing the sidestream setup with Dual CO₂ module (305)</li> </ul>		
<ul style="list-style-type: none"> <li>Calibrating the Dual CO₂ sensor (306)</li> </ul>		
<ul style="list-style-type: none"> <li>Calibrating the Dual CO₂ adapter (306)</li> </ul>		
USING THE MEASUREMENT		
<ul style="list-style-type: none"> <li>Selecting CO₂ average (308)</li> </ul>		
<ul style="list-style-type: none"> <li>Selecting apnea alarm limit (309)</li> </ul>		
SCAVENGING		
<ul style="list-style-type: none"> <li>Preventing operating room pollution with CAPNOSTAT Mainstream, Dual CO₂, and CapnoFlex LF modules (309)</li> </ul>		
<ul style="list-style-type: none"> <li>Scavenging to scavenging systems (309)</li> </ul>		

## Patient Spirometry

To familiarize yourself with this parameter and its use with the CARESCAPE modular monitors, study the topics listed as the recommended reading of this User's Manual. The numbers in brackets refer to the page numbers in the manual. As you proceed, mark your completed tasks in the table.

Recommended reading	Completed	Not applicable
GENERAL MEASUREMENT OVERVIEW		
<ul style="list-style-type: none"> <li>Patient Spirometry warnings (315)</li> </ul>		
<ul style="list-style-type: none"> <li>Patient Spirometry cautions (315)</li> </ul>		
<ul style="list-style-type: none"> <li>Patient Spirometry limitations (315)</li> </ul>		
<ul style="list-style-type: none"> <li>Patient Spirometry points to note (316)</li> </ul>		
<ul style="list-style-type: none"> <li>Checking the Patient Spirometry measurement (317)</li> </ul>		
<ul style="list-style-type: none"> <li>Patient Spirometry equipment to patient connection (316)</li> </ul>		
USING THE MEASUREMENT		
<ul style="list-style-type: none"> <li>Preparing the Patient Spirometry measurement (317)</li> </ul>		
<ul style="list-style-type: none"> <li>Selecting the Patient Spirometry scales (318)</li> </ul>		
<ul style="list-style-type: none"> <li>Selecting the Patient Spirometry sweep speeds (318)</li> </ul>		

## Gas exchange

To familiarize yourself with this parameter and its use with the CARESCAPE modular monitors, study the topics listed as the recommended reading of this User's Manual. The numbers in brackets refer to the page numbers in the manual. As you proceed, mark your completed tasks in the table.

Recommended reading	Completed	Not applicable
GENERAL MEASUREMENT OVERVIEW		
<ul style="list-style-type: none"> <li>Gas exchange warnings (331)</li> </ul>		
<ul style="list-style-type: none"> <li>Gas exchange cautions (332)</li> </ul>		

## Skills checklist

Recommended reading	Completed	Not applicable
<ul style="list-style-type: none"> <li>Gas exchange measurement limitations (332)</li> </ul>		
<ul style="list-style-type: none"> <li>Gas exchange points to note (332)</li> </ul>		
<ul style="list-style-type: none"> <li>Checking the gas exchange measurement (334)</li> </ul>		
<ul style="list-style-type: none"> <li>Gas exchange patient connections with HME/HMEF/filter (333)</li> </ul>		
<ul style="list-style-type: none"> <li>Gas exchange patient connections with flexible tube (333)</li> </ul>		
INTERPRETING GAS EXCHANGE VALUES <ul style="list-style-type: none"> <li>How to interpret the gas exchange values (335)</li> </ul>		
USING THE MEASUREMENT <ul style="list-style-type: none"> <li>Selecting the gas exchange sensor type (334)</li> </ul>		
<ul style="list-style-type: none"> <li>Selecting EE and RQ averaging time (334)</li> </ul>		

## Entropy

To familiarize yourself with this parameter and its use with the CARESCAPE modular monitors, study the topics listed as the recommended reading of this User's Manual. The numbers in brackets refer to the page numbers in the manual. As you proceed, mark your completed tasks in the table.

Recommended reading	Completed	Not applicable
GENERAL MEASUREMENT OVERVIEW <ul style="list-style-type: none"> <li>Entropy warnings (341)</li> </ul>		
<ul style="list-style-type: none"> <li>Entropy cautions (342)</li> </ul>		
<ul style="list-style-type: none"> <li>Entropy measurement limitations (342)</li> </ul>		
<ul style="list-style-type: none"> <li>Entropy points to note (343)</li> </ul>		
<ul style="list-style-type: none"> <li>Entropy indications for use (342)</li> </ul>		
<ul style="list-style-type: none"> <li>Checking the Entropy measurement (344)</li> </ul>		
<ul style="list-style-type: none"> <li>Entropy equipment to patient connection (343)</li> </ul>		
PREPARING FOR THE MEASUREMENT <ul style="list-style-type: none"> <li>Preparing the patient for Entropy measurement (344)</li> </ul>		
USING THE MEASUREMENT <ul style="list-style-type: none"> <li>Selecting the display format for Entropy (345)</li> </ul>		
<ul style="list-style-type: none"> <li>Selecting the Entropy scale (345)</li> </ul>		
<ul style="list-style-type: none"> <li>Selecting the EEG sweep speed (345)</li> </ul>		
SETTING ALARM LIMITS <ul style="list-style-type: none"> <li>Setting Entropy alarm limits (346)</li> </ul>		

## Neuromuscular transmission

To familiarize yourself with this parameter and its use with the CARESCAPE modular monitors, study the topics listed as the recommended reading of this User's Manual.

The numbers in brackets refer to the page numbers in the manual. As you proceed, mark your completed tasks in the table.

Recommended reading	Completed	Not applicable
GENERAL MEASUREMENT OVERVIEW		
• NMT warnings (353)		
• NMT cautions (354)		
• NMT measurement limitations (354)		
• NMT points to note (354)		
• NMT equipment to patient connection (355)		
• Checking the NMT measurement (354)		
PATIENT PREPARATIONS		
• Preparing the patient for NMT measurement (355)		
• Preparing the ElectroSensor setup (356)		
• Preparing the MechanoSensor setup (356)		
• NMT alternative connections (356)		
NMT TRENDS ON SCREEN		
• NMT graphical trends on the monitor screen (357)		
STARTING THE MEASUREMENT		
• Starting the NMT measurement (357)		
CHANGING THE CYCLE TIME		
• Changing the NMT cycle time (358)		
NMT ALTERNATIVE USES		
• NMT alternative connections (356)		

## EEG and AEP

To familiarize yourself with this parameter and its use with the CARESCAPE modular monitors, study the topics listed as the recommended reading of this User's Manual. The numbers in brackets refer to the page numbers in the manual. As you proceed, mark your completed tasks in the table.

Recommended reading	Completed	Not applicable
GENERAL MEASUREMENT OVERVIEW		
• EEG warnings (365)		
• EEG cautions (366)		
• EEG measurement limitations (366)		
• EEG points to note (366)		
• EEG indications for use (366)		
• Checking the EEG measurement (370)		
• EEG equipment to patient connection (367)		

## Skills checklist

Recommended reading	Completed	Not applicable
PREPARING FOR THE MEASUREMENT		
<ul style="list-style-type: none"> <li>Connecting the EEG leadset (368)</li> </ul>		
<ul style="list-style-type: none"> <li>Attaching EEG electrodes within hair area (368)</li> </ul>		
<ul style="list-style-type: none"> <li>Attaching EEG electrodes outside hair area (368)</li> </ul>		
<ul style="list-style-type: none"> <li>Attaching EEG needle electrodes (369)</li> </ul>		
PRECONFIGURED LEADSETS		
<ul style="list-style-type: none"> <li>Preconfigured EEG leadsets (369)</li> </ul>		
<ul style="list-style-type: none"> <li>BASIC montage (369)</li> </ul>		
<ul style="list-style-type: none"> <li>GENERAL montage (370)</li> </ul>		
EEG ON SCREEN		
<ul style="list-style-type: none"> <li>EEG measurement on the monitor screen (370)</li> </ul>		
STARTING THE MEASUREMENT		
<ul style="list-style-type: none"> <li>Starting the EEG measurement (371)</li> </ul>		
USING THE MEASUREMENT		
<ul style="list-style-type: none"> <li>Selecting the EEG scale (371)</li> </ul>		
<ul style="list-style-type: none"> <li>Selecting the EEG sweep speed (371)</li> </ul>		
<ul style="list-style-type: none"> <li>Selecting your own EEG montage (371)</li> </ul>		
<ul style="list-style-type: none"> <li>Defining an EEG montage (373)</li> </ul>		
<ul style="list-style-type: none"> <li>Compressed spectral array (CSA) (375)</li> </ul>		
AUDITORY EVOKED POTENTIALS		
<ul style="list-style-type: none"> <li>Preparing the patient for AEP measurement (379)</li> </ul>		
<ul style="list-style-type: none"> <li>AEP montage (380)</li> </ul>		
<ul style="list-style-type: none"> <li>Starting the AEP measurement (380)</li> </ul>		

## BIS

To familiarize yourself with this parameter and its use with the CARESCAPE modular monitors, study the topics listed as the recommended reading of this User's Manual. The numbers in brackets refer to the page numbers in the manual. As you proceed, mark your completed tasks in the table.

Recommended reading	Completed	Not applicable
GENERAL MEASUREMENT OVERVIEW		
<ul style="list-style-type: none"> <li>BIS warnings (385)</li> </ul>		
<ul style="list-style-type: none"> <li>BIS cautions (386)</li> </ul>		
<ul style="list-style-type: none"> <li>BIS indications for use (387)</li> </ul>		
<ul style="list-style-type: none"> <li>BIS measurement limitations (387)</li> </ul>		
<ul style="list-style-type: none"> <li>BIS points to note (387)</li> </ul>		
<ul style="list-style-type: none"> <li>Checking the BIS measurement (388)</li> </ul>		



Recommended reading	Completed	Not applicable
<ul style="list-style-type: none"> <li>• <a href="#">BIS equipment to patient connection (388)</a></li> </ul>		
<ul style="list-style-type: none"> <li>• <a href="#">Preparing the patient for BIS measurement (388)</a></li> </ul>		
USING THE MEASUREMENT		
<ul style="list-style-type: none"> <li>• <a href="#">Selecting the BIS waveform size (389)</a></li> </ul>		
<ul style="list-style-type: none"> <li>• <a href="#">Selecting the BIS smoothing rate (389)</a></li> </ul>		
<ul style="list-style-type: none"> <li>• <a href="#">Using the automatic BIS sensor check (390)</a></li> </ul>		
<ul style="list-style-type: none"> <li>• <a href="#">Using the manual BIS sensor check (390)</a></li> </ul>		
HOW TO INTERPRET THE VALUES		
<ul style="list-style-type: none"> <li>• <a href="#">How to interpret the BIS values (391)</a></li> </ul>		

Skills checklist





GE Healthcare Finland Oy  
Kuortaneenkatu 2  
FI-00510 Helsinki  
Finland  
Tel: + 358 10 39411  
Fax: + 358 9 1463310  
[www.gehealthcare.com](http://www.gehealthcare.com)

## Headquarters

GE Medical Systems  
*Information Technologies, Inc.*  
8200 West Tower Avenue  
Milwaukee, WI 53223 USA  
Tel: + 1 414 355 5000  
1 800 558 5120 (US only)  
Fax: + 1 414 355 3790

## Asia Headquarters

GE Medical Systems  
*Information Technologies Asia; GE (China) Co., Ltd.*  
No1 Huatuo Road,  
Zhangjiang Hi-tech Park Pudong  
Shanghai P.R.China 201203  
Tel: + 86 21 5257 4650  
Fax: + 86 21 5208 2008

[www.gehealthcare.com](http://www.gehealthcare.com)

